

COMe Eval Carrier T7

User Guide Rev 1.5

Doc.-ID: 1061-5431

Page left intentionally blank



COMe EVAL CARRIER T7 USER GUIDE

Disclaimer

Kontron would like to point out that the information contained in this user guide may be subject to alteration, particularly as a result of the constant upgrading of Kontron products. This document does not entail any guarantee on the part of Kontron with respect to technical processes described in the user guide or any product characteristics set out in the user guide. Kontron assumes no responsibility or liability for the use of the described product(s), conveys no license or title under any patent, copyright or mask work rights to these products and makes no representations or warranties that these products are free from patent, copyright or mask work right infringement unless otherwise specified. Applications that are described in this user guide are for illustration purposes only. Kontron makes no representation or warranty that such application will be suitable for the specified use without further testing or modification. Kontron expressly informs the user that this user guide only contains a general description of processes and instructions which may not be applicable in every individual case. In cases of doubt, please contact Kontron.

This user guide is protected by copyright. All rights are reserved by Kontron. No part of this document may be reproduced, transmitted, transcribed, stored in a retrieval system, or translated into any language or computer language, in any form or by any means (electronic, mechanical, photocopying, recording, or otherwise), without the express written permission of Kontron. Kontron points out that the information contained in this user guide is constantly being updated in line with the technical alterations and improvements made by Kontron to the products and thus this user guide only reflects the technical status of the products by Kontron at the time of publishing.

Brand and product names are trademarks or registered trademarks of their respective owners.

©2021 by Kontron Europe GmbH

Kontron Europe GmbH

Gutenbergstraße 2
85737 Ismaning
Germany
www.kontron.com

Intended Use

THIS DEVICE AND ASSOCIATED SOFTWARE ARE NOT DESIGNED, MANUFACTURED OR INTENDED FOR USE OR RESALE FOR THE OPERATION OF NUCLEAR FACILITIES, THE NAVIGATION, CONTROL OR COMMUNICATION SYSTEMS FOR AIRCRAFT OR OTHER TRANSPORTATION, AIR TRAFFIC CONTROL, LIFE SUPPORT OR LIFE SUSTAINING APPLICATIONS, WEAPONS SYSTEMS, OR ANY OTHER APPLICATION IN A HAZARDOUS ENVIRONMENT, OR REQUIRING FAIL-SAFE PERFORMANCE, OR IN WHICH THE FAILURE OF PRODUCTS COULD LEAD DIRECTLY TO DEATH, PERSONAL INJURY, OR SEVERE PHYSICAL OR ENVIRONMENTAL DAMAGE (COLLECTIVELY, "HIGH RISK APPLICATIONS").

You understand and agree that your use of Kontron devices as a component in High Risk Applications is entirely at your risk. To minimize the risks associated with your products and applications, you should provide adequate design and operating safeguards. You are solely responsible for compliance with all legal, regulatory, safety, and security related requirements concerning your products. You are responsible to ensure that your systems (and any Kontron hardware or software components incorporated in your systems) meet all applicable requirements. Unless otherwise stated in the product documentation, the Kontron device is not provided with error-tolerance capabilities and cannot therefore be deemed as being engineered, manufactured or setup to be compliant for implementation or for resale as device in High Risk Applications. All application and safety related information in this document (including application descriptions, suggested safety measures, suggested Kontron products, and other materials) is provided for reference only.

CAUTION

Handling and operation of the product is permitted only for trained personnel within a work place that is access controlled. Please follow the "General Safety Instructions" supplied with the system.

NOTICE

You find the most recent version of the "General Safety Instructions" online in the download area of this product.

Revision History

Revision	Brief Description of Changes	Date of Issue	Author
1.0	Initial issue	2018-March-26	hjs
1.1	Chapter 5.2.1 Pin 5 corrected	2018-September-10	hjs
1.2	changed block diagram, chapter 5.2.3 added	2018-November-06	hjs
1.3	mistake in chapter 4.1, BMC removed, BIOS flash socket (J19) added	2019-May-22	hjs
1.4	J33/J45 Pinout modified	2019-Dec-04	hjs
1.5	Word2016 issues	2021-April-12	hjs

Terms and Conditions

Kontron warrants products in accordance with defined regional warranty periods. For more information about warranty compliance and conformity, and the warranty period in your region, visit <http://www.kontron.com/terms-and-conditions>.

Kontron sells products worldwide and declares regional General Terms & Conditions of Sale, and Purchase Order Terms & Conditions. Visit <http://www.kontron.com/terms-and-conditions>.

For contact information, refer to the corporate offices contact information on the last page of this user guide or visit our website [CONTACT US](#).

Customer Support

Find Kontron contacts by visiting: <https://www.kontron.de/support-and-services>.

Customer Service

As a trusted technology innovator and global solutions provider, Kontron extends its embedded market strengths into a services portfolio allowing companies to break the barriers of traditional product lifecycles. Proven product expertise coupled with collaborative and highly-experienced support enables Kontron to provide exceptional peace of mind to build and maintain successful products.

For more details on Kontron's service offerings such as: enhanced repair services, extended warranty, Kontron training academy, and more visit <http://www.kontron.com/support-and-services/services>.

Customer Comments

If you have any difficulties using this user guide, discover an error, or just want to provide some feedback, contact [Kontron support](#). Detail any errors you find. We will correct the errors or problems as soon as possible and post the revised user guide on our website.

Symbols

The following symbols may be used in this manual

⚠ DANGER DANGER indicates a hazardous situation which, if not avoided, will result in death or serious injury.

⚠ WARNING WARNING indicates a hazardous situation which, if not avoided, could result in death or serious injury.

NOTICE NOTICE indicates a property damage message.

⚠ CAUTION CAUTION indicates a hazardous situation which, if not avoided, may result in minor or moderate injury.



Electric Shock!
This symbol and title warn of hazards due to electrical shocks (> 60 V) when touching products or parts of products. Failure to observe the precautions indicated and/or prescribed by the law may endanger your life/health and/or result in damage to your material.



ESD Sensitive Device!
This symbol and title inform that the electronic boards and their components are sensitive to static electricity. Care must therefore be taken during all handling operations and inspections of this product in order to ensure product integrity at all times.



HOT Surface!
Do NOT touch! Allow to cool before servicing.



Laser!
This symbol inform of the risk of exposure to laser beam and light emitting devices (LEDs) from an electrical device. Eye protection per manufacturer notice shall review before servicing.



This symbol indicates general information about the product and the user guide.
This symbol also indicates detail information about the specific product configuration.



This symbol precedes helpful hints and tips for daily use.

For Your Safety

Your new Kontron product was developed and tested carefully to provide all features necessary to ensure its compliance with electrical safety requirements. It was also designed for a long fault-free life. However, the life expectancy of your product can be drastically reduced by improper treatment during unpacking and installation. Therefore, in the interest of your own safety and of the correct operation of your new Kontron product, you are requested to conform with the following guidelines.

High Voltage Safety Instructions

As a precaution and in case of danger, the power connector must be easily accessible. The power connector is the product's main disconnect device.

⚠ CAUTION

Warning

All operations on this product must be carried out by sufficiently skilled personnel only.

⚠ CAUTION



Electric Shock!

Before installing a non hot-swappable Kontron product into a system always ensure that your mains power is switched off. This also applies to the installation of piggybacks. Serious electrical shock hazards can exist during all installation, repair, and maintenance operations on this product. Therefore, always unplug the power cable and any other cables which provide external voltages before performing any work on this product.

Earth ground connection to vehicle's chassis or a central grounding point shall remain connected. The earth ground cable shall be the last cable to be disconnected or the first cable to be connected when performing installation or removal procedures on this product.

Special Handling and Unpacking Instruction

NOTICE



ESD Sensitive Device!

Electronic boards and their components are sensitive to static electricity. Therefore, care must be taken during all handling operations and inspections of this product, in order to ensure product integrity at all times.

Do not handle this product out of its protective enclosure while it is not used for operational purposes unless it is otherwise protected.

Whenever possible, unpack or pack this product only at EOS/ESD safe work stations. Where a safe work station is not guaranteed, it is important for the user to be electrically discharged before touching the product with his/her hands or tools. This is most easily done by touching a metal part of your system housing.

It is particularly important to observe standard anti-static precautions when changing piggybacks, ROM devices, jumper settings etc. If the product contains batteries for RTC or memory backup, ensure that the product is not placed on conductive surfaces, including anti-static plastics or sponges. They can cause short circuits and damage the batteries or conductive circuits on the product.

Lithium Battery Precautions

If your product is equipped with a lithium battery, take the following precautions when replacing the battery.

▲ CAUTION

Danger of explosion if the battery is replaced incorrectly.

Replace only with same or equivalent battery type recommended by the manufacturer.

Dispose of used batteries according to the manufacturer's instructions.

General Instructions on Usage

In order to maintain Kontron's product warranty, this product must not be altered or modified in any way. Changes or modifications to the product, that are not explicitly approved by Kontron and described in this user guide or received from Kontron Support as a special handling instruction, will void your warranty.

This product should only be installed in or connected to systems that fulfill all necessary technical and specific environmental requirements. This also applies to the operational temperature range of the specific board version that must not be exceeded. If batteries are present, their temperature restrictions must be taken into account.

In performing all necessary installation and application operations, only follow the instructions supplied by the present user guide.

Keep all the original packaging material for future storage or warranty shipments. If it is necessary to store or ship the product then re-pack it in the same manner as it was delivered.

Special care is necessary when handling or unpacking the product. See Special Handling and Unpacking Instruction.

Quality and Environmental Management

Kontron aims to deliver reliable high-end products designed and built for quality, and aims to complying with environmental laws, regulations, and other environmentally oriented requirements. For more information regarding Kontron's quality and environmental responsibilities, visit <http://www.kontron.com/about-kontron/corporate-responsibility/quality-management>.

Disposal and Recycling

Kontron's products are manufactured to satisfy environmental protection requirements where possible. Many of the components used are capable of being recycled. Final disposal of this product after its service life must be accomplished in accordance with applicable country, state, or local laws or regulations.

WEEE Compliance

The Waste Electrical and Electronic Equipment (WEEE) Directive aims to:

- ▶ Reduce waste arising from electrical and electronic equipment (EEE)
- ▶ Make producers of EEE responsible for the environmental impact of their products, especially when the product become waste
- ▶ Encourage separate collection and subsequent treatment, reuse, recovery, recycling and sound environmental disposal of EEE
- ▶ Improve the environmental performance of all those involved during the lifecycle of EEE



Environmental protection is a high priority with Kontron.

Kontron follows the WEEE directive

You are encouraged to return our products for proper disposal.

Table of Contents

- Disclaimer 3
- Intended Use 4
- Revision History 5
- Terms and Conditions..... 5
- Customer Service 5
- Customer Comments 5
- Symbols..... 6
- Table of Contents 9
- List of Tables..... 10
- List of Figures 10
- 1/ Introduction..... 12**
 - 1.1. Product Description 12
 - 1.2. Product Naming Clarification 13
 - 1.3. Understanding COM Express® Functionality 13
 - 1.4. Block Diagram 14
 - 1.5. COM Express® Documentation..... 15
 - 1.6. COM Express® Benefits 15
- 2/ System specifications 16**
 - 2.1. Component Main Data 16
 - 2.2. Environmental Conditions 17
- 3/ Mainboard Views 18**
 - 3.1. Top View 18
 - 3.2. Front panel 19
- 4/ Mechanical Specification 20**
 - 4.1. Dimensions..... 20
- 5/ Interfaces and Connectors 21**
 - 5.1. External Connectors 21
 - 5.1.1. 10GBase-KR Slot (J10, J11, J12, J13) 21
 - 5.1.2. 1000Base-T connector (J14)..... 22
 - 5.1.3. USB 3.0 Double Connector (J17, J18) 23
 - 5.2. Internal Connectors..... 24
 - 5.2.1. COM Ports (J33, J45) 24
 - 5.2.2. I2C and SMBus (J51, J52)..... 25
 - 5.2.3. PCIe Slots (J3 – J9) 25
 - 5.2.4. GPIO - General Purpose Input and Output (J20)..... 26
 - 5.2.5. Feature Connector (J55) 27
 - 5.2.6. Fan Connector (J47) 28
 - 5.2.7. ATX Power connector (J54)..... 28
 - 5.2.8. ATX Power connector (J53)..... 29
 - 5.2.9. BIOS Flash Socket (J19) 30
- 6/ Accessories 31**
- 7/ Electrical Specification..... 32**
 - 7.1. Supply Voltage 32
 - 7.2. Power Supply Rise time 32
 - 7.3. Supply Voltage Ripple..... 33
- 8/ Features..... 34**
 - 8.1. Rapid Shutdown (SW5)..... 34
 - 8.2. Crowbar implementation details..... 34

8.3. LEDs and indicators.....	35
8.4. Jumper (J27, J28, J29, J30).....	37
8.5. Jumper (J49, J50, J57, J58, J59, J60).....	37
8.6. Jumper (J36, J37, J42, J43, J46).....	38
8.7. Jumper (J22-23, J24-25, J31, J35).....	39
8.8. Jumper (J26, J34).....	40
8.9. Button Switches.....	40
9/ COMe Connector Pin-out List.....	41
10/ Technical Support.....	46
10.1. Warranty.....	46
10.2. Returning Defective Merchandise.....	46
List of Acronyms.....	48
About Kontron – Member of the S&T Group.....	49

List of Tables

Table 1: Features.....	13
Table 2: Component Main Data.....	16
Table 3: Environmental Conditions.....	17
Table 4: COMe Ports.....	21
Table 5: 10GBase-KR Slot with SFP+ interface.....	21
Table 6: 1000Base-T connector.....	22
Table 7: Signals.....	22
Table 8: USB 3.0 Double Connector.....	23
Table 9: COM Ports with 10 pins.....	24
Table 10: COM Ports with 10 pins.....	24
Table 11: I2C Header.....	25
Table 12: SMBus Header.....	25
Table 13: PCIe Slots.....	25
Table 14: GPIO Header with 10 pins.....	27
Table 15: Feature Connector with 24 pins.....	27
Table 16: Fan Connector with 4 pins.....	28
Table 17: : ATX Power connector with 24 pins.....	28
Table 18: ATX Power connector with 4 pins.....	29
Table 19: BIOS Flash Socket Pinout.....	30
Table 20: Product Specific Accessories List.....	31
Table 21: General Accessories List.....	31
Table 22: LED Colors.....	35
Table 23: LEDs.....	35
Table 24: 10G LEDs, see Front Panel 0.....	36
Table 25: Jumper 27 to 30.....	37
Table 26: Jumper J49, J50, J57, J58, J59, J60.....	37
Table 27: Jumper J36, J37, J42, J43, J46.....	38
Table 28: Jumper J22-23, J24-25, J31, J35.....	39
Table 29: Jumper J26, J34.....	40
Table 30: LEDs.....	40
Table 31: Pin-out List.....	41

List of Figures

Figure 1: COMe Eval Carrier T7 with seven PCIe slots.....	12
Figure 2: Block Diagram COMe-Type7 Validation/Evaluation carrier.....	14
Figure 3: Top View of COMe Eval Carrier T7.....	18
Figure 4: Front Panel.....	19
Figure 5: Board Dimensions.....	20

- Figure 6: 10GBase-KR Slot with SFP+ interface21
- Figure 7: 1000Base-T connector.....22
- Figure 8: USB 3.0 Double Connector23
- Figure 9: COM Ports with 10 pins (J33).....24
- Figure 10: COM Ports with 10 pins (J45).....24
- Figure 11: I2C and SMBus header with four pins.....25
- Figure 12: Configuring GPIO Pins using JIDA32/K-Station.....26
- Figure 13: GPIO Header with 10 pins27
- Figure 14: Feature Connector with 24 pins.....27
- Figure 15: Fan Connector with 4 pins.....28
- Figure 16: ATX Power connector with 24 pins.....28
- Figure 17: ATX Power connector with 4 pins.....29
- Figure 18: BIOS Flash Socket30
- Figure 19: Power Supply ATX 24-pin for Carrier Board (J54)33
- Figure 20: LEDs, see board position 12, LED "All_RUN_PsUs_OK" in red circle.....35
- Figure 21: Jumper 27 to 30.....37
- Figure 22: Jumper J49, J50, J57, J58, J59, J6037
- Figure 23: Jumper J36, J37, J42, J43, J46.....38
- Figure 24: Jumper J22-23, J24-25, J31, J3539
- Figure 25: Jumper J26, J3440
- Figure 26: Button Switches, see board position 1440
- Figure 27: COMe Connector with 220 pins.....41
- Figure 28: COMe Connector Pinout.....41

1/ Introduction

1.1. Product Description

The COMe Eval Carrier T7 is being developed as an evaluation, testing and validation carrier board (baseboard) in ATX form factor for COMe-bBD7 COM Express® modules. It offers a testing platform for the COM-bBD7 module with the latest Intel processor family and a huge variety of interfaces. Main purpose of this carrier board is to bring out all the signals from COM Express® connector of COMe Type7 modules to industry standard interfaces. The key features are:

- ▶ 4x 10GBase-KR interface, directly from COMe module
- ▶ 1x 1000Base-T interface, directly from COMe module with basic EMI/ESD protection in RJ-45 integrated-magnetic connector
- ▶ 4x USB 3.0 Interface, directly from COMe module with basic EMI/ESD protection
- ▶ 7x PCIe slot (1x16 + 1x8 + 1x4 + 4x1)
- ▶ Board management controller add-in card in one of the PCIe slots
- ▶ Support for NC-SI interface for remote management evaluation
- ▶ 2x SATA standard interface, directly from COMe module
- ▶ 2x High speed UART interfaces, directly from module on pin header and with MAX3232 redriver for performance validation with standard cabling and interfacing at the same time as jumper option
- ▶ External fan connector
- ▶ Coin cell and supercapacitor options for RTC measurements
- ▶ BIOS POST Code display in the form of 7-Segment display array
- ▶ Pin headers for COM Express® specific signals enabling measurement like GPIOs, I2C, SMBus and Feature connector
- ▶ External BIOS flash socket

Figure 1: COMe Eval Carrier T7 with seven PCIe slots

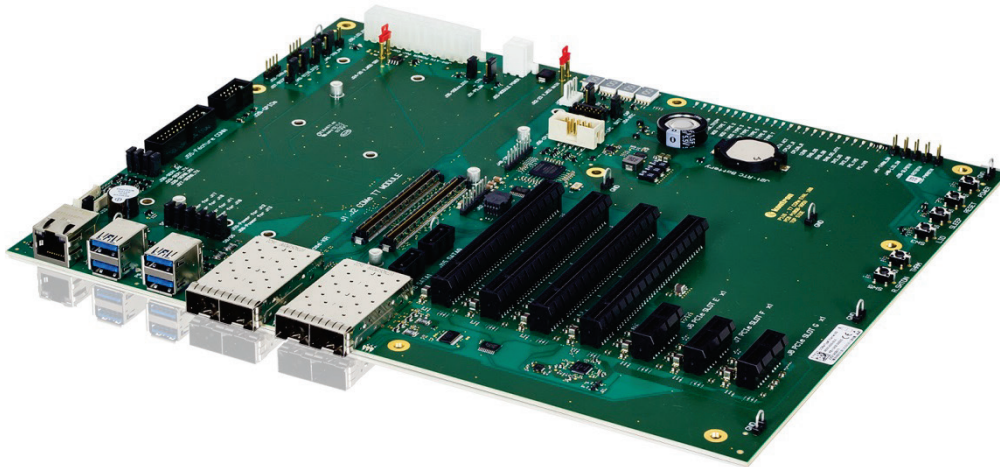

1.2. Product Naming Clarification

The product names for Kontron COM Express® Computer-on-Modules consist of a short form of the industry standard (COMe-), the form factor (b=basic, c=compact, m=mini), the capital letters for the CPU and Chipset Codenames (XX) and the pin-out type (#) followed by the CPU Name.

COM Express® defines a Computer-On-Module, or COM, with all components necessary for a bootable host computer, packaged as a super component.

- ▶ COMe-bXX# modules are Kontron's COM Express® modules in basic form factor (125 mm x 95 mm)
- ▶ COMe-cXX# modules are Kontron's COM Express® modules in compact form factor (95 mm x 95 mm)
- ▶ COMe-eXX# modules are Kontron's COM Express® modules in extended form factor (155 mm x 110 mm)

The COMe Eval Carrier T7 fits all three types of modules.

1.3. Understanding COM Express® Functionality

All Kontron COM Express® extended, basic and compact modules contain two 220pin connectors; each of it has two rows called Row A & B on primary connector and Row C & D on secondary connector. The COM Express® Computer-On-Module (COM) features the following maximum amount of interfaces according to the PCI Industrial Computer Manufacturers Group (PICMG) module Pin-out type.

Table 1: Features

Feature	COMe Eval Carrier T7
10 Gbit Ethernet	4x
Serial ATA	2x
PCI Express x16	1x
PCI Express x8	1x
PCI Express x4	1x
PCI Express x1	4x
USB 3.0	4x
GPIO	8x
FAN PWM out	1x

1.4. Block Diagram

Figure 2: Block Diagram COME-Type7 Validation/Evaluation carrier

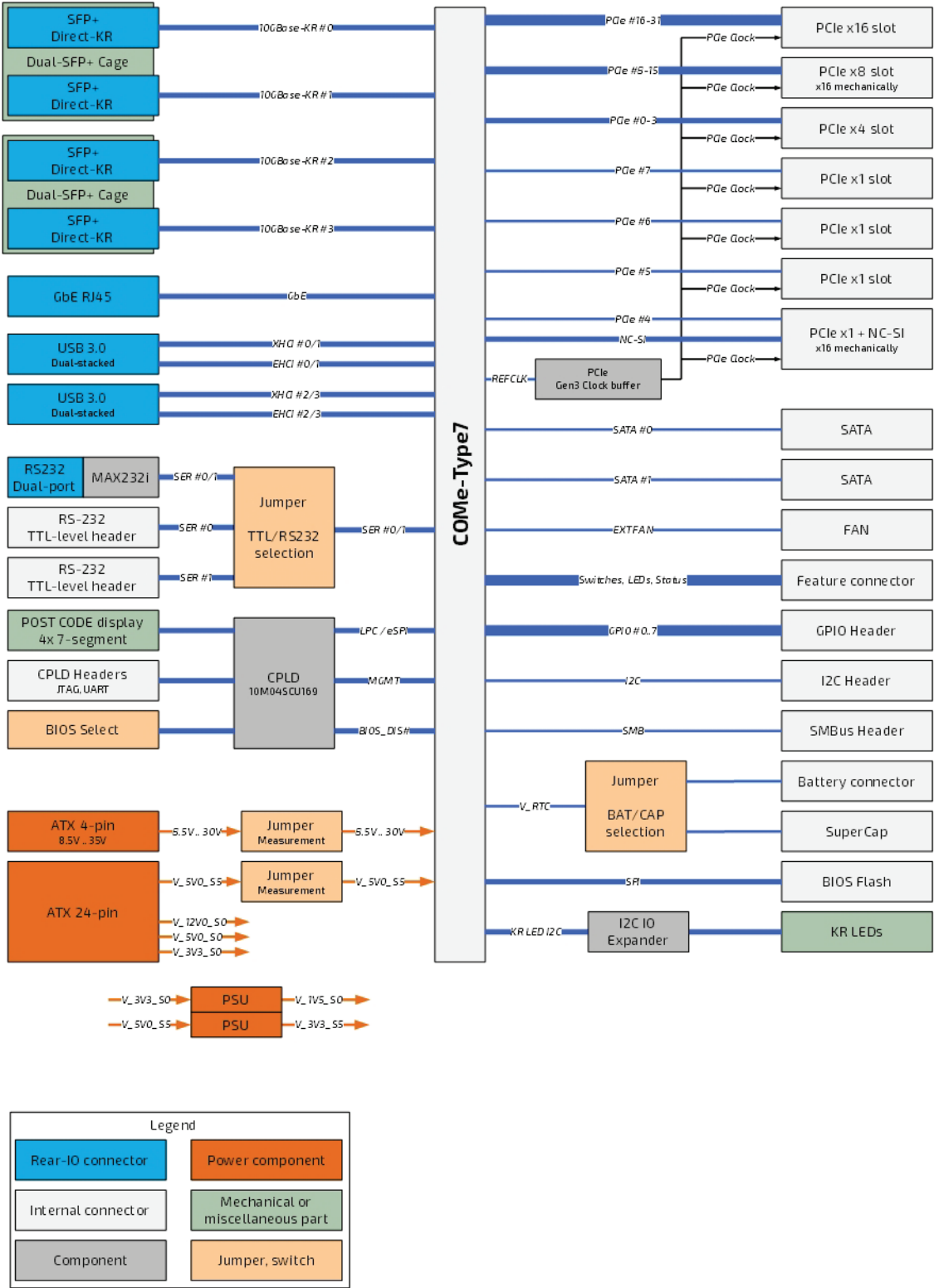

1.5. COM Express® Documentation

The COM Express® Specification defines the COM Express® module form factor, pin-out, and signals. This document is available at the PICMG® website by filling out the order form.

1.6. COM Express® Benefits

COM Express® modules are compact and highly integrated computers. All modules feature a standardized form factor and connector layout which carry a specified set of signals. Each COM is based on the COM Express® specification. This standardization allows designers to create a single-system baseboard that can accept present and future COM Express® modules.

The baseboard designer can optimize exactly how each of these functions implements physically. Designers can place connectors precisely where needed for the application on a baseboard designed to optimally fit a system's packaging.

A single baseboard design can use a range of COM Express® modules with different sizes and pin-outs. This flexibility can differentiate products at various price/performance points. The modularity of a COM Express® solution also ensures against obsolescence when computer technology evolves. A properly designed COM Express® baseboard can work with several successive generations of COM Express® modules.

A COM Express® baseboard design has many advantages of a customized computer-board design and, additionally, delivers better obsolescence protection, heavily reduced engineering effort, and faster time to market.

2/ System specifications

2.1. Component Main Data

The table below summarizes the features of the motherboard.

Table 2: Component Main Data

COMe Eval Carrier T7	
Form factor	Testing Hardware with 244.0 mm x 305.0 mm
Memory	
EEPROM System (U17)	PICMG EEPROM
External I/O	
LAN	4x Gbit-Ethernet ports and 1x GE port
USB	4x USB 3.0 double stack
Internal I/O	
SATA	2x standard slots
Feature Connector	one connector with 2x12 pins
PCIe	1x x16, 1x x8, 1x x4, 4x x1
LEDs	SMD LEDs e.g. for carrier activity, board status, LAN and power status (power good)
GPIO	GPIO Header 2x5 pins
SMBus header	4-pin header
I2C	4-pin header
Battery	1.5 F Supercapacitator and CR2032 battery holder parallel, support for dual use
Fan	4-pin fan connector, Voltage can be 5 V or 12 V (default)
Board management with PCI x1 interface	
NC-SI	Network controller sideband interface
Power supplies Signals	resets, suspend information signals, wake signals
Carrier Board Power	
Power input	Carrier is powered from standard ATX power supply with ATX 24pin connector.
Single Supply Support	carrier requires ATX power
ACPI	ACPI 4.0
S-States	S0, S4, S5
S5 Eco Mode	yes
Misc Power Management	yes
Kontron Features	
External I2C Bus	Fast I2C, MultiMaster capable
M.A.R.S. support	no
Embedded API	KEAPI3
Custom BIOS Settings/Flash Backup	yes
Watchdog support	Triple Staged
Miscellaneous	
Miscellaneous	2x UART/PWM FAN

▲ CAUTION

Danger of explosion if the lithium battery is incorrectly replaced.

- ▶ Replace only with the same or equivalent type recommended by the manufacturer
- ▶ Dispose of used batteries according to the manufacturer's instructions

2.2. Environmental Conditions

Table 3: Environmental Conditions

Operating	-40°C to +85°C Some connectors and supercap has operating temperature only 0°C to +70°C, relative humidity (non-condensing) 10 % to 93 % at 40°C
Storage	-40°C to +85°C relative humidity (non-condensing) 10 % to 93 % at 40°C
Waste Electrical and Electronic Equipment (WEEE)	Components and materials of the product must not contain lead, mercury, cadmium, hexavalent, chromium, polybrominated biphenyls (PBB) or polybrominated diphenyl ethers (PBDE). (Directive 2002/95/EC)
RoHS II Compliance	The product will comply with the European Council Directive on the approximation of the laws of the member states relating to Directive 2011/65/EU or the last status thereof.
Theoretical MTBF	not applicable
Compliance	<ul style="list-style-type: none"> ▶ CE marked according to low voltage directive 2006/95/EC EN60950 ▶ Safety Component Recognition to UL60950-1 ▶ EMC according to EN55022 class B in reference system ▶ Reach compliance

3/ Mainboard Views

3.1. Top View

Figure 3: Top View of COMe Eval Carrier T7

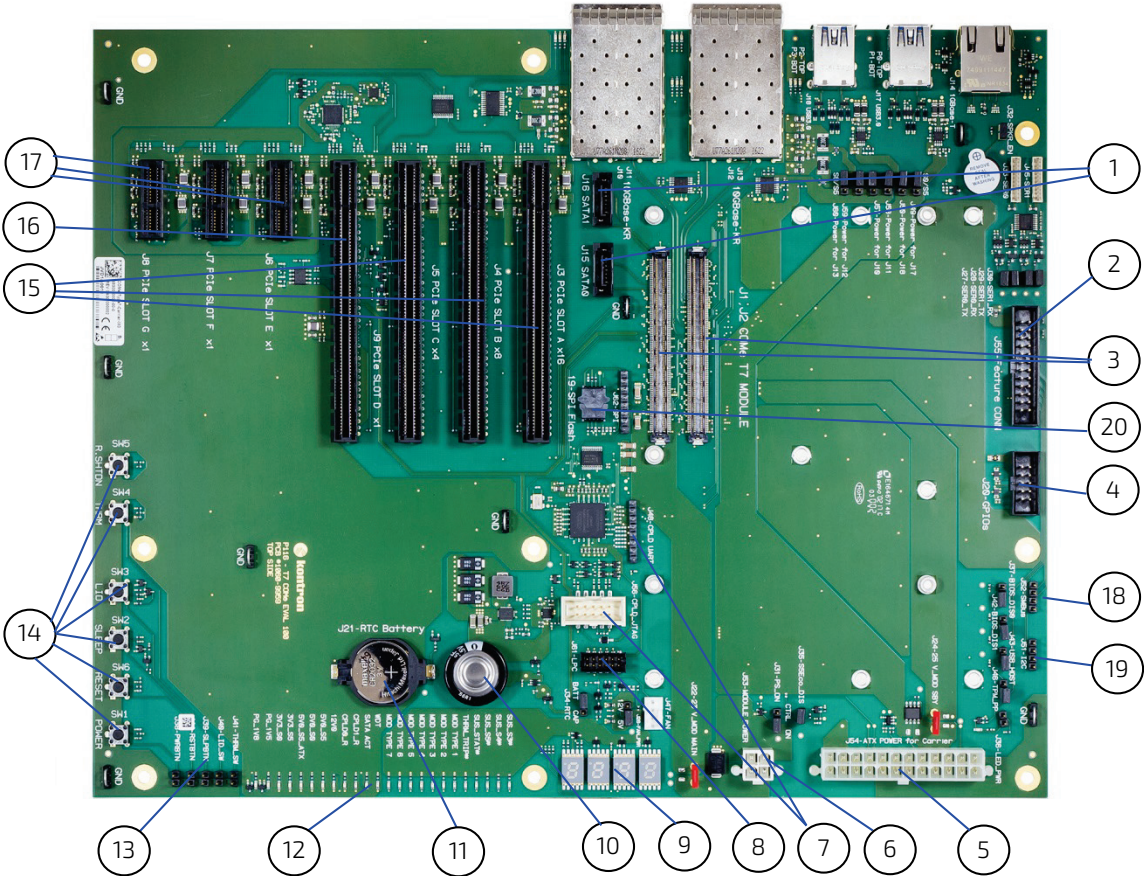

- | | |
|--|--|
| 1. 2x SATA (J15/J16) | 11. Battery (J21) |
| 2. Feature Connector (J55) | 12. LEDs |
| 3. 2x COMe interface (J1/J2) | 13. Jumper (J38-J41) |
| 4. GPIO (J20) | 14. Button Switches (SW1-SW6) |
| 5. ATX power connector 24 pins (J54) | 15. PCIe Slots (x16 (J3), x8 (J4), x4 (J5)) |
| 6. ATX power connector 4 pins (J53) | 16. PCIe x1 slot D with NC-SI interface (J9) |
| 7. CPLD JTAG (2x5 pins, J56) and CPLD UART (8 pins, J48) | 17. PCIe Slot E x1 (J6) |
| 8. LPC (J61) | 18. SMBus (J52) |
| 9. POST Code Display | 19. I2C (J51) |
| 10. RTC Supercapacitor | 20. BIOS Flash Socket |

3.2. Front panel

Figure 4: Front Panel

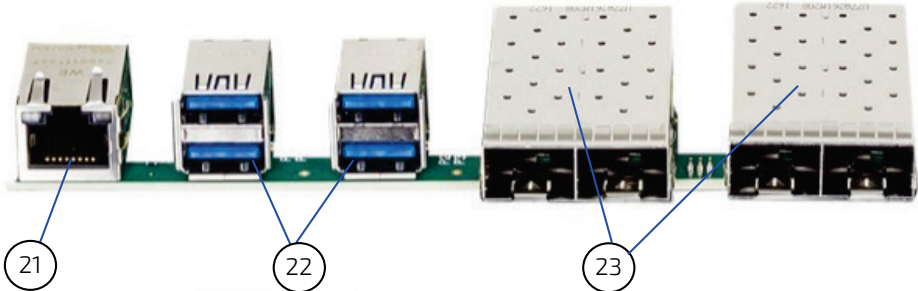

- 21. 1x GE Connector (J14)
- 22. 4x USB 3.0 (J17/J18)
- 23. 4x 10GE Connectors (J10, J11, J12, J13)

4/ Mechanical Specification

4.1. Dimensions

The dimensions of the carrier board (see Figure 5) are 244.0 mm x 305.0 mm.

Figure 5: Board Dimensions

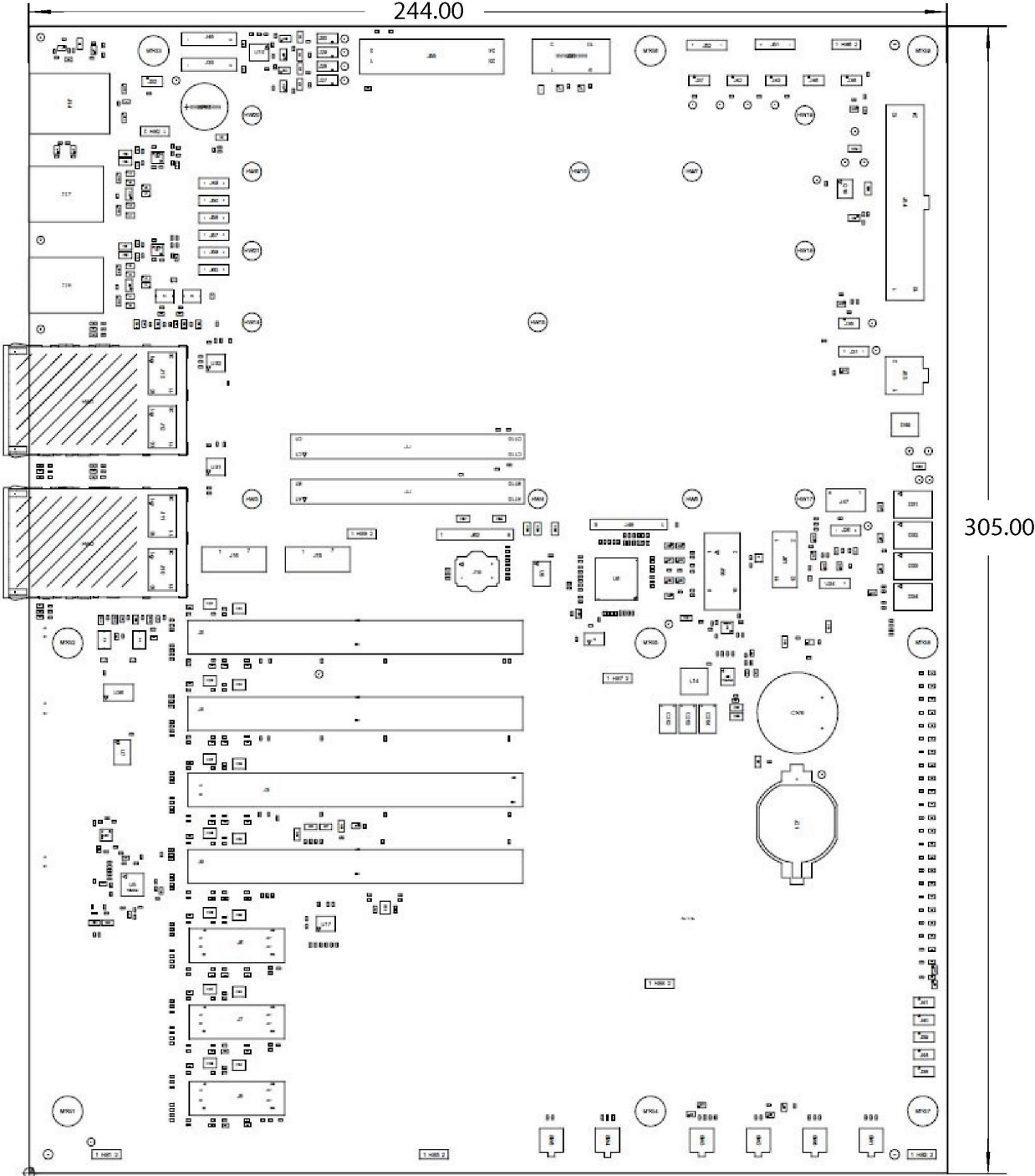

5/ Interfaces and Connectors

5.1. External Connectors

5.1.1. 10GBase-KR Slot (J10, J11, J12, J13)

Figure 6: 10GBase-KR Slot with SFP+ interface

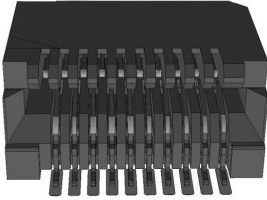

Table 4: COMe Ports

COMe Port	Connector
COMe LAN Port 0	J10
COMe LAN Port 1	J11
COMe LAN Port 2	J12
COMe LAN Port 3	J13

Table 5: 10GBase-KR Slot with SFP+ interface

Pin	Type	Signal
1	VeeT	Transmitter ground
2	TxFault	Transmitter fault indication
3	TxDisable	Optical output disabled when high
4	MOD-DEF(2)	Data for serial ID interface
5	MOD-DEF(1)	Clock for serial ID interface
6	MOD-DEF(0)	Grounded by the module to indicate module presence
7	RateSelect	Low selects reduced bandwidth
8	LOS	When high, indicates received optical power below worst-case receiver sensitivity
9	VeeR	Receiver ground
10	VeeR	Receiver ground
11	VeeR	Receiver ground
12	RD-	Inverted received data
13	RD+	Received data
14	VeeR	Receiver ground
15	VccR	Receiver power (3.3 V, max. 300 mA)
16	VccT	Transmitter power (3.3 V, max. 300 mA)
17	VeeT	Transmitter ground
18	TD+	Transmit data

Pin	Type	Signal
19	TD-	Inverted transmit data
20	VeeT	Transmitter ground

5.1.2. 1000Base-T connector (J14)

Figure 7: 1000Base-T connector

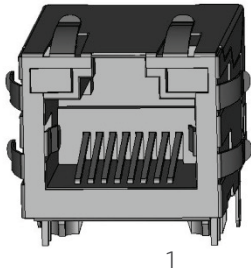

Table 6: 1000Base-T connector

Pin	Signal	Ethernet 10 BaseT/100BaseT	Gigabit-Ethernet
1	MDI0+	TX+	DA+
2	MDI0-	TX-	DA-
3	MDI1+	RX+	DB+
4	MDI1-		DC+
5	MDI2+		DC-
6	MDI2-	RX-	DB-
7	MDI3+		DD+
8	MDI3-		DD-

Table 7: Signals

LED	Signal
1	green, activity
2	green, 100 MB/s
2	yellow, 1000 MB/s

5.1.3. USB 3.0 Double Connector (J17, J18)

Figure 8: USB 3.0 Double Connector

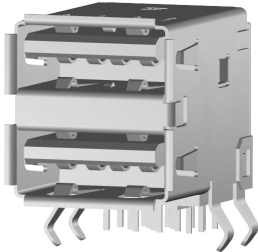

Table 8: USB 3.0 Double Connector

Pin	Signal	Remark
1	+5V	Low, Full & High Speed (USB 2.0) contact pins Bottom con. Note: Square-shaped PCB copper pad denotes Pin10 location instead of Pin1 on board revisions A0 and A1.
2	USB Data -	
3	USB Data +	
4	GND	
5	USB SSRX-	Super Speed (USB3.0) contact pins Bottom con.
6	USB SSRX+	
7	GND	
8	USB SSTX-	
9	USB SSTX+	Low, Full & High Speed (USB 2.0) contact pins Top con.
10	VBUS +5V (900mA max.)	
11	USB Data -	
12	USB Data +	
13	GND	Super Speed (USB3.0) contact pins Top con.
14	USB SSRX-	
15	USB SSRX+	
16	GND	
17	USB SSTX-	
18	USB SSTX+	
Shield	Shield	

5.2. Internal Connectors

5.2.1. COM Ports (J33, J45)

Figure 9: COM Ports with 10 pins (J33)

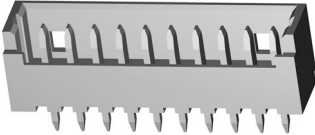

Table 9: COM Ports with 10 pins

Pin	Signal
1	NC
2	NC
3	NC
4	NC
5	NC
6	TX
7	NC
8	RX
9	NC
10	NC

Figure 10: COM Ports with 10 pins (J45)

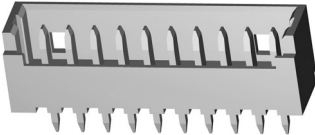

Table 10: COM Ports with 10 pins

Pin	Signal
1	+5 V
2	GND
3	NC
4	NC
5	NC
6	TX
7	NC
8	RX
9	NC
10	NC

5.2.2. I2C and SMBus (J51, J52)

The I2C Interface supports clock from 127 Hz to 400 kHz (limited by on board devices and capacitive loading) and can be configured in Setup.

Figure 11: I2C and SMBus header with four pins



Table 11: I2C Header

Pin	Description
1	V_3V3_S5
2	I2C_DAT
3	I2C_CLK
4	GND

Table 12: SMBus Header

Pin	Description
1	V_V3V_S5
2	SMB_DAT
3	SMB_CLK
4	GND

5.2.3. PCIe Slots (J3 – J9)

Table 13: PCIe Slots

PCIe Lanes	Connector	PCIe Slot
0 - 3	J5	PCIe x4 – Slot C (PCIe x16 mechanic)
4	J9	PCIe x1 – Slot D (PCIe x16 mechanic)
5	J6	PCIe x1 – Slot E (PCIe x1 mechanic)
6	J7	PCIe x1 – Slot F (PCIe x1 mechanic)
7	J8	PCIe x1 – Slot G (PCIe x1 mechanic)
8 - 15	J4	PCIe x8 – Slot B (PCIe x16 mechanic)
16 - 31	J3	PCIe x16 – Slot A (PCIe x16 mechanic)

5.2.4. GPIO - General Purpose Input and Output (J20)

The COMe-bBD7 offers four General Purpose Input (GPI) pins and four General Purpose Output (GPO) pins. On a 3.3V level, digital inputs and outputs are available.

Figure 12: Configuring GPIO Pins using JIDA32/K-Station



The GPI and GPO pins can be configured using JIDA32/K-Station.



Please refer to the JIDA32/K-Station manual in the driver download packet on our EMD Customer Section.

Figure 13: GPIO Header with 10 pins

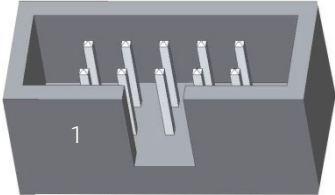

Table 14: GPIO Header with 10 pins

Pin	Signal	Pin	Signal
P1	V_3V3_S0	P2	GPO0
P3	GPI0	P4	GPO1
P5	GPI1	P6	GPO2
P7	GPI2	P8	GPO3
P9	GPI3	P10	Ground

5.2.5. Feature Connector (J55)

Figure 14: Feature Connector with 24 pins

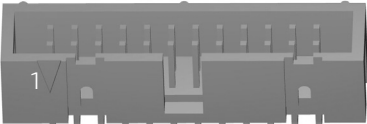

Table 15: Feature Connector with 24 pins

Pin	Signal	Pin	Signal
P1	V_5V0_S0	P2	GPO
P3	BATLOW#	P4	GPI
P5	SYS_RESET#	P6	WDT
P7	LPC_SERIRQ	P8	NC
P9	I2C_DAT	P10	SMB_ALERT#
P11	I2C_CLK	P12	SMB_DAT
P13	SMB_CLK	P14	NC
P15	WAKE#	P16	V_3V0_RTC
P17	THRM#	P18	GND
P19	PWR_OK	P20	GND
P21	PWRBTN#	P22	GND
P23	SATA_ACT#	P24	CB_RESET#

5.2.6. Fan Connector (J47)

Figure 15: Fan Connector with 4 pins

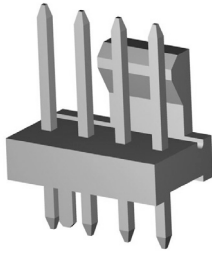

Table 16: Fan Connector with 4 pins

Pin	Description
1	GND
2	Power (12V/5V switchable)
3	TACH (sense)
4	PWM (drive)

5.2.7. ATX Power connector (J54)

Figure 16: ATX Power connector with 24 pins

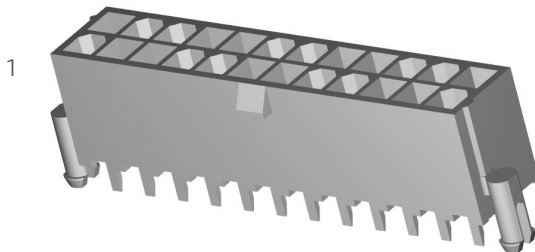

Table 17: : ATX Power connector with 24 pins

Pin	Signal	Cable Colour
1	3,3 V	Orange
2	3,3 V	Orange
3	GND	Black
4	5 V	Red
5	GND	Black
6	5 V	Red
7	GND	Black
8	PWR_OK	Grey
9	5 VSB	Purple
10	12 V	Yellow
11	12 V	Yellow

Pin	Signal	Cable Colour
12	3,3 V	Orange
13	3,3 V	Orange
14	-12 V	Blue
15	GND	Black
16	PS ON	Green
17	GND	Black
18	GND	Black
19	GND	Black
20	-5 V	White
21	5 V	Red
22	5 V	Red
23	5 V	Red
24	GND	Black

5.2.8. ATX Power connector (J53)

Figure 17: ATX Power connector with 4 pins

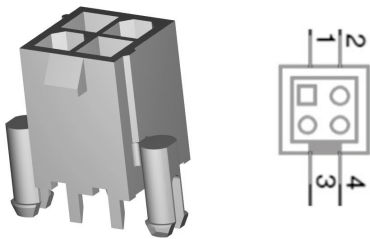

Table 18: ATX Power connector with 4 pins

Pin	Signal
1	GND
2	GND
3	DC12V
4	DC12V

5.2.9. BIOS Flash Socket (J19)

Figure 18: BIOS Flash Socket

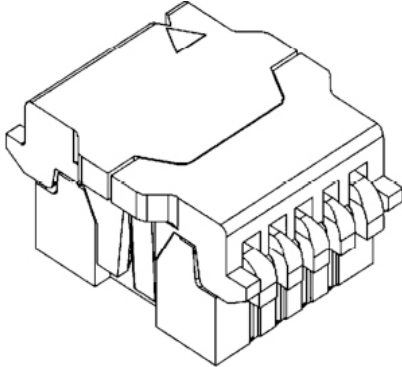

Table 19: BIOS Flash Socket Pinout

Pin	Signal	Pin	Signal
1	CS#	5	SIN/I00
2	SOUT/I01	6	SCLK
3	WP#/I02	7	HOLD#/I03/RST
4	GND	8	V_VCC

6/ Accessories

Table 20: Product Specific Accessories List

Product Number	Adapter Cards	Description
68300-0000-01-0	ADA-COME-T7 4X10G KR-RJ45	COMe Type 7 Interposer Card, 4x 10GbE RJ45 adapter to be used in combination with COMe Eval Carrier T7
68300-0000-03-0	ADA-COME-T7 4X10G KR-SFP+	COMe Type 7 Interposer Card, 4x 10GbE SFP+ adapter to be used in combination with COMe Eval Carrier T7

Table 21: General Accessories List

Product Number	Mounting	Description
38017-0000-00-5	COMe Mount KIT 5mm 1set	Mounting Kit for 1 module including screws for 5mm connectors
38017-0000-00-0	COMe Mount KIT 8mm 1set	Mounting Kit for 1 module including screws for 8mm connectors
Product Number	Cables	Description
96079-0000-00-0	KAB-HSP 200mm	Cable adapter to connect FAN to module (COMe basic/compact)
96079-0000-00-2	KAB-HSP 40mm	Cable adapter to connect FAN to module (COMe basic/compact)
96061-0000-00-0	KAB-DSUB9-3	Adapter cable from 10pin molex connector to DSUB9 male connector

7/ Electrical Specification

7.1. Supply Voltage

- ▶ one ATX Main Power 24pin



Power supply for the module: the ATX_12V P4 connector provides a wide range of input, depending on module specification

7.2. Power Supply Rise time

- ▶ The input voltages shall rise from $\leq 10\%$ of nominal to within the regulation ranges within 0.1ms to 20ms.
- ▶ There must be a smooth and continuous ramp of each DC input voltage from 10% to 90% of its final set-point following the ATX specification

NOTICE

If any of the supply voltages drops below the allowed operating level longer than the specified hold-up time, all the supply voltages should be shut down and left OFF for a time long enough to allow the internal board voltages to discharge sufficiently. If the OFF time is not observed, parts of the board or attached peripherals may work incorrectly or even suffer a reduction of MTBF. The minimum OFF time depends on the implemented PSU model and other electrical factors and needs to be measured individually for each case.

7.3. Supply Voltage Ripple

Figure 19: Power Supply ATX 24-pin for Carrier Board (J54)

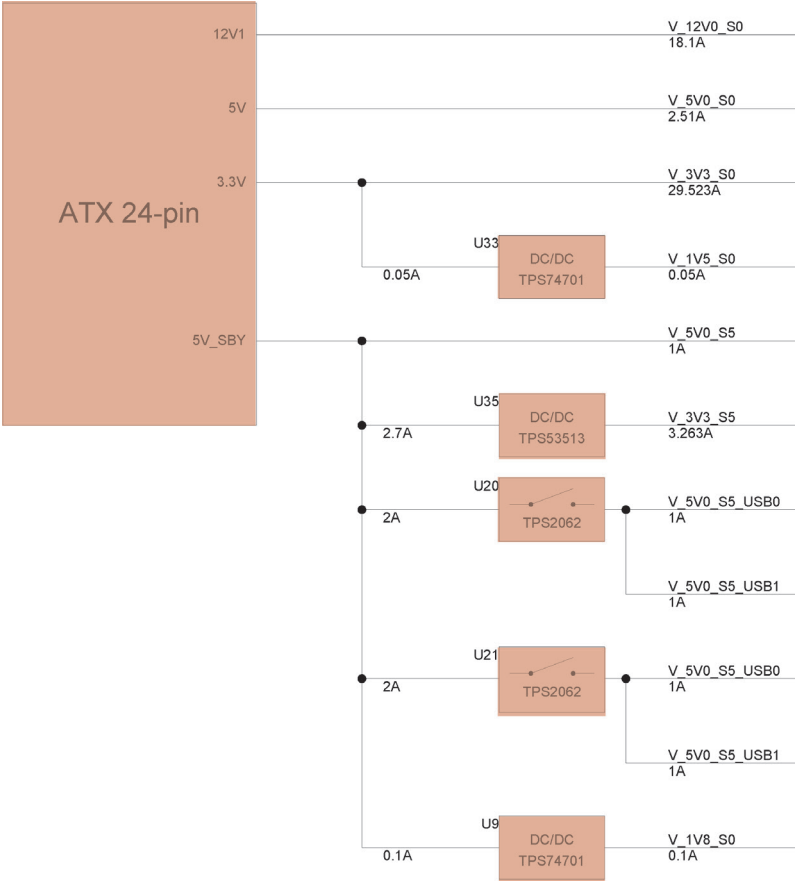

Maximum 100 mV peak to peak is 0 - 20MHz.

8/ Features

8.1. Rapid Shutdown (SW5)

Kontron has implemented a rapid shutdown function. It works as follows:

1. An active-high shutdown signal is asserted by the COMe Eval Type T7 carrier board through button switch SW5. The characteristics of the shutdown signal are as follows:
 - ▶ Amplitude 5.0V +/- 5%
 - ▶ Source impedance < = 50 ohms
 - ▶ Rise time $\leq 1 \mu\text{s}$
 - ▶ Duration $\geq 20 \mu\text{s}$

The assertion of this signal causes all power regulators to be disabled and the internal power supply rails to be discharged by crowbar circuits. The shutdown circuitry provides internal energy storage that maintains crowbar activation for at least 2 ms following the de-assertion of the shutdown signal.

2. Simultaneously with the leading edge of shutdown, the 12 V (main) input power to the module is removed and these input power pins are externally clamped to ground through a crowbar circuit located on the COM Express carrier board. This external clamping circuit must maintain a maximum resistance of approximately 1 ohm and be activated for a minimum of 2 ms.
3. Simultaneously with the leading edge of shutdown, the 5 V (standby) input power to the module is removed, if present. External clamping on these pins is not necessary (but recommended) because it is clamped through the module by the main 12 V rail.

8.2. Crowbar implementation details

Simultaneously with the leading edge of shutdown, the 12 V (main) input power to the module is removed and these input power pins are externally clamped to ground through a crowbar circuit (external to COMe Carrier Board ADT7). This external clamping circuit must maintain a maximum resistance of approximately 1 Ohm and be activated for a minimum of 2 ms.

Simultaneously with the leading edge of shutdown, the 5 V (standby) input power to the module is removed, if present. External clamping on these pins is not necessary (but recommended) because it is clamped through the module by the main 12 V rail.

8.3. LEDs and indicators

Indicators and LEDs indicate only presence of voltage on certain signal, but not necessarily a correct shape and level of the voltage. This is important especially for power supplies – power good signal would provide more accurate indication, but it is not possible to provide this for all signals (for example ATX power signals share one power good).

Table 22: LED Colors

LED color	Function
Green	Power rail
Red	Management
Yellow	Information/10 G Ethernet

Figure 20: LEDs, see board position 12, LED "ALL_RUN_PSUs_OK" in red circle

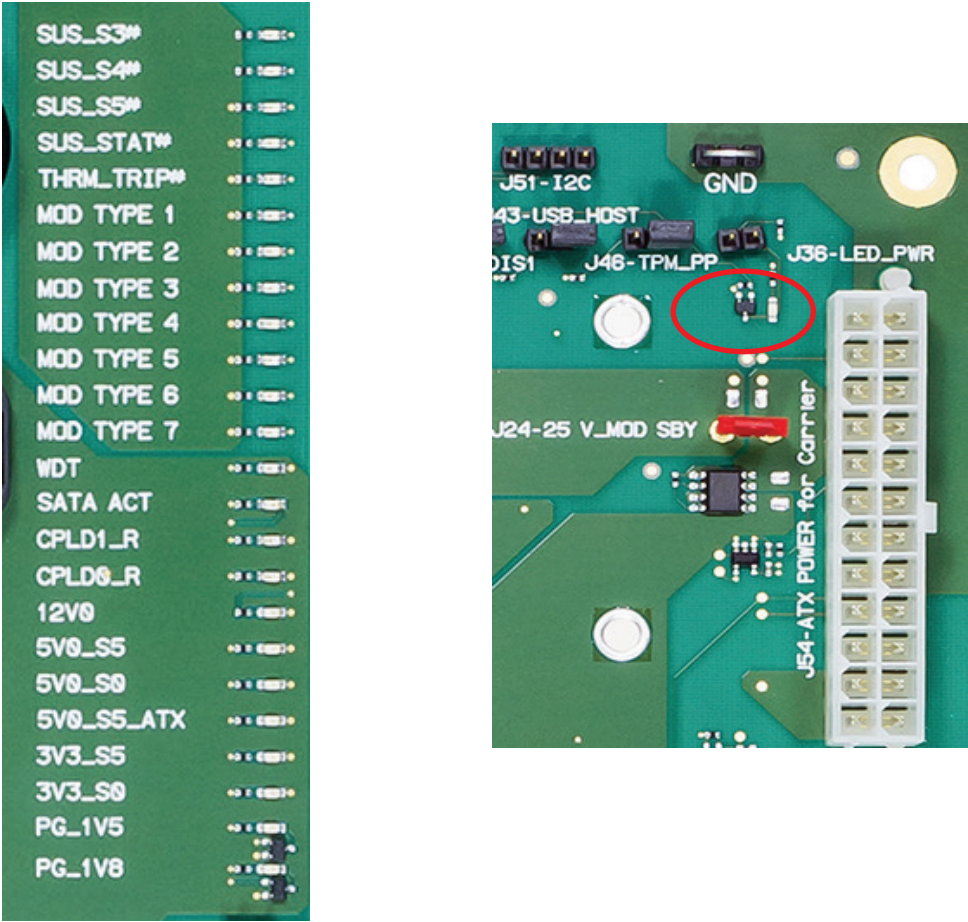

Table 23: LEDs

Reference designator	Indicator	Color A	Color B
D1	SUS S3#	[OFF] Signal inactive	[Red] Signal active (low)
D2	SUS S4#	[OFF] Signal inactive	[Red] Signal active (low)
D3	SUS S5#	[OFF] Signal inactive	[Red] Signal active (low)

Reference designator	Indicator	Color A	Color B
D4	SUS STAT#	[OFF] Signal inactive	[Red] Signal active (low)
D6	THRMTRIP#	[OFF] Signal inactive	[Red] Signal active (low)
D7	Type 1	[OFF] Signal inactive	[Red] Module is type 1
D8	Type 2	[OFF] Signal inactive	[Red] Module is type 2
D9	Type 3	[OFF] Signal inactive	[Red] Module is type 3
D10	Type 4	[OFF] Signal inactive	[Red] Module is type 4
D11	Type 5	[OFF] Signal inactive	[Red] Module is type 5
D12	Type 6	[OFF] Signal inactive	[Red] Module is type 6
D13	Type 7	[OFF] Signal inactive	[Red] Module is type 7
D5	WDT	[OFF] Signal inactive	[Red] Signal active (high)
D22	SATA ACT#	[OFF] Signal inactive	[Yellow] SATA Activity
D23	CPLD LED0	[OFF] Debug inactive	[Yellow] Debug active
D24	CPLD LED1	[OFF] Debug inactive	[Yellow] Debug active
D14	Carrier 12.0V RUN	[OFF] Rail off	[Green] Rail running
D18	Carrier 5.0V STBY	[OFF] Rail off	[Green] Rail running
D15	Carrier 5.0V RUN	[OFF] Rail off	[Green] Rail running
D20	ATX 5.0V STBY	[OFF] Rail off	[Green] Rail running
D17	Carrier 3.3V STBY	[OFF] Rail off	[Green] Rail running
D16	Carrier 3.3V RUN	[OFF] Rail off	[Green] Rail running
D19	Carrier 1.5V RUN	[OFF] Rail off	[Green] Rail running
D48	Carrier 1.8V STBY	[OFF] Rail off	[Green] Rail running
D21	All RUN PSUs OK	[OFF] Rail off	[Green] Rail running

Table 24: 10G LEDs, see Front Panel 0

Reference designator	Indicator	Color A	Color B
D47	10G Port0 ACT#	[OFF] Signal inactive	[Yellow] 10G Port0 Activity
D46	10G Port0 LinkSpdMax#	[OFF] Signal inactive	[Yellow] 10G Port0 Link speed at maximum
D45	10G Port0 LinkSpd#	[OFF] Signal inactive	[Yellow] 10G Port0 Link speed indication
D44	10G Port1 ACT#	[OFF] Signal inactive	[Yellow] 10G Port0 Activity
D43	10G Port1 LinkSpdMax#	[OFF] Signal inactive	[Yellow] 10G Port0 Link speed at maximum
D42	10G Port1 LinkSpd#	[OFF] Signal inactive	[Yellow] 10G Port0 Link speed indication
D41	10G Port2 ACT#	[OFF] Signal inactive	[Yellow] 10G Port0 Activity
D40	10G Port2 LinkSpdMax#	[OFF] Signal inactive	[Yellow] 10G Port0 Link speed at maximum
D39	10G Port2 LinkSpd#	[OFF] Signal inactive	[Yellow] 10G Port0 Link speed indication
D38	10G Port3 ACT#	[OFF] Signal inactive	[Yellow] 10G Port0 Activity
D37	10G Port3 LinkSpdMax#	[OFF] Signal inactive	[Yellow] 10G Port0 Link speed at maximum

Reference designator	Indicator	Color A	Color B
D36	10G Port3 LinkSpd#	[OFF] Signal inactive	[Yellow] 10G Port0 Linkspeed indication

8.4. Jumper (J27, J28, J29, J30)

Figure 21: Jumper 27 to 30

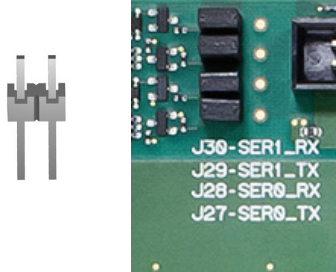

Table 25: Jumper 27 to 30

Jumper Position (Default)	Function description
J27 (closed)	SER0_TX
J28 (closed)	SER0_RX
J29 (closed)	SER1_TX
J30 (closed)	SER1_RX

8.5. Jumper (J49, J50, J57, J58, J59, J60)

Figure 22: Jumper J49, J50, J57, J58, J59, J60

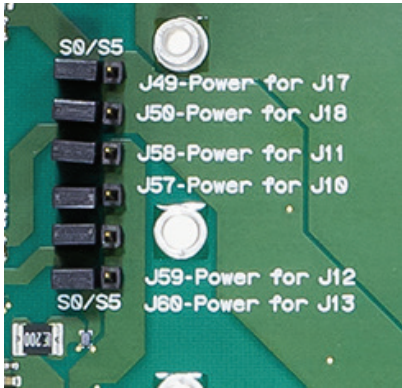

Table 26: Jumper J49, J50, J57, J58, J59, J60

Jumper Position (Default)	Function description
J49 (open)	Power for J17
J50 (open)	Power for J18
J57 (open)	Power for J10
J58 (open)	Power for J11

Jumper Position (Default)	Function description
J59 (open)	Power for J12
J60 (open)	Power for J13

8.6. Jumper (J36, J37, J42, J43, J46)

Figure 23: Jumper J36, J37, J42, J43, J46



Table 27: Jumper J36, J37, J42, J43, J46

Jumper Position (Default)	Function description
J36 (open)	LED_PWR
J37 (open)	BIOS_DIS0
J42 (open)	BIOS_DIS1
J43 (open)	USB_HOST
J46 (open)	TPM_PP

8.7. Jumper (J22-23, J24-25, J31, J35)

Figure 24: Jumper J22-23, J24-25, J31, J35

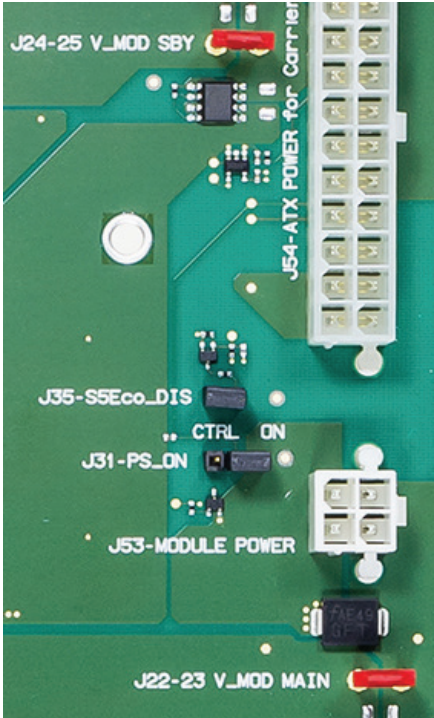

Table 28: Jumper J22-23, J24-25, J31, J35

Jumper Position (Default)	Function description
J22-23 (closed)	V_MOD MAIN
J24-25 (closed)	V_MOD SBY
J31 (open)	PS_ON
J35 (closed)	S5Eco_DIS

8.8. Jumper (J26, J34)

Figure 25: Jumper J26, J34

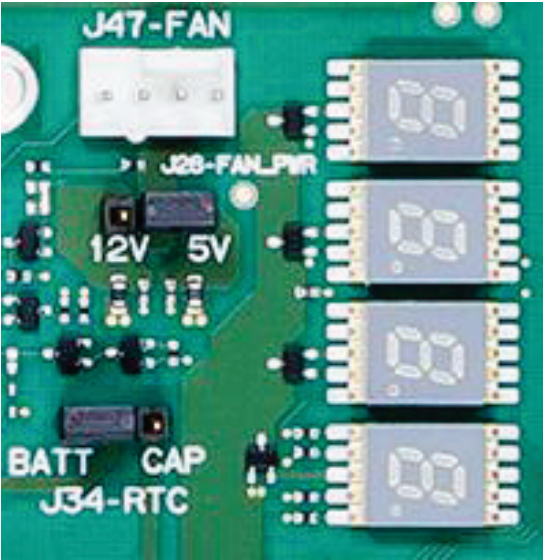

Table 29: Jumper J26, J34

Jumper Position (Default)	Function description
J26 (open)	FAN_PWR 5 V (Default) or 12 V
J34 (open)	RTC BATT (Default) or CAP

8.9. Button Switches

Figure 26: Button Switches, see board position 14

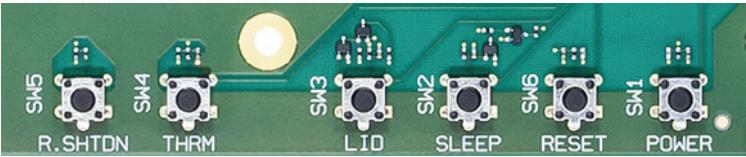
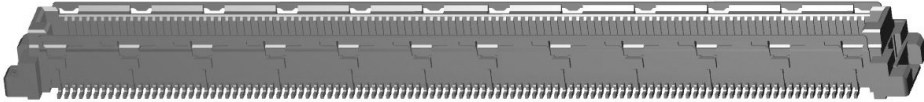

Table 30: LEDs

Button Switch	Function
SW1	POWER
SW2	SLEEP
SW3	LID (Lid)
SW4	THRM (Thermal)
SW5	R.SHTON (Rapid Shutdown)
SW6	RESET

9/ COMe Connector Pin-out List

Figure 27: COMe Connector with 220 pins



This table lists the pins and signals according to the PICMG specification COM.0 Rev 3.0 Type 7 standard.

Figure 28: COMe Connector Pinout

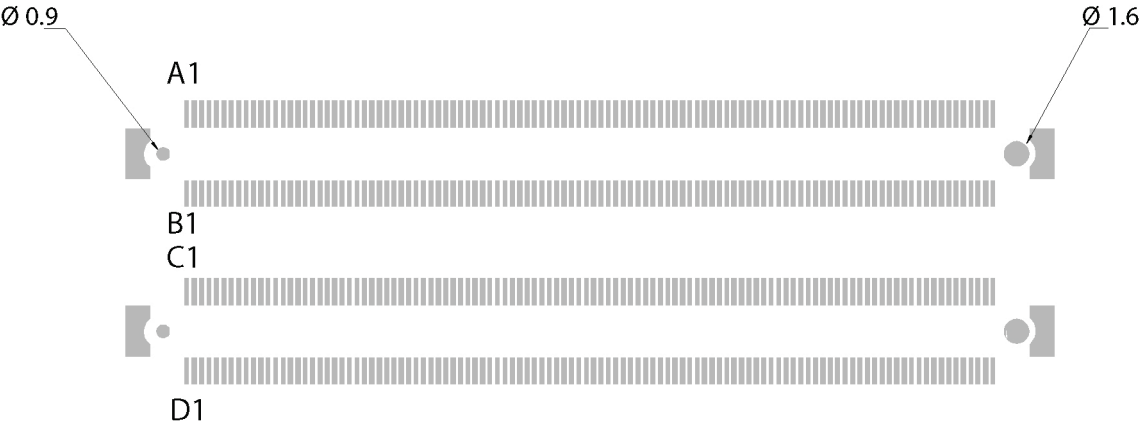

NOTICE

To protect external power lines of peripheral devices, make sure that: the wires have the right diameter to withstand the maximum available current the enclosure of the peripheral device fulfills the fire-protection requirements of IEC/EN60950.

Table 31: Pin-out List

Pin	Row A	Row B	Row C	Row D
1	GND(FIXED)	GND(FIXED)	GND(FIXED)	GND(FIXED)
2	GBE0_MDI3-	GBE0_ACT#	GND	GND
3	GBE0_MDI3+	LPC_FRAME#/ESPI_CS0#	USB_SSRX0-	USB_SSTX0-
4	GBE0_LINK100#	LPC_AD0/ESPI_O_0	USB_SSRX0+	USB_SSTX0+
5	GBE0_LINK1000#	LPC_AD1/ESPI_IO_1	GND	GND
6	GBE0_MDI2-	LPC_AD2/ESPI_O_2	USB_SSRX1-	USB_SSTX1-
7	GBE0_MDI2+	LPC_AD3/ESPI_O_3	USB_SSRX1+	USB_SSTX1+

Pin	Row A	Row B	Row C	Row D
8	GBE0_LINK#	LPC_DRQ0#/ESPI_ALERT0#	GND	GND
9	GBE0_MDI1-	LPC_DRQ1#/ESPI_ALERT1#	USB_SSRX2-	USB_SSTX2-
10	GBE0_MDI1+	LPC_CLK/ESPI_CLK	USB_SSRX2+	USB_SSTX2+
11	GND(FIXED)	GND(FIXED)	GND(FIXED)	GND(FIXED)
12	GBE0_MDI0-	PWRBTN#	USB_SSRX3-	USB_SSTX3-
13	GBE0_MDI0+	SMB_CK	USB_SSRX3+	USB_SSTX3+
14	GBE0_CTREF	SMB_DAT	GND	GND
15	SUS_S3#	SMB_ALERT#	10G_PHY_MDC_SCL3	10G_PHY_MDIO_SDA3
16	SATA0_TX+	SATA1_TX+	10G_PHY_MDC_SCL2	10G_PHY_MDIO_SDA2
17	SATA0_TX-	SATA1_TX-	10G_SDP2	10G_SDP3
18	SUS_S4#	SUS_STAT#/ESPI_RESET#	GND	GND
19	SATA0_RX+	SATA1_RX+	PCIE_RX6+	PCIE_TX6+
20	SATA0_RX-	SATA1_RX-	PCIE_RX6-	PCIE_TX6-
21	GND(FIXED)	GND(FIXED)	GND(FIXED)	GND(FIXED)
22	PCIE_TX15+	PCIE_RX15+	PCIE_RX7+	PCIE_TX7+
23	PCIE_TX15-	PCIE_RX15-	PCIE_RX7-	PCIE_TX7-
24	SUS_S5#	PWR_OK	10G_INT2	10G_INT3
25	PCIE_TX14+	PCIE_RX14+	GND	GND
26	PCIE_TX14-	PCIE_RX14-	10G_KR_RX3+	10G_KR_TX3+
27	BATLOW#	WDT	10G_KR_RX3-	10G_KR_TX3-
28	(S)ATA_ACT#	RSVD	GND	GND
29	RSVD	RSVD	10G_KR_RX2+	10G_KR_TX2+
30	RSVD	RSVD	10G_KR_RX2-	10G_KR_TX2-
31	GND(FIXED)	GND(FIXED)	GND(FIXED)	GND(FIXED)
32	RSVD	SPKR	10G_SFP_SDA3	10G_SFP_SCL3
33	RSVD	I2C_CK	10G_SFP_SDA2	10G_SFP_SCL2
34	BIOS_DIS0#/ESPI_SAFS	I2C_DAT	10G_PHY_RST_23	10G_PHY_CAP_23
35	THRMTRIP#	THRM#	10G_PHY_RST_01	10G_PHY_CAP_01
36	PCIE_TX13+	PCIE_RX13+	10G_LED_SDA	RSVD
37	PCIE_TX13-	PCIE_RX13-	10G_LED_SCL	RSVD

Pin	Row A	Row B	Row C	Row D
38	GND	GND	10G_SFP_SDA1	10G_SFP_SCL1
39	PCIE_TX12+	PCIE_RX12+	10G_SFP_SDA0	10G_SFP_SCL0
40	PCIE_TX12-	PCIE_RX12-	10G_SDP0	10G_SDP1
41	GND(FIXED)	GND(FIXED)	GND(FIXED)	GND(FIXED)
42	USB2-	USB3-	10G_KR_RX1+	10G_KR_TX1+
43	USB2+	USB3+	10G_KR_RX1-	10G_KR_TX1-
44	USB_2_3_OC#	USB_0_1_OC#	GND	GND
45	USB0-	USB1-	10G_PHY_MDC_SCL1	10G_PHY_MDIO_SDA1
46	USB0+	USB1+	10G_PHY_MDC_SCL0	10G_PHY_MDIO_SDA0
47	VCC_RTC	ESPI_EN#	10G_INT0	10G_INT1
48	RSVD	USB0_HOST_PRESENT	GND	GND
49	GBE0_SDP	SYS_RESET#	10G_KR_RX0+	10G_KR_TX0+
50	LPC_SERIRQ/ESPI_CS1#	CB_RESET#	10G_KR_RX0-	10G_KR_TX0-
51	GND(FIXED)	GND(FIXED)	GND(FIXED)	GND(FIXED)
52	PCIE_TX5+	PCIE_RX5+	PCIE_RX16+	PCIE_TX16+
53	PCIE_TX5-	PCIE_RX5-	PCIE_RX16-	PCIE_TX16-
54	GPIO	GPO1	TYPE0#	RSVD
55	PCIE_TX4+	PCIE_RX4+	PCIE_RX17+	PCIE_TX17+
56	PCIE_TX4-	PCIE_RX4-	PCIE_RX17-	PCIE_TX17-
57	GND	GPO2	TYPE1#	TYPE2#
58	PCIE_TX3+	PCIE_RX3+	PCIE_RX18+	PCIE_TX18+
59	PCIE_TX3-	PCIE_RX3-	PCIE_RX18-	PCIE_TX18-
60	GND(FIXED)	GND(FIXED)	GND(FIXED)	GND(FIXED)
61	PCIE_TX2+	PCIE_RX2+	PCIE_RX19+	PCIE_TX19+
62	PCIE_TX2-	PCIE_RX2-	PCIE_RX19-	PCIE_TX19-
63	GPI1	GPO3	RSVD	RSVD
64	PCIE_TX1+	PCIE_RX1+	RSVD	RSVD
65	PCIE_TX1-	PCIE_RX1-	PCIE_RX20+	PCIE_TX20+
66	GND	WAKE0#	PCIE_RX20-	PCIE_TX20-
67	GPI2	WAKE1#	RAPID_SHUTDOWN	GND
68	PCIE_TX0+	PCIE_RX0+	PCIE_RX21+	PCIE_TX21+

Pin	Row A	Row B	Row C	Row D
69	PCIE_TX0-	PCIE_RX0-	PCIE_RX21-	PCIE_TX21-
70	GND(FIXED)	GND(FIXED)	GND(FIXED)	GND(FIXED)
71	PCIE_TX8+	PCIE_RX8+	PCIE_RX22+	PCIE_TX22+
72	PCIE_TX8-	PCIE_RX8-	PCIE_RX22-	PCIE_TX22-
73	GND	GND	GND	GND
74	PCIE_TX9+	PCIE_RX9+	PCIE_RX23+	PCIE_TX23+
75	PCIE_TX9-	PCIE_RX9-	PCIE_RX23-	PCIE_TX23-
76	GND	GND	GND	GND
77	PCIE_TX10+	PCIE_RX10+	RSVD	RSVD
78	PCIE_TX10-	PCIE_RX10-	PCIE_RX24+	PCIE_TX24+
79	GND	GND	PCIE_RX24-	PCIE_TX24-
80	GND(FIXED)	GND(FIXED)	GND(FIXED)	GND(FIXED)
81	PCIE_TX11+	PCIE_RX11+	PCIE_RX25+	PCIE_TX25+
82	PCIE_TX11-	PCIE_RX11-	PCIE_RX25-	PCIE_TX25-
83	GND	GND	RSVD	RSVD
84	NCSI_TX_EN	VCC_5V_SBY	GND	GND
85	GPIO	VCC_5V_SBY	PCIE_RX26+	PCIE_TX26+
86	RSVD	VCC_5V_SBY	PCIE_RX26-	PCIE_TX26-
87	RSVD	VCC_5V_SBY	GND	GND
88	PCIE_CK_REF+	BIOS_DIS1#	PCIE_RX27+	PCIE_TX27+
89	PCIE_CK_REF-	NCSI_RX_ER	PCIE_RX27-	PCIE_TX27-
90	GND(FIXED)	GND(FIXED)	GND(FIXED)	GND(FIXED)
91	SPI_POWER	NCSI_CLK_IN	PCIE_RX28+	PCIE_TX28+
92	SPI_MISO	NCSI_RXD1	PCIE_RX28-	PCIE_TX28-
93	GPO0	NCSI_RXD0	GND	GND
94	SPI_CLK	NCSI_CRS_DV	PCIE_RX29+	PCIE_TX29+
95	SPI_MOSI	NCSI_TXD1	PCIE_RX29-	PCIE_TX29-
96	TPM_PP	NCSI_TXD0	GND	GND
97	TYPE10#	SPI_CS#	RSVD	RSVD
98	SER0_TX	NCSI_ARB_IN	PCIE_RX30+	PCIE_TX30+
99	SER0_RX	NCSI_ARB_OUT	PCIE_RX30-	PCIE_TX30-
100	GND(FIXED)	GND(FIXED)	GND(FIXED)	GND(FIXED)
101	SER1_TX	FAN_PWMOUT	PCIE_RX31+	PCIE_TX31+

Pin	Row A	Row B	Row C	Row D
102	SER1_RX	FAN_TACHIN	PCIE_RX31-	PCIE_TX31-
103	LID#	SLEEP#	GND	GND
104	VCC_12V	VCC_12V	VCC_12V	VCC_12V
105	VCC_12V	VCC_12V	VCC_12V	VCC_12V
106	VCC_12V	VCC_12V	VCC_12V	VCC_12V
107	VCC_12V	VCC_12V	VCC_12V	VCC_12V
108	VCC_12V	VCC_12V	VCC_12V	VCC_12V
109	VCC_12V	VCC_12V	VCC_12V	VCC_12V
110	GND(FIXED)	GND(FIXED)	GND(FIXED)	GND(FIXED)

10/ Technical Support

For technical support contact our Support department:

E-mail: support@kontron.com

Phone: +49-821-4086-888

Make sure you have the following information available when you call:

Product ID Number (PN),

Serial Number (SN)



The serial number can be found on the Type Label, located on the product's rear side.

Be ready to explain the nature of your problem to the service technician.

10.1. Warranty

Due to their limited service life, parts that by their nature are subject to a particularly high degree of wear (wearing parts) are excluded from the warranty beyond that provided by law. This applies to the CMOS battery, for example.



If there is a protection label on your product, then the warranty is lost if the product is opened.

10.2. Returning Defective Merchandise

All equipment returned to Kontron must have a Return of Material Authorization (RMA) number assigned exclusively by Kontron. Kontron cannot be held responsible for any loss or damage caused to the equipment received without an RMA number. The buyer accepts responsibility for all freight charges for the return of goods to Kontron's designated facility. Kontron will pay the return freight charges back to the buyer's location in the event that the equipment is repaired or replaced within the stipulated warranty period. Follow these steps before returning any product to Kontron.

1. Visit the RMA Information website:
<http://www.kontron.com/support-and-services/support/rma-information>

Download the RMA Request sheet for **Kontron Europe GmbH** and fill out the form. Take care to include a short detailed description of the observed problem or failure and to include the product identification Information (Name of product, Product number and Serial number). If a delivery includes more than one product, fill out the above information in the RMA Request form for each product.

2. Send the completed RMA-Request form to the fax or email address given below at Kontron Europe GmbH. Kontron will provide an RMA-Number.

Kontron Europe GmbH
RMA Support
Phone: +49 (0) 821 4086-0

Fax: +49 (0) 821 4086 111
Email: service@kontron.com

3. The goods for repair must be packed properly for shipping, considering shock and ESD protection.



Goods returned to Kontron Europe GmbH in non-proper packaging will be considered as customer caused faults and cannot be accepted as warranty repairs.

4. Include the RMA-Number with the shipping paperwork and send the product to the delivery address provided in the RMA form or received from Kontron RMA Support.

List of Acronyms

ACPI	Advanced Configuration & Power Interface
COMe	COM Express® - Computer on Module Express
EMC	ElectroMagnetic Compatibility
JIDA	JUMPTec Intelligent Device Architecture. Standard. JIDA is essentially an EEPROM, a data structure for the EEPROM, and a software definition.
ME	Management Engine
NC-SI	Network controller sideband interface
PCIe	PCI-Express
PICMG	PCI Industrial Computer Manufacturers Group
POR	Power-On Reset
PSU	Power Supply Unit
RTC	Real Time Clock
S0	ACPI OS System State 0. Indicates fully on operating state.
S3	ACPI OS System State 3. Indicates Suspend to RAM.
S5	ACPI OS System State 5. Indicates Soft Off operating state.
SIO	Super I/O
SSD	Solid-State Drive
SMB	System Management Bus.
SMBIOS	System Management BIOS
SMI	System Management Interrupt
SPD	Serial Presence Detect: A standardized way to automatically access information about a computer memory module.
WEEE	Waste Electrical and Electronic Equipment



About Kontron – Member of the S&T Group

Kontron is a global leader in Embedded Computing Technology (ECT). As a part of technology group S&T, Kontron offers a combined portfolio of secure hardware, middleware and services for Internet of Things (IoT) and Industry 4.0 applications. With its standard products and tailor-made solutions based on highly reliable state-of-the-art embedded technologies, Kontron provides secure and innovative applications for a variety of industries. As a result, customers benefit from accelerated time-to-market, reduced total cost of ownership, product longevity and the best fully integrated applications overall.

For more information, please visit: <http://www.kontron.com/>



GLOBAL HEADQUARTERS

Kontron Europe GmbH
Gutenbergstraße 2
85737 Ismaning
Germany
Tel.: + 49 821 4086-0
Fax: + 49 821 4086-111
info@kontron.com