



# FlatView, FlatView STS and FlatView RCK

Doc. User Guide, Rev. 2.7

Doc. ID: 1061-6343

This page has been intentionally left blank

 FLATVIEW - USER GUIDE

## Disclaimer

Kontron would like to point out that the information contained in this user guide may be subject to alteration, particularly as a result of the constant upgrading of Kontron products. This document does not entail any guarantee on the part of Kontron with respect to technical processes described in the user guide or any product characteristics set out in the user guide. Kontron assumes no responsibility or liability for the use of the described product(s), conveys no license or title under any patent, copyright or mask work rights to these products and makes no representations or warranties that these products are free from patent, copyright or mask work right infringement unless otherwise specified. Applications that are described in this user guide are for illustration purposes only. Kontron makes no representation or warranty that such applications will be suitable for the specified use without further testing or modification. Kontron expressly informs the user that this user guide only contains a general description of processes and instructions which may not be applicable in every individual case. In cases of doubt, please contact Kontron.

This user guide is protected by copyright. All rights are reserved by Kontron. No part of this document may be reproduced, transmitted, transcribed, stored in a retrieval system, or translated into any language or computer language, in any form or by any means (electronic, mechanical, photocopying, recording, or otherwise), without the express written permission of Kontron. Kontron points out that the information contained in this user guide is constantly being updated in line with the technical alterations and improvements made by Kontron to the products and thus this user guide only reflects the technical status of the products by Kontron at the time of publishing.

Brand and product names are trademarks or registered trademarks of their respective owners.

©2019 by Kontron Europe GmbH

Kontron Europe GmbH

Gutenbergstraße 2  
85373 Ismaning  
Germany  
[www.kontron.com](http://www.kontron.com)

## Intended Use

THIS DEVICE AND ASSOCIATED SOFTWARE ARE NOT DESIGNED, MANUFACTURED OR INTENDED FOR USE OR RESALE FOR THE OPERATION OF NUCLEAR FACILITIES, THE NAVIGATION, CONTROL OR COMMUNICATION SYSTEMS FOR AIRCRAFT OR OTHER TRANSPORTATION, AIR TRAFFIC CONTROL, LIFE SUPPORT OR LIFE SUSTAINING APPLICATIONS, WEAPONS SYSTEMS, OR ANY OTHER APPLICATION IN A HAZARDOUS ENVIRONMENT, OR REQUIRING FAIL-SAFE PERFORMANCE, OR IN WHICH THE FAILURE OF PRODUCTS COULD LEAD DIRECTLY TO DEATH, PERSONAL INJURY, OR SEVERE PHYSICAL OR ENVIRONMENTAL DAMAGE (COLLECTIVELY, "HIGH RISK APPLICATIONS").

You understand and agree that your use of Kontron devices as a component in High Risk Applications is entirely at your risk. To minimize the risks associated with your products and applications, you should provide adequate design and operating safeguards. You are solely responsible for compliance with all legal, regulatory, safety, and security related requirements concerning your products. You are responsible to ensure that your systems (and any Kontron hardware or software components incorporated in your systems) meet all applicable requirements. Unless otherwise stated in the product documentation, the Kontron device is not provided with error-tolerance capabilities and cannot therefore be deemed as being engineered, manufactured or setup to be compliant for implementation or for resale as device in High Risk Applications. All application and safety related information in this document (including application descriptions, suggested safety measures, suggested Kontron products, and other materials) is provided for reference only.

---

**NOTICE**

You find the most recent version of the "General Safety Instructions" online in the download area of this product.

---

---

**NOTICE**

This product is not suited for storage or operation in corrosive environments, in particular under exposure to sulfur and chlorine and their compounds. For information on how to harden electronics and mechanics against these stress conditions, contact Kontron Support.

---

## Revision History

Revision	Brief Description of Changes	Date of Issue	Author
1.6	Converted to the Kontron user guide style	2017-July-18	CW
1.7	Added 10.1", 12.1", 13.3" variants	2019-March-21	hjs
1.8	Exchanged Table 2 & 3 figures, updated RMA and Warranty	2019-July-16	CW
1.9	Added refresh rate information in Table 5	2019-Dec-03	CW
2.0	Added new dimension diagrams (15.6" slim/18.5" slim and 21.6" slim), OSD sub menu Scan Inputs information, and in Technical Specification table included Power Consumption, Input Current and Input Voltage range. Updated Type Label, General Safety Instructions for Equipment, Order Information and Certification Info. Removed display size 13.3".	2020-July-20	CW
2.1	Updated the Chapter 6: Order Information and Chapter 8: Installation information.	2020-Oct-01	CW
2.2	Added direct sunlight warning and "RCK" 19" rackmount product variant	2020-Nov-24	CW
2.3	Updated the General Safety Instructions and company address	2020-Dec-21	CW
2.4	Add the FlatView STS and updated the OSD	2021-Feb-18	CW
2.5	Updated Installation instruction, battery and PSU cautions	2021-Aug-09	CW
2.6	Updated figure in Chapter 7.10.1	2022-May-12	hjs
2.7	Updated Chapter 8.4 Startup Procedure, 15.0" Brightness in Table 4 and added Chapter 6.3 Power Specification.	2022-Aug-12	CW

## Terms and Conditions

Kontron warrants products in accordance with defined regional warranty periods. For more information about warranty compliance and conformity, and the warranty period in your region, visit <http://www.kontron.com/terms-and-conditions>.

Kontron sells products worldwide and declares regional General Terms & Conditions of Sale, and Purchase Order Terms & Conditions. Visit <http://www.kontron.com/terms-and-conditions>.

For contact information, refer to the corporate offices contact information on the last page of this user guide or visit our website [CONTACT US](#).

## Customer Support

Find Kontron contacts by visiting <https://www.kontron.com/support-and-services>.

## Customer Service

As a trusted technology innovator and global solutions provider, Kontron extends its embedded market strengths into a services portfolio allowing companies to break the barriers of traditional product lifecycles. Proven product expertise coupled with collaborative and highly-experienced support enables Kontron to provide exceptional peace of mind to build and maintain successful products.

For more details on Kontron's service offerings such as: enhanced repair services, extended warranty, Kontron training academy, and more visit <https://www.kontron.com/support-and-services>.

## Customer Comments

If you have any difficulties using this user guide, discover an error, or just want to provide some feedback, contact [Kontron support](#). Detail any errors you find. We will correct the errors or problems as soon as possible and post the revised user guide on our website.

## Symbols

The following symbols may be used in this user guide

### **⚠ DANGER**

DANGER indicates a hazardous situation which, if not avoided, will result in death or serious injury.

### **⚠ WARNING**

WARNING indicates a hazardous situation which, if not avoided, could result in death or serious injury.

### **NOTICE**

NOTICE indicates a property damage message.

### **⚠ CAUTION**

CAUTION indicates a hazardous situation which, if not avoided, may result in minor or moderate injury.



Electric Shock!

This symbol and title warn of hazards due to electrical shocks (> 60 V) when touching products or parts of products. Failure to observe the precautions indicated and/or prescribed by the law may endanger your life/health and/or result in damage to your material.



ESD Sensitive Device!

This symbol and title inform that the electronic boards and their components are sensitive to static electricity. Care must therefore be taken during all handling operations and inspections of this product in order to ensure product integrity at all times.



HOT Surface!

Do NOT touch! Allow to cool before servicing.



Laser!

This symbol inform of the risk of exposure to laser beam and light emitting devices (LEDs) from an electrical device. Eye protection per manufacturer notice shall review before servicing.



This symbol indicates general information about the product and the user guide.

This symbol also indicates detailed information about the specific product configuration.



This symbol precedes helpful hints and tips for daily use.

## For Your Safety

Your new Kontron product was developed and tested carefully to provide all features necessary to ensure its compliance with electrical safety requirements. It was also designed for a long fault-free life. However, the life expectancy of your product can be drastically reduced by improper treatment during unpacking and installation. Therefore, in the interest of your own safety and of the correct operation of your new Kontron product, you are requested to conform with the following guidelines.

### High Voltage Safety Instructions

As a precaution and in case of danger, the power connector must be easily accessible. The power connector is the product's main disconnect device.

#### **⚠ CAUTION**

##### Warning

All operations on this product must be carried out by sufficiently skilled personnel only.

#### **⚠ CAUTION**



##### Electric Shock!

Before installing a non hot-swappable Kontron product into a system always ensure that your mains power is switched off. This also applies to the installation of piggybacks. Serious electrical shock hazards can exist during all installation, repair, and maintenance operations on this product. Therefore, always unplug the power cable and any other cables which provide external voltages before performing any work on this product.

Earth ground connection to vehicle's chassis or a central grounding point shall remain connected. The earth ground cable shall be the last cable to be disconnected or the first cable to be connected when performing installation or removal procedures on this product.

### Special Handling and Unpacking Instruction

#### **NOTICE**



##### ESD Sensitive Device!

Electronic products and their components are sensitive to static electricity. Therefore, care must be taken during all handling operations and inspections of this product, in order to ensure product integrity at all times.

#### **⚠ CAUTION**

Handling and operation of the product is permitted only for trained personnel within a work place that is access controlled. Follow the "General Safety Instructions" supplied with the product.

Do not handle this product out of the products protective enclosure while the product is not used for operational purposes unless it is otherwise protected.

Whenever possible, unpack or pack this product only at EOS/ESD safe work stations. Where a safe work station is not guaranteed, it is important for the user to be electrically discharged before touching the product with his/her hands or tools. This is most easily done by touching a metal part of your system housing.

It is particularly important to observe standard anti-static precautions when changing piggybacks, ROM devices, jumper settings etc. If the product contains batteries for RTC or memory backup, ensure that the product is not placed on conductive surfaces, including anti-static plastics or sponges. They can cause short circuits and damage the batteries or conductive circuits on the product.



## Lithium Battery Precautions

If your product is equipped with a lithium battery, take the following precautions when replacing the battery.

### ⚠ CAUTION

---

**Risk of Explosion if Battery is replaced by an incorrect Type. Dispose of used batteries According to the instructions.**

**Risque d'explosion si la batterie est remplacée par un type incorrect. Mettre au rebus les batteries usagées selon les instructions.**

---

## General Instructions on Usage

In order to maintain Kontron's product warranty, this product must not be altered or modified in any way. Changes or modifications to the product, that are not explicitly approved by Kontron and described in this user guide or received from Kontron Support as a special handling instruction, will void your warranty.

This product should only be installed in or connected to systems that fulfill all necessary technical and specific environmental requirements. This also applies to the operational temperature range of the specific board version that must not be exceeded. If batteries are present, their temperature restrictions must be taken into account.

In performing all necessary installation and application operations, only follow the instructions supplied by the present user guide.

Keep all the original packaging material for future storage or warranty shipments. If it is necessary to store or ship the product then re-pack it in the same manner as it was delivered.

Special care is necessary when handling or unpacking the product. See Special Handling and Unpacking Instruction.

## Quality and Environmental Management

Kontron aims to deliver reliable high-end products designed and built for quality, and aims to complying with environmental laws, regulations, and other environmentally oriented requirements. For more information regarding Kontron's quality and environmental responsibilities, visit <http://www.kontron.com/about-kontron/corporate-responsibility/quality-management>.

## Disposal and Recycling

Kontron's products are manufactured to satisfy environmental protection requirements where possible. Many of the components used are capable of being recycled. Final disposal of this product after its service life must be accomplished in accordance with the applicable country, state, or local laws or regulations.

## WEEE Compliance

The Waste Electrical and Electronic Equipment (WEEE) Directive aims to:

- ▶ Reduce waste arising from electrical and electronic equipment (EEE)
- ▶ Make producers of EEE responsible for the environmental impact of their products, especially when the product become waste
- ▶ Encourage separate collection and subsequent treatment, reuse, recovery, recycling and sound environmental disposal of EEE
- ▶ Improve the environmental performance of all those involved during the lifecycle of EEE



---

**Environmental protection is a high priority with Kontron.**

**Kontron follows the WEEE directive.**

**You are encouraged to return our products for proper disposal.**

---

# Table of Contents

Symbols .....	7
For Your Safety .....	8
High Voltage Safety Instructions .....	8
Special Handling and Unpacking Instruction .....	8
Lithium Battery Precautions .....	9
General Instructions on Usage .....	9
Quality and Environmental Management .....	9
Disposal and Recycling .....	9
WEEE Compliance .....	9
Table of Contents .....	10
List of Tables .....	12
List of Figures .....	12
1/ Introduction .....	13
2/ General Safety Instructions .....	14
2.1. Electromagnetic Compatibility EU .....	15
2.2. Electrostatic Discharge (ESD) .....	15
2.3. Grounding Methods .....	15
2.4. Instructions for Lithium Battery .....	16
3/ Scope of Delivery .....	17
3.1. Packaging .....	17
3.2. Unpacking .....	17
3.3. Scope of Delivery .....	17
3.4. Accessories .....	18
3.5. Type Label and Product Identification .....	19
4/ Product Features .....	20
4.1. FlatView (VESA) Features .....	20
4.2. FlatView (built-in)/FlatView STS Features .....	21
4.3. FlatView RCK Features .....	22
5/ Order Information .....	23
6/ Product Specification .....	24
6.1. Technical Specification .....	24
6.1.1. Refresh Rates DP, DVI Digital and DVI Analog .....	28
6.2. Environmental Specification .....	28
6.3. Power Specification .....	29
6.4. Compliance .....	29
7/ Mechanical Diagrams .....	31
7.1. 10.1" Mechanical Dimensions .....	31
7.1.1. 10.1" Monitor Built-in .....	31
7.2. 10.4" Mechanical Dimensions .....	32
7.2.1. 10.4" Monitor Built-in .....	32
7.2.2. 10.4" Monitor VESA .....	33
7.3. 12.1" Mechanical Dimensions .....	34
7.3.1. 12.1" Monitor Built-in (SVGA, XGA) .....	34
7.3.2. 12.1" Monitor VESA (SVGA, XGA) .....	35
7.3.3. 12.1" Monitor Built-in (WXGA) .....	36
7.3.4. 12.1" Monitor VESA (WXGA) .....	37

7.4. 15.0" Mechanical Dimensions .....	38
7.4.1. 15.0" Monitor Built-in.....	38
7.4.2. 15.0" Monitor VESA.....	39
7.5. 15.6" Mechanical Dimensions.....	40
7.5.1. 15.6" Monitor Built-in (slim).....	40
7.5.2. 15.6" Monitor VESA (slim) .....	41
7.5.3. 15.6" Built-in Variant.....	42
7.5.4. 15.6" Monitor VESA.....	43
7.6. 17.0" Mechanical Dimensions .....	44
7.6.1. 17.0" Monitor Built-in .....	44
7.6.2. 17.0" Monitor VESA.....	45
7.7. 18.5" Mechanical Dimensions .....	46
7.7.1. 18.5" Monitor Built-in (slim) .....	46
7.7.2. 18.5" Monitor VESA (slim).....	47
7.7.3. 18.5" Monitor Built-in (HD, Full HD).....	48
7.7.4. 18.5" Monitor VESA (HD, Full HD) .....	49
7.8. 19.0" Mechanical Dimensions .....	50
7.8.1. 19.0" Monitor Built-in.....	50
7.8.2. 19.0" Monitor VESA .....	51
7.8.3. 19" Monitor Rackmount.....	52
7.9. 21.5" Mechanical Dimensions .....	53
7.9.1. 21.5" Monitor Built-in (slim).....	53
7.9.2. 21.5" Monitor VESA (slim).....	54
7.9.3. 21.5" Monitor Built-in .....	55
7.9.4. 21.5" Monitor VESA.....	55
7.10. 23.8" Mechanical Dimensions.....	56
7.10.1. 23.8" Monitor Built-in .....	56
7.10.2. 23.8" Monitor VESA.....	56
<b>8/ Installation and Start .....</b>	<b>57</b>
8.1. Mounting Instructions Built-in .....	57
8.2. Mounting Instructions VESA.....	59
8.3. Mounting Instructions Rack.....	59
8.4. Startup Procedure.....	60
8.4.1. Connecting to a Power Supply .....	60
8.4.2. Wiring the Mating Power Connector.....	61
8.4.3. Switch On and Off.....	62
<b>9/ Connectors.....</b>	<b>63</b>
9.1. Input Power Connector (PWR).....	63
9.2. DVI Connector .....	64
9.3. Display Port (DP) Connector .....	64
9.4. USB Port (Type B).....	64
<b>10/ OSD (On Screen Display).....</b>	<b>65</b>
10.1. OSD Keypad .....	65
10.1.1. Power Button .....	65
10.1.2. Power LED .....	65
10.1.3. Menu Button.....	65
10.1.4. Select Button.....	66
10.1.5. Up and Down Button.....	67
10.2. OSD Menu.....	68

10.2.1. Main Menu: Input Select .....	68
10.2.2. Main Menu: Image Adjustments .....	69
10.2.3. Main Menu: Color Adjustment .....	72
10.2.4. Main Menu: VGA Settings .....	75
10.2.5. Main Menu: OSD Settings .....	78
10.2.6. Main Menu: System Settings.....	81
10.2.7. Main Menu: Info .....	82
<b>11/</b> Technical Support .....	<b>83</b>
11.1. Returning Defective Merchandise .....	83
<b>12/</b> Storage, Transportation and Maintenance.....	<b>84</b>
12.1. Storage.....	84
12.2. Transportation.....	84
12.3. Maintenance.....	84
12.4. Cleaning the Display .....	84
<b>13/</b> Warranty .....	<b>85</b>
Appendix: List of Acronyms .....	86
About Kontron .....	87

## List of Tables

Table 1: Electromagnetic Compatibility CE.....	15
Table 2: Scope of Delivery .....	17
Table 3: List of Accessories.....	18
Table 4: Technical Specification for Display sizes .....	24
Table 5: Refresh Rate: DP & DVI Digital and Refresh Rate: DVI Analog .....	28
Table 6: Environmental Specification .....	28
Table 7: Directives and Standards Compliance .....	29
Table 8: Input Power Connector Pinout .....	63
Table 9: DVI Connector Pinout.....	64
Table 10: DP Connector Pinout .....	64
Table 11: USB Port Pinout .....	64
Table 12: LED Power Indicator's Color Description.....	65
Table 13: List of Acronyms.....	86

## List of Figures

Figure 1: FlatView, FlatView STS and FlatView RCK(right).....	13
Figure 2: Type Label.....	19
Figure 3: Front Side – FlatView (VESA).....	20
Figure 4: Rear Panel – FlatView (VESA) .....	20
Figure 5: Front Side – FlatView (built-in)/FlatView STS .....	21
Figure 6: Rear Panel – FlatView (built-in)/FlatView STS .....	21
Figure 7: Front Side – FlatView RCK.....	22
Figure 8: Rear Panel – FlatView RCK.....	22
Figure 9: Mounting Set with Clamping Brackets and Screws .....	57
Figure 10: Clamping Bracket with Screw .....	58
Figure 11: Clamping Bracket Insertion.....	58
Figure 12: Fastening the Clamping Bracket.....	58
Figure 13: Clamping Bracket Positions .....	58
Figure 14: Mating Power Connector .....	61
Figure 15: FlatView Connector Panel.....	63
Figure 16: OSD Keys.....	65

## 1/ Introduction

This user guide provides an overview of the FlatView industrial grade monitor series referred to as FlatView in this user guide. This user guide is intended to help users set up, install, operate and maintain the FlatView properly. Kontron recommends new operators to study the instructions within this user guide before switching on the power.

With its FlatView Industrial Monitor series, Kontron offers high mechanical flexibility with respect to the design. It can be used both as a full-metal solution with VESA as well as a built-in solution. The built-in version is installed directly on the machine or in a command or control console. The FlatView is service-friendly for the user and is designed for a long life cycle thanks to carefully selected components from renowned manufacturers.

The FlatView industrial monitor series includes the FlatView STS stainless steel monitor built-in variant that installs directly on the machine or in a command or control console. For industrial applications, the FlatView RCK rack mount provides easy 19" industrial rack installation.

The FlatView is service-friendly for the user and is designed for a long life cycle thanks to carefully selected components from renowned manufacturers.

Figure 1: FlatView, FlatView STS and FlatView RCK(right)



## 2/ General Safety Instructions

Please read this passage carefully and take careful note of the instructions, which have been compiled for your safety and to ensure to apply in accordance with intended regulations. If the following general safety instructions are not observed, it could lead to injuries to the operator and/or damage of the product; in cases of non-observance of the instructions Kontron Europe is exempt from accident liability, this also applies during the warranty period.

The product has been built and tested according to the basic safety requirements for low voltage (LVD) applications and has left the manufacturer in safety-related, flawless condition. To maintain this condition and to also ensure safe operation, the operator must not only observe the correct operating conditions for the product but also the following general safety instructions:

- ▶ The product must be used as specified in the product documentation, in which the instructions for safety for the product and for the operator are described. These contain guidelines for setting up, installation and assembly, maintenance, transport or storage.
- ▶ The on-site electrical installation must meet the requirements of the country's specific local regulations.
- ▶ If a power cable comes with the product, only this cable should be used. Do not use an extension cable to connect the product.
- ▶ To guarantee that sufficient air circulation is available to cool the product, please ensure that the ventilation openings are not covered or blocked. If a filter mat is provided, this should be cleaned regularly. Do not place the product close to heat sources or damp places. Make sure the product is well ventilated.
- ▶ Only connect the product to an external power supply providing the voltage type (AC or DC) and the input power (max. current) specified on the Kontron Product Label and meeting the requirements of the Limited Power Source (LPS) and Power Source (PS2) of UL/IEC 62368-1.
- ▶ Only products or parts that meet the requirements for Power Source (PS1) of UL/IEC 62368-1 may be connected to the product's available interfaces (I/O).
- ▶ Before opening the product, make sure that the product is disconnected from the mains.
- ▶ Switching off the product by its power button does not disconnect it from the mains. Complete disconnection is only possible if the power cable is removed from the wall plug or from the product. Ensure that there is free and easy access to enable disconnection.
- ▶ The product may only be opened for the insertion or removal of add-on cards (depending on the configuration of the product). This may only be carried out by qualified operators.
- ▶ If extensions are being carried out, the following must be observed:
  - ▶ all effective legal regulations and all technical data are adhered to
  - ▶ the power consumption of any add-on card does not exceed the specified limitations
  - ▶ the current consumption of the product does not exceed the value stated on the product label
- ▶ Only original accessories that have been approved by Kontron Europe can be used.
- ▶ Please note: safe operation is no longer possible when any of the following applies:
  - ▶ the product has visible damages or
  - ▶ the product is no longer functioning
 In this case the product must be switched off and it must be ensured that the product can no longer be operated.
- ▶ Handling and operation of the product is permitted only for trained personnel within a work place that is access controlled.
- ▶ CAUTION: Risk of explosion if the battery is replaced incorrectly (short-circuited, reverse-poled, wrong battery type). Dispose of used batteries according to the manufacturer's instructions.
- ▶ This product is not suitable for use in locations where children are likely to be present

### Additional Safety Instructions for DC Power Supply Circuits

- ▶ To guarantee safe operation, please observe that:
  - ▶ the external DC power supply must meet the criteria for LPS and PS2 (UL/IEC 62368-1)
  - ▶ no cables or parts without insulation in electrical circuits with dangerous voltage or power should be touched directly or indirectly
  - ▶ a reliable protective earthing connection is provided

- ▶ a suitable, easily accessible disconnecting device is used in the application (e.g. overcurrent protective device), if the product itself is not disconnect able
- ▶ a disconnect device, if provided in or as part of the product, shall disconnect both poles simultaneously
- ▶ interconnecting power circuits of different products cause no electrical hazards
- ▶ A sufficient dimensioning of the power cable wires must be selected – according to the maximum electrical specifications on the product label – as stipulated by EN62368-1 or VDE0100 or EN60204 or UL61010-1 regulations.

For the General Safety Instruction in German or French, visit [Kontron's product web page> Downloads> Manuals> General Safety Instructions.](#)

## 2.1. Electromagnetic Compatibility EU

This product is in conformity with the protection requirements of EU Council Directive 2014/30/EU on the approximation of the laws of the Member States relating to electromagnetic compatibility. If the user modifies and/or adds to the equipment, the prerequisites for the CE conformity declaration, (safety requirements) may no longer apply. For further compliance information, see Chapter 5.3: Compliance.

**Table 1: Electromagnetic Compatibility CE**

EN 55032	Information technology equipment, Radio disturbance characteristics, Limits and methods of measurement (CISPR 32:2015)
EN 61000-6-2	Electromagnetic compatibility (EMC), Part 6-2:Generic Standards - Immunity for industrial environments+ CENELEC- Cor.:2005

## 2.2. Electrostatic Discharge (ESD)



---

**A sudden discharge of electrostatic electricity can destroy static-sensitive devices or micro-circuitry.**

---

Proper packaging and grounding techniques are necessary precautions to prevent damage. Always take the following general precautions:

1. Always be properly grounded when touching ESD sensitive product(s).
2. Always handle ESD sensitive product(s) by their casing.
3. Switch off power and input signals before inserting and removing connectors or connecting test equipment.

## 2.3. Grounding Methods

Proper grounding methods are necessary to avoid damage to the product. Always take the following general precautions:

1. Ensure the product is grounded before powering on the product.
2. Connect the product only to an applied ground that meets all applicable local, national and international grounding requirements.
3. When assembling, the first cable to be connected is the ground and when disassembling, the last cable to be removed is the ground cable.

### **⚠ CAUTION**

---

**The installation sites applied ground must meet any ground requirements specified in this user guide and those of your local, national and international region.**

---

## 2.4. Instructions for Lithium Battery

If the product is equipped with a lithium battery. When replacing the battery observe the instructions below.

### **CAUTION**

---

Risk of Explosion if Battery is replaced by an incorrect Type. Dispose of used batteries According to the instructions.

Risque d'explosion si la batterie est remplacée par un type incorrect. Mettre au rebus les batteries usagées selon les instructions.

---



---

Do not dispose of lithium batteries in general trash collection. Dispose of the battery according to the local regulations dealing with the disposal of these special materials, (e.g. to the collecting points for dispose of batteries).

---



## 3/ Scope of Delivery

### 3.1. Packaging

All parts are delivered together in a product specific cardboard package designed to provide adequate protection to absorb shock. Kontron recommends keeping the packaging to store or transport the FlatView.

### 3.2. Unpacking

To unpack the FlatView, perform the following:

1. Remove packaging.
2. Do not discard the original packaging. Keep the original packaging for future transportation or storage.
3. Check the delivery for completeness by comparing the delivery with the original order.
4. Keep the associated paperwork. It contains important information for handling the product.
5. Check the product for visible shipping damage.

If you notice any shipping damage or inconsistencies between the contents and the original order, contact your dealer.

### 3.3. Scope of Delivery

Check that your delivery is complete. If you discover damaged or missing items, contact your dealer.

Table 2: Scope of Delivery

	Qty.	Part Number	Part Description
FlatView	1	See Chapter 0  <b>FlatView is intended for indoor, outdoor, outdoor use. Observe that the following conditions apply:</b> <ul style="list-style-type: none"> <li>• Prolonged exposure to sunlight</li> <li>• Short exposure to direct sunlight may cause permanent color changes</li> <li>• Direct exposure to rain</li> </ul> <b>For intended use in outdoor environments, a representative.</b>	FlatView with ordered display size, screen touch technology, mounting variant (VESA, Built-in, rackmount) and display option (HD, Full HD, XGA etc.)
Mounting set	1	EM21-100168-01 (10.1") EM21-100065-0 (10.4"/12.1") EM21-100066-0 (15.0"/15.6") EM21-100067-01 (17.0"/19.0") EM21-100068-01 (18.5"/23.8") EM21-100069-01 (21.5")	Order Information.  This line item is only included with the built-in version.  The delivered mounting clamping brackets and screws part number depends on the display size.

### 3.4. Accessories

Table 3: List of Accessories

Part	Qty.	Part Number	Part Description
Phoenix Power Connector (mating)	1	EE04-100001-01	Phoenix Power Subcon w/ housing mating connector
Power Cable EU	1	840-0059	EU-Power cable , length 1,8m
AC/DC Power Supply (24 VDC) Kit	1	ER40-100001-01	Power supply 24 VDC and Phoenix mating connector kit
AC/DC Power Supply (24 VDC) Kit		ER40-100005-01	1x Power supply 24 VDC, 1x Phoenix mating connector and 1x EU-Power cable 1,8m kit
HDMI to DP Adapter cable	1	PR22-100004-01	HDMI to DisplayPort cable length 20 cm, 4K aktive, Delock: 62607
HDMI to DP 1.2 Adapter	1	PR22-100005-01	4K aktive, Delock: 65573
DVI-D to DP 1.1 Adapter	1	PR22-100006-01	Delock: 65257
VGA to DP 1.1 Adapter	1	PR22-100007-01	Delock: 65567
DVI-I (24+5) to HDMI Adapter	1	PR22-100008-01	Delock: 65467 with thumb screws
DP Cable 1.8 m	1	840-0758	DisplayPort cable: length 1.8m
DP Cable 3 m	1	840-0759	DisplayPort cable: length 3m
DP Cable 5 m	1	840-0760	DisplayPort cable: length 5m
VGA to DVI Adapter	1	840-0598	Adapter VGA / DVI
VGA/SVGA Cable 1.8 m to 2 m	1	840-0039	VGA/SVGA cable length 1,8m/2,0m
USB Type A / Type B Cable	1	840-0273	USB-cable Type A – Type B, length 1.8 m
DVI Cable	1	840-0134	DVI cable, length 2m

### 3.5. Type Label and Product Identification

The type label contains specific product identification information, the electrical specification and certification conformity on a polyester matt silver label, located on the rear panel of the FlatView.

Figure 2: Type Label

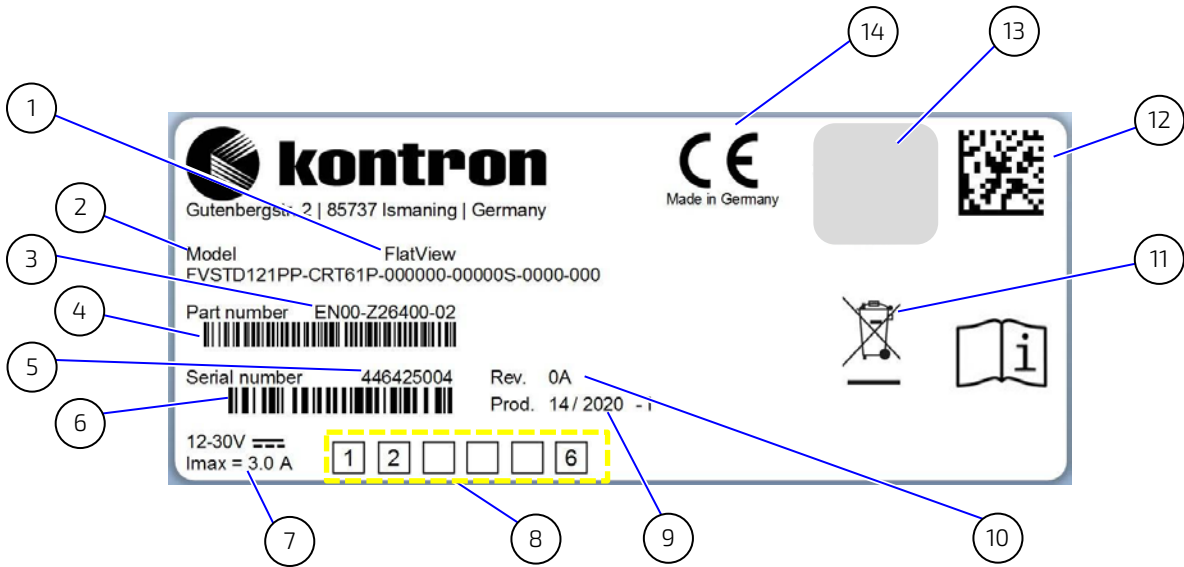

- |   |                          |    |                                      |
|---|--------------------------|----|--------------------------------------|
| 1 | Model name               | 8  | Internal use only                    |
| 2 | Model number             | 9  | Production date                      |
| 3 | Part number              | 10 | Revision                             |
| 4 | Barcode part number      | 11 | Disposal information                 |
| 5 | Serial number            | 12 | QR code                              |
| 6 | Barcode serial number    | 13 | Reserved area (for UL certification) |
| 7 | Electrical specification | 14 | Certification                        |

## 4/ Product Features

### 4.1. FlatView (VESA) Features

The FlatView (VESA) is a full-metal solution with VESA (75 mm/100mm patterns) enabling stand-alone installation.

Figure 3: Front Side – FlatView (VESA)

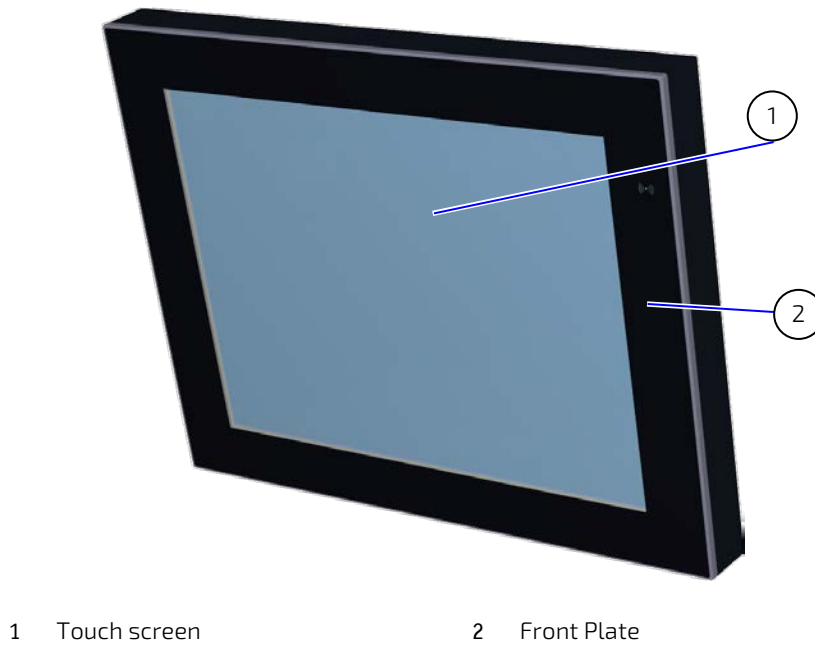

1 Touch screen

2 Front Plate

Figure 4: Rear Panel – FlatView (VESA)

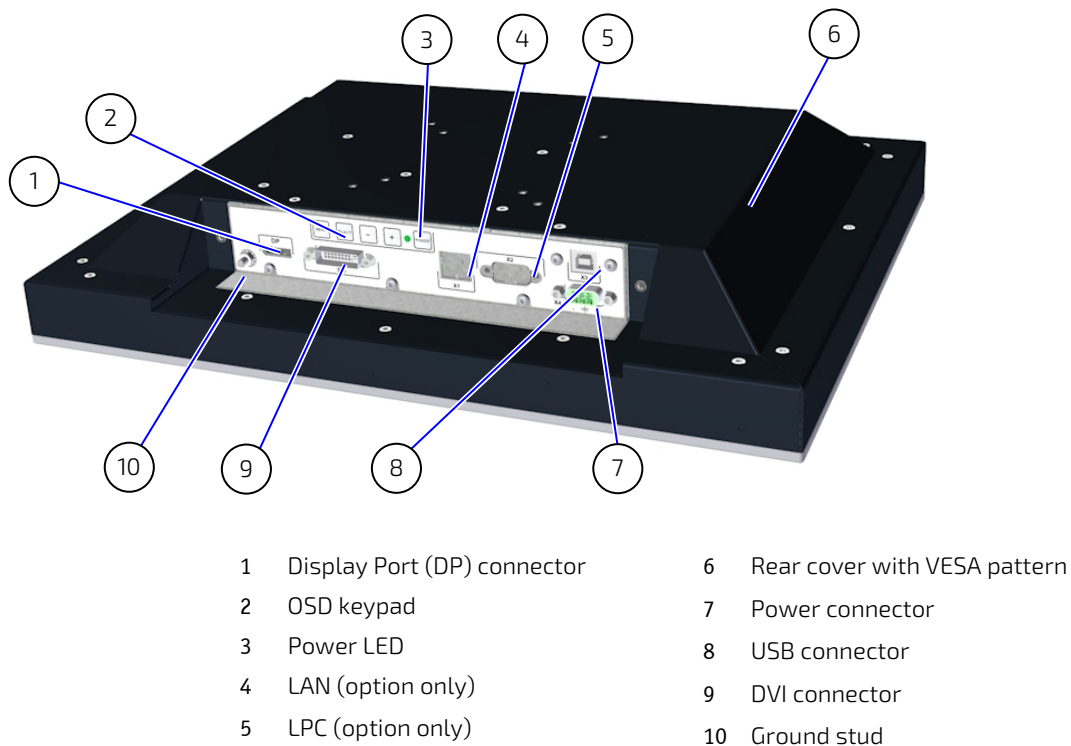

1 Display Port (DP) connector

2 OSD keypad

3 Power LED

4 LAN (option only)

5 LPC (option only)

6 Rear cover with VESA pattern

7 Power connector

8 USB connector

9 DVI connector

10 Ground stud

## 4.2. FlatView (built-in)/FlatView STS Features

The FlatView (built-in) and the FlatView STS stainless steel built-in variant both install directly on the machine or in a command or control console. The FlatView STS with front stainless steel frame and specially sealed front glass is idea for deployment in applications with high hygienic requirements.

Figure 5: Front Side – FlatView (built-in)/FlatView STS

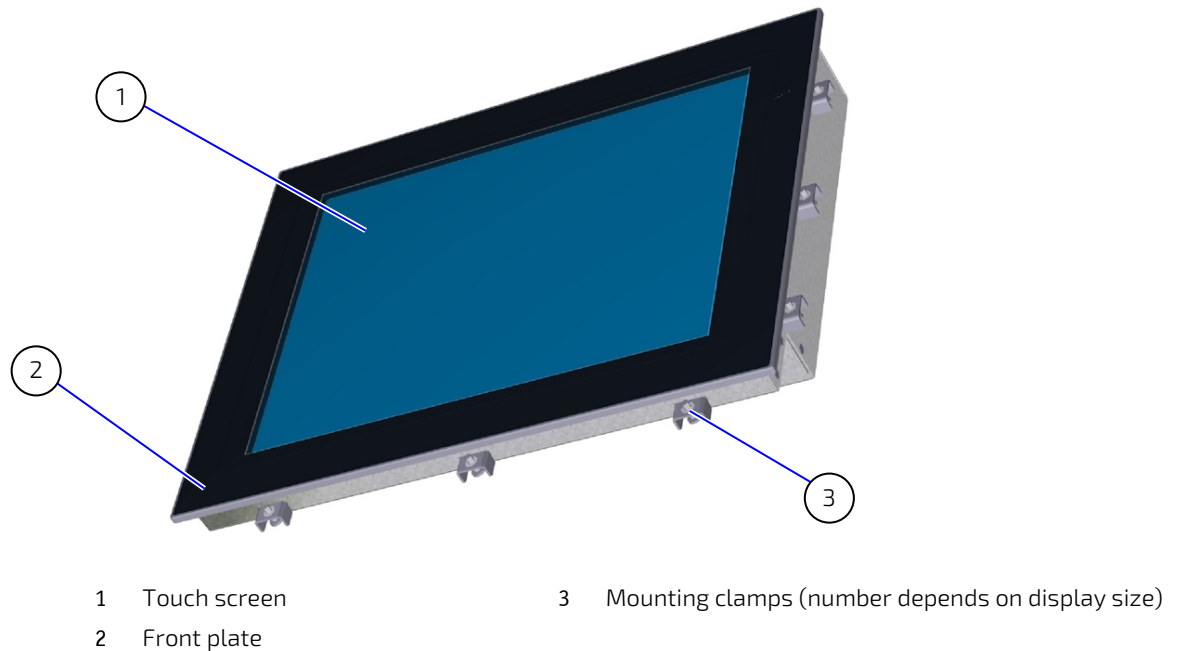
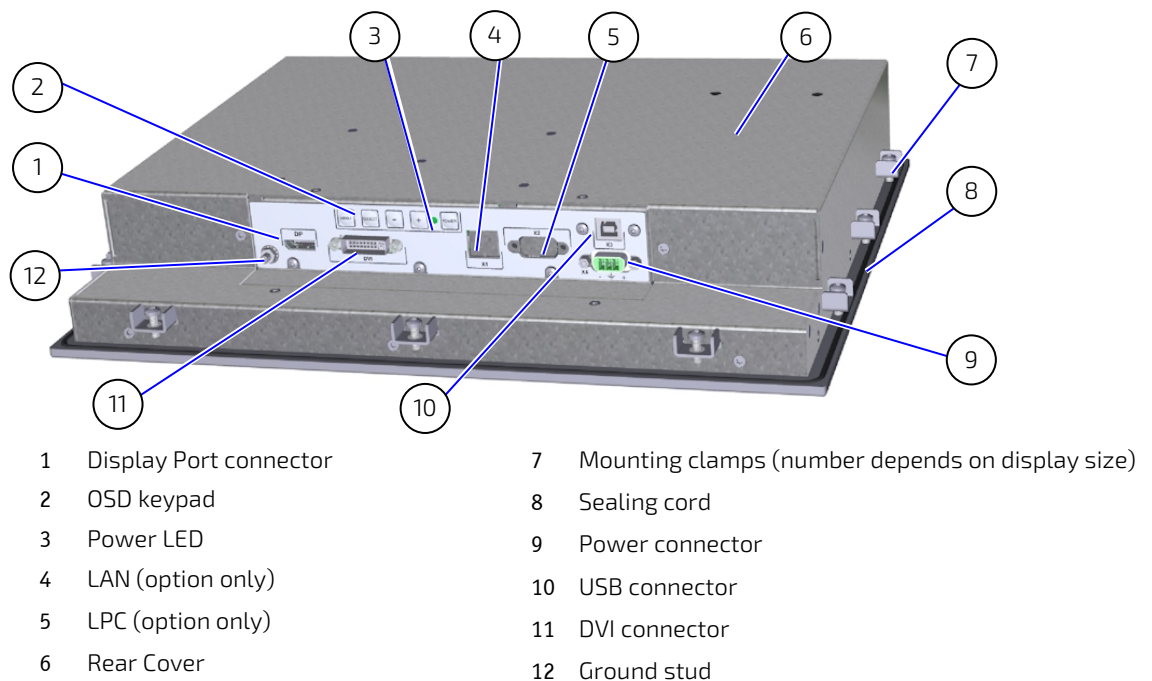

Figure 6: Rear Panel – FlatView (built-in)/FlatView STS



### 4.3. FlatView RCK Features

The FlatView RCK rack mount provides easy 19" industrial rack installation.

Figure 7: Front Side – FlatView RCK

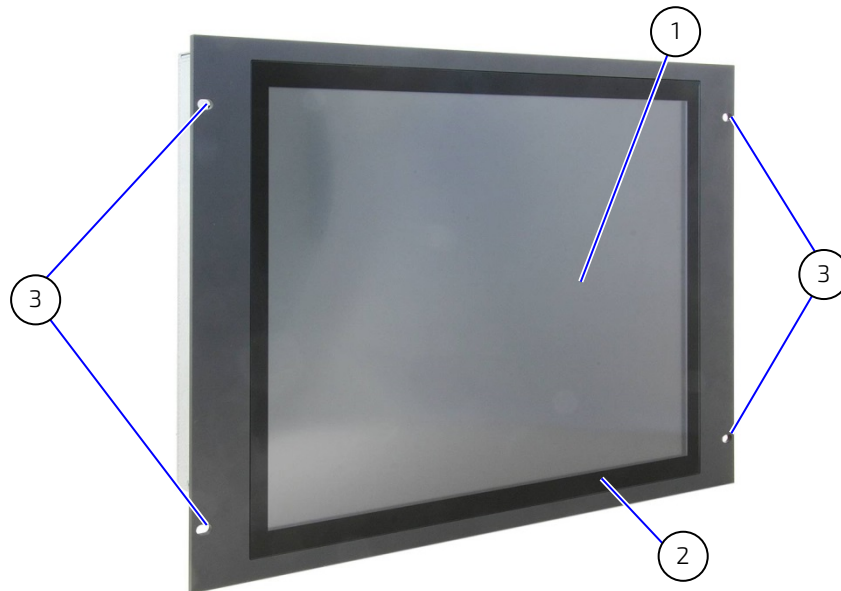

- |   |              |   |                                                  |
|---|--------------|---|--------------------------------------------------|
| 1 | Touch screen | 3 | 19" rack mounting frame with four mounting holes |
| 2 | Front plate  |   |                                                  |

Figure 8: Rear Panel – FlatView RCK

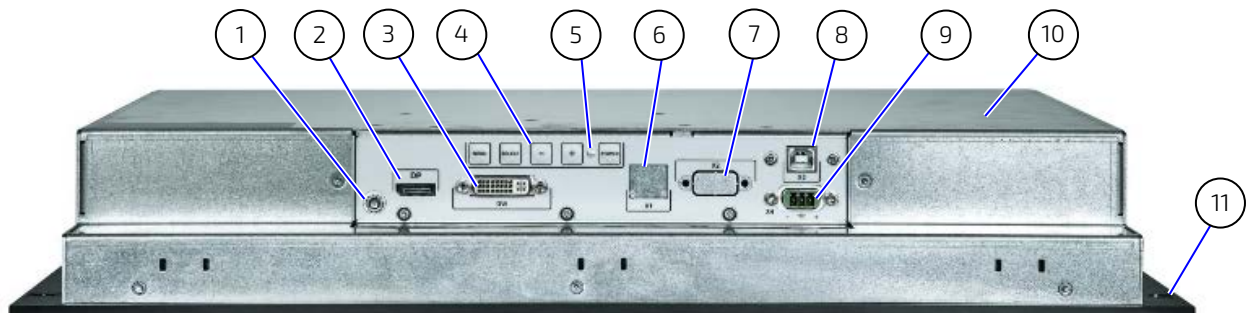

- |   |                             |    |                                          |
|---|-----------------------------|----|------------------------------------------|
| 1 | Ground stud                 | 7  | LPC (option only)                        |
| 2 | Display Port (DP) connector | 8  | USB connector                            |
| 3 | DVI connector               | 9  | Power connector<br>(Insert Power Supply) |
| 4 | OSD keypad                  | 10 | Rear cover                               |
| 5 | Power LED                   | 11 | 19" rack frame with 4 mounting holes     |
| 6 | LAN (option only)           |    |                                          |

## 5/ Order Information

Example of an order number **EN00-Z41300-01** = FlatView 15.6" with resistive touch and VESA mount.

### EN00-yyy-yy-xx

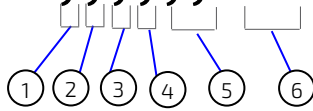

1. Product Family                    Z= FlatView
  
2. Display Size:                    1 = 10.4"  
                                           2 = 12.1"  
                                           3 = 15.0"  
                                           4 = 15.6"  
                                           5 = 17.0"  
                                           6 = 18.5"  
                                           7 = 19.0"  
                                           8 = 21.5"  
                                           H= 23.8"
  
3. Touch Technology:            0 = Without touch, only with protection glass  
                                           1 = Touch resistive  
                                           2 = Touch PCAP  
                                           3 = Protection glass  
                                           4 = Touch resistive  
                                           5 = Touch PCAP  
                                           6= Touch PCAP V2 (low cost)  
                                           7 = Protection glass V2 (low cost)  
                                           8= Slim with PCAP  
                                           9= Slim with protection glass  
                                           A= Slim with PCAP (V2)  
                                           B= Slim with Protection glass (V2)  
                                           C= With PMMA  
                                           D= With Touch PCAP PMMA
  
4. Mounting Variant:            3 = Monitor VESA  
                                           4 =Monitor Built-in  
                                           5= Monitor Rackmount (RCK)
  
5. Options:                        Possible Display option (Full HD, HD, XGA. W XGA)
  
6. Internal Code                    Revision

## 6/ Product Specification

### 6.1. Technical Specification

Table 4: Technical Specification for Display sizes

Display Size	10.1"	10.4"	12.1"	12.1"	12.1"
Resolution (pixels) [1]	1280x800	800x600, SVGA	800x600 SVGA	1024x768, XGA	1280x800, WXGA
Format	16:10	4:3	4:3	4:3	16:10
Contrast Ratio	800:1	700:1	1500:1	700:1	1000:1
Brightness	500cd	400 cd	450 cd	600 cd	500 cd
Angle View	H170°/V170°	H160°/V140°	H178°/V178°	H160°/V140°	H178°/V178°
Colors	16.2 million	16.7 million	16.7 million	16.2 million	16.7 million
LED Lifetime (> 50%, 25°C)	> 50,000 h	> 50,000 h	> 50,000 h	> 50,000 h	> 100,000 h
<b>Housing</b>					
Dimensions WxHxD (mm)	276 x 195 x 65	297 x 244 x 65	338 x 277 x 65	338 x 277 x 65	315 x 228 x 65
Weight	~ 3.7 kg	~ 3.9 kg	~ 4.7 kg	~ 4.7 kg	~ 4.7 kg
Protection glass	option	option	option	option	option
PCAP (Multi-touch)	option	option	option	option	option
Resistive touch	On request	option	option	option	On request
Color	RAL 7021 (black anthracite)				
Mounting	VESA 75/75 mm or 100/100 mm (full metal housing only) Clamping brackets (built-in-variant only) 19" rackmount (FlatView RCK with 19.0" display, other on request)				
Cooling	Fanless passive cooling				
Protection Class	Front: IP65, Housing IP20				
<b>Electrical Specification</b>					
Input Voltage (Range)	12 VDC to 30 VDC	12 VDC to 30 VDC	12 VDC to 30 VDC	12 VDC to 30 VDC	12 VDC to 30 VDC
Input Current (@ 12 V)	0.8 A	0.9 A	1.2 A	1.6 A	1.3 A
Power Consumption (max.)	10.4 W +-5%	12.1 W +- 5%	16.2 W +-5%	21 W +-5%	16.9 W +-5%
Power Supply	12 VDC -30 VDC Input via Phoenix Connector PSC 1,5/3-F				
<b>I/O</b>					
Video IN	1x DVI, 1x Display Port				
I/O Options	USB 2.0 (Type B) - client; LPC (Option), LAN (option)				

[1] For the refresh rates, see Table 5: Refresh Rate: DP & DVI Digital and Refresh Rate: DVI Analog.



Table 4: Technical Specification for Display sizes - continued

Display Size	15.0"	15.6"	15.6"	15.6" Slim
Resolution (pixels) <sup>[1]</sup>	1024x768	1366x768, HD	1920x1080, Full HD	1920x1080, Full HD
Format	4:3	16:9	16:9	16:9
Contrast Ratio	700:1	500:1	500:1	800:1
Brightness	500 cd	300 cd	400 cd	450 cd
Angle View	H160°/V140°	H160°/V160°	H140°/V120°	H178°/V178°
Colors	16.7 million	16.7 million	16.2 million	16.7 million
LED Lifetime (> 50%, 25°C)	> 50,000 h	> 50,000 h	> 50,000 h	> 50,000 h
<b>Housing</b>				
Dimensions WxHxD (mm)	396 x 312 x 69	432 x 281 x 74	432 x 281 x 74	399 x 260 x 74
Weight	~ 6.4 kg	~ 6.7 kg	~ 6.7 kg	~ 6.5 kg
Protection glass	option	option	option	option
PCAP (Multi-touch)	option	option	option	option
Resistive touch	option	option	option	option
Color	RAL 7021 (black anthracite)			
Mounting	VESA 75/75 mm or 100/100 mm (full metal housing only) Clamping brackets (built-in-variant only) 19"rackmount (FlatView RCK with 19.0" display, other on request)			
Cooling	Fanless passive cooling			
Protection Class	Front: IP65, Housing IP20			
<b>Power Specification</b>				
Input Voltage (Range)	12 VDC to 30 VDC	12 VDC to 30 VDC	12 VDC to 30 VDC	12 VDC to 30 VDC
Input Current (@ 12 V)	1.5 A	1.6 A	1.6 A	1.6 A
Power Consumption (max.)	19.4 W +-5%	21.8 W +-5%	21.8 W +-5%	21.8 W +-5%
Power Supply	12 VDC -30 VDC Input via Phoenix Connector PSC 1,5/3-F			
<b>I/O</b>				
Video IN	1x DVI, 1x Display Port			
I/O Options	USB 2.0 (Type B) - client; LPC (Option), LAN (option)			

<sup>[1]</sup>For the refresh rates, see Table 5: Refresh Rate: DP & DVI Digital and Refresh Rate: DVI Analog.

Table 4 Technical Specification for Display sizes - continued

Display Size	17.0"	18.5"	18.5"	18.5" Slim
Resolution (pixels) <sup>[1]</sup>	1280x1024 SXGA	1366x768, HD	1920x1080, Full HD	1920x1080 Full HD
Format	5:4	16:9	16:9	16:9
Contrast Ratio	800:1	1000:1	1000:1	800:1
Brightness	350 cd	300 cd	350 cd	350 cd
Angle View	H160°/V140°	H178°/V170°	H178°/V178°	H178°/V178°
Colors	16.7 million	16.7 million	16.7 million	16.7 million
LED Lifetime (> 50%, 25°C)	> 50,000 h	> 50,000 h	> 50,000 h	> 50,000 h
<b>Housing</b>				
Dimensions WxHxD (mm)	427 x 360 x 74	500 x 321 x 74	500 x 321 x 74	465 x 299 x 74
Weight	~ 7.8 kg	~ 8.6 kg	~ 8.6 kg	~ 8.4 kg
Protection glass	option	option	option	option
PCAP (Multi-touch)	option	option	option	option
Resistive touch	option	option	option	option
Color	RAL 7021 (black anthracite)			
Mounting	VESA 75/75 mm or 100/100 mm (full metal housing only) Clamping brackets (built-in-variant only) 19"rackmount (FlatView RCK with 19.0" display, other on request)			
Cooling	Fanless passive cooling			
Protection Class	Front: IP65, Housing IP20			
<b>Power Specification</b>				
Input Voltage (Range)	12 VDC to 30 VDC	12 VDC to 30 VDC	12 VDC to 30 VDC	12 VDC to 30 VDC
Input Current (@ 12 V)	2.4 A	2.3 A	2.3 A	2.3 A
Power Consumption (max.)	31.6 W +-5%	30.2 W +-5%	30.2 W +-5%	30.2 W +-5%
Power Supply	12 VDC -30 VDC Input via Phoenix Connector PSC 1,5/3-F			
<b>I/O</b>				
Video IN	1x DVI, 1x Display Port			
I/O Options	USB 2.0 (Type B) - client; LPC (Option), LAN (option)			

<sup>[1]</sup>For the refresh rates, see Table 5: Refresh Rate: DP & DVI Digital and Refresh Rate: DVI Analog

Table 4 Technical Specification for Display sizes - continued

Display Size	19.0"	21.5"	21.5" Slim	23.8"
Resolution (pixels) <sup>[1]</sup>	1280x1024 SXGA	1920x1080, Full HD	1920x1080, Full HD	1920x1080, Full HD
Format	5:4	16:9	16:7	16:9
Contrast Ratio	1000:1	3000:1	800:1	1000:1
Brightness	350 cd	300 cd	300 cd	250cd
Angle View	H170°/V160°	H178°/V178°	H178°/V178°	H178°/V178°
Colors	16.7 million	16.7 million	16.7 million	16.7 million
LED Lifetime (> 50%, 25°C)	> 50,000 h	> 50,000 h	> 50,000 h	> 30,000h
<b>Housing</b>				
Dimensions WxHxD (mm)	473 x 396 x 68	575 x 367 x 74	533 x 339 x 74	569 x 357 x 69
Weight	~ 9.4 kg	~ 10.7 kg	~ 10.5 kg	~ 11.8 kg
Protection glass	option	option	option	option
PCAP (Multi-touch)	option	option	option	option
Resistive touch	option	option	option	On request
Color	RAL 7021 (black anthracite)			
Mounting	VESA 75/75 mm or 100/100 mm (full metal housing only) Clamping brackets (built-in-variant only) 19" rackmount (FlatView RCK with 19.0" display, other on request)			
Cooling	Fanless passive cooling			
Protection Class	Front: IP65, Housing IP20			
<b>Power Specification</b>				
Input Voltage (Range)	12 VDC to 30 VDC	12 VDC to 30 VDC	12 VDC to 30 VDC	12 VDC to 30 VDC
Input Current (@ 12 V)	2.2 A	2.4 A	2.4 A	2.3 A
Power Consumption (max.)	28.8 W +-5%	32.1 W +-5%	32.1 W +-5%	30.5 W +-5%
Power Supply	12 VDC -30 VDC Input via Phoenix Connector PSC 1,5/3-F			
<b>I/O</b>				
Video IN	1x DVI, 1x Display Port			
I/O Options	USB 2.0 (Type B) - client; LPC (Option), LAN (option)			

<sup>[1]</sup>For the refresh rates, see Table 5: Refresh Rate: DP & DVI Digital and Refresh Rate: DVI Analog

## 6.1.1. Refresh Rates DP, DVI Digital and DVI Analog

Table 5: Refresh Rate: DP & DVI Digital and Refresh Rate: DVI Analog

Resolution	Refresh Rate: DP & DVI Digital					Refresh Rate: DVI Analog
720 x 400 DOS	70 Hz					
640 x 350 DOS	70 Hz					
640 x 400 DOS	70 Hz					
640 x 480 VGA	59.9 Hz	60 Hz	72 Hz	75 Hz		60 Hz
800 x 600 SVGA	56.25 Hz	60 Hz	70 Hz	72 Hz	75 Hz	60 Hz
1024 x 768 VGA	60 Hz	70 Hz	72 Hz	75 Hz		60 Hz
1152 x 864	60 Hz	70 Hz	75 Hz			
1280 x 1024 SXGA	60 Hz	70 Hz	75 Hz			60 Hz
1600 x 1200 UXGA	60 Hz					60 Hz
1920 x 1080 Full HD	60 Hz					60 Hz

## 6.2. Environmental Specification

Table 6: Environmental Specification

Operating Temperature	0°C to 50°C ambient
Storage Temperature	-10°C to 60°C ambient
Operating Altitude	Up to 3000 m (9900 ft.)
Storage Altitude	Up to 5000 m (16500 ft.)
Humidity	10% to 90% @ 39°C, non-condensing

### NOTICE

FlatView is intended for indoor use only. To avoid product damage do not use in a sheltered outdoor, outdoor or sunlit environment.

Observe that the product is not exposed to direct sunlight (UV radiation):

- Prolonged exposure shortens field life and voids the warranty
- Short exposure may lead to higher temperatures inside the product and cause permanent damage
- Direct exposure accelerates long-term aging

For intend use in an outdoor environment or a sunlit environment, contact your Kontron representative.

## 6.3. Power Specification

Before connecting the FlatView to an external DC power supply, ensure that the external DC power supply meets the electrical specification on the product's Type Label (see Figure 2) and as specified in Table 4. The external DC power supply must automatically recover from AC power loss and startup under peak loading.

### ⚠ CAUTION

Only connect the product to an external power supply providing the voltage type (AC or DC) and the input power (max. current) specified on the Kontron Product Label.

The external power supply must meet the requirements of ES1/PS2 according to IEC/UL 62368-1.

Connectez le produit uniquement à une alimentation externe fournissant le type de tension (AC ou DC) et la puissance d'entrée (courant max.) spécifiés sur l'étiquette du produit Kontron. L'alimentation externe doit répondre aux exigences de ES1/PS2 selon IEC/UL 62368-1.

The external DC power supply must incorporate protection and supply features such as over current, over temperature, over voltage and brownout protection, to protect the FlatView against fluctuations and interruptions and ensure operation without loss of data or product damage.

### NOTICE

To protect the product and any connected peripherals, make sure that the power cables have the right diameter to withstand the maximum available current.

### NOTICE

If there is an unintentional voltage drop in the mains power supply for longer than the specified holdup time (brownout), all supply voltages should be shut down and remain in the off state long enough to allow internal voltages to discharge sufficiently. During the off state time do not disconnect or add cables to/from the I/O connectors. Failure to observe the off state time means that parts of the product or attached peripherals may work incorrectly or suffer a reduction of MTBF.

The minimum off state time, to allow internal voltages to discharge, depends on the power supply used and additional electrical factors. To determine the required off state time, each case must be considered individually. For more information, contact [Kontron Support](#).

## 6.4. Compliance

If modified, the prerequisites for specific approvals may no longer apply. Kontron is not responsible for any radio television interference caused by unauthorized modifications of the product or the substitution or attachment of connecting cables and equipment other than those specified by Kontron. The correction of interference caused by such unauthorized modification, substitution or attachment will be the responsibility of the user.

Table 7: Compliance

Low Voltage Directive	2014/35/EU	
General Product Safety Directive	2001/95/EG	
EMC Directive	2014/30/EU	
RoHS II Directives	2011/65/EU + 2015/863/EU + 2017/2102/EU	
CE Marking	CE, cULus	
EMC	EN 55032	Information technology equipment, Radio disturbance characteristics, Limits and methods of measurement (CISPR 32:2015)

<b>EMC</b>	EN 61000-6-2	Electromagnetic compatibility (EMC), Part 6-2: Generic Standards - Immunity for industrial environments+ CENELEC- Cor.:2005
<b>Safety</b>	EN 62368-1	Safety for information technology equipment including electrical business equipment

## 7/ Mechanical Diagrams

The mechanical dimensions for the FlatView series of industrial monitors are provided in this chapter.

### 7.1. 10.1" Mechanical Dimensions

#### 7.1.1. 10.1" Monitor Built-in

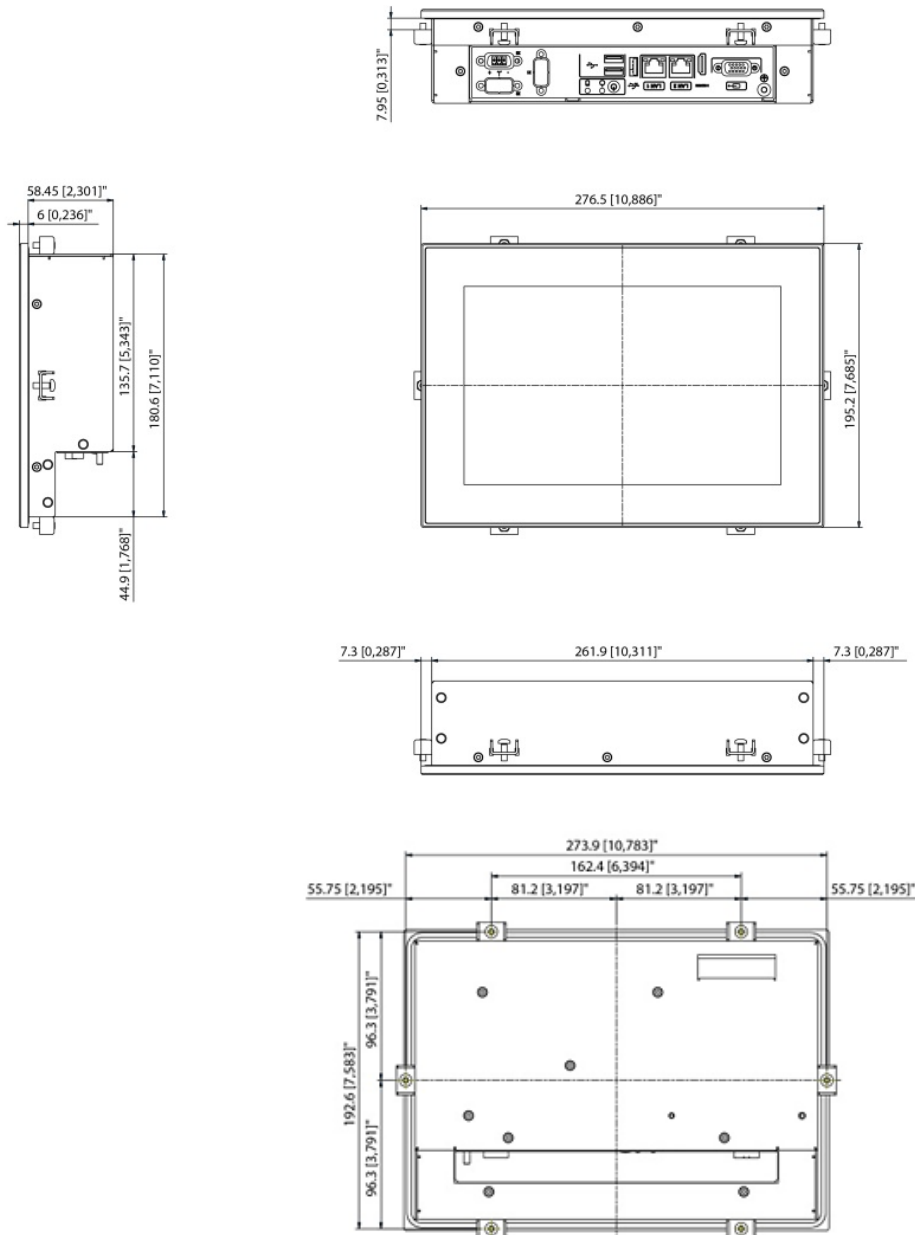

#### 7.1.1.1. 10.1" Panel Cutout

The built-in monitor's panel cutout dimensions are:

- ▶ Horizontal: 263.9 mm [10.390"]
- ▶ Vertical: 182.6 mm [7.189"]

## 7.2. 10.4" Mechanical Dimensions

### 7.2.1. 10.4" Monitor Built-in

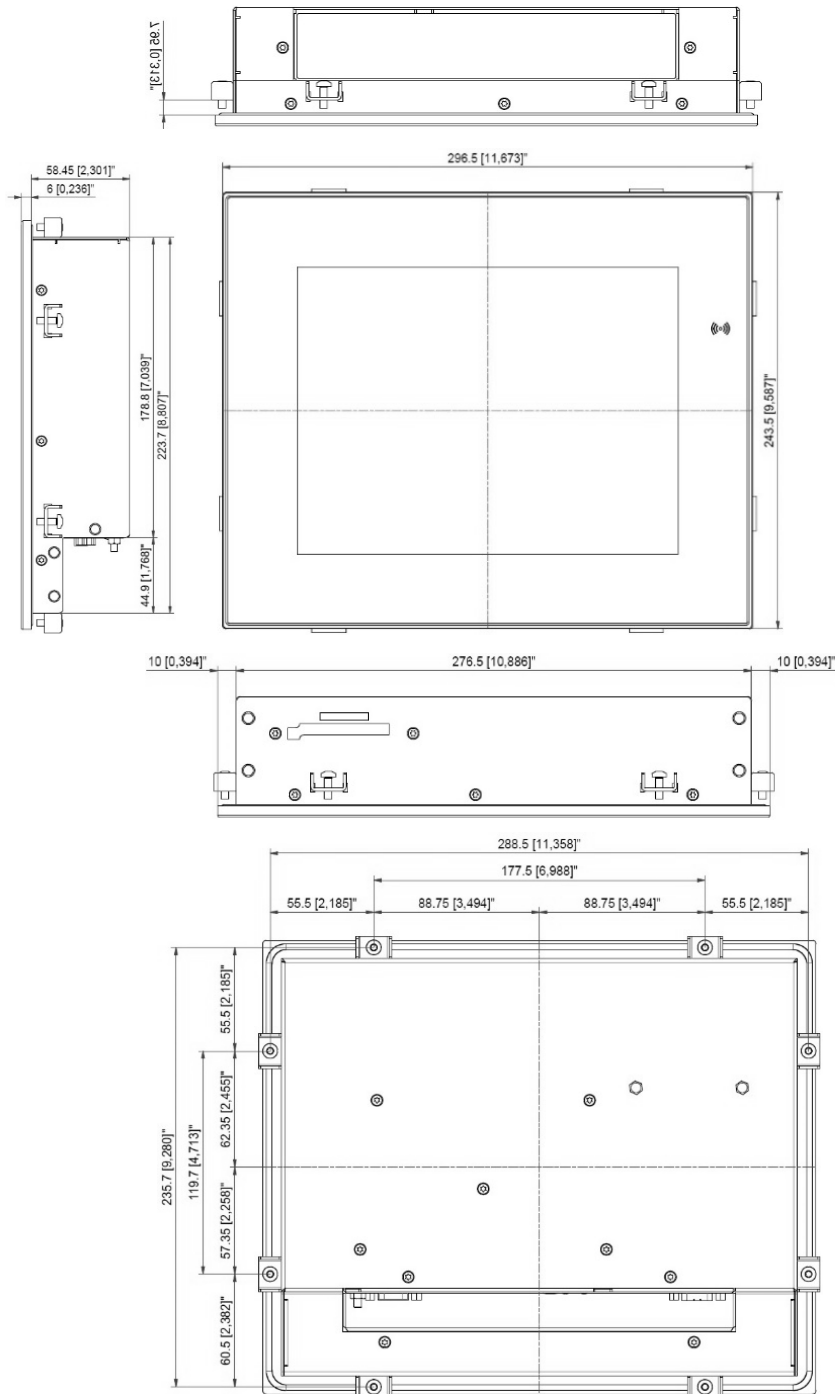

#### 7.2.1.1. 10.4" Panel Cutout Dimensions

The built-in monitor's panel cutout dimensions are:

- ▶ Horizontal: 278.5 mm [10.965"]
- ▶ Vertical: 225.7 mm [8.886"]



### 7.2.2. 10.4" Monitor VESA

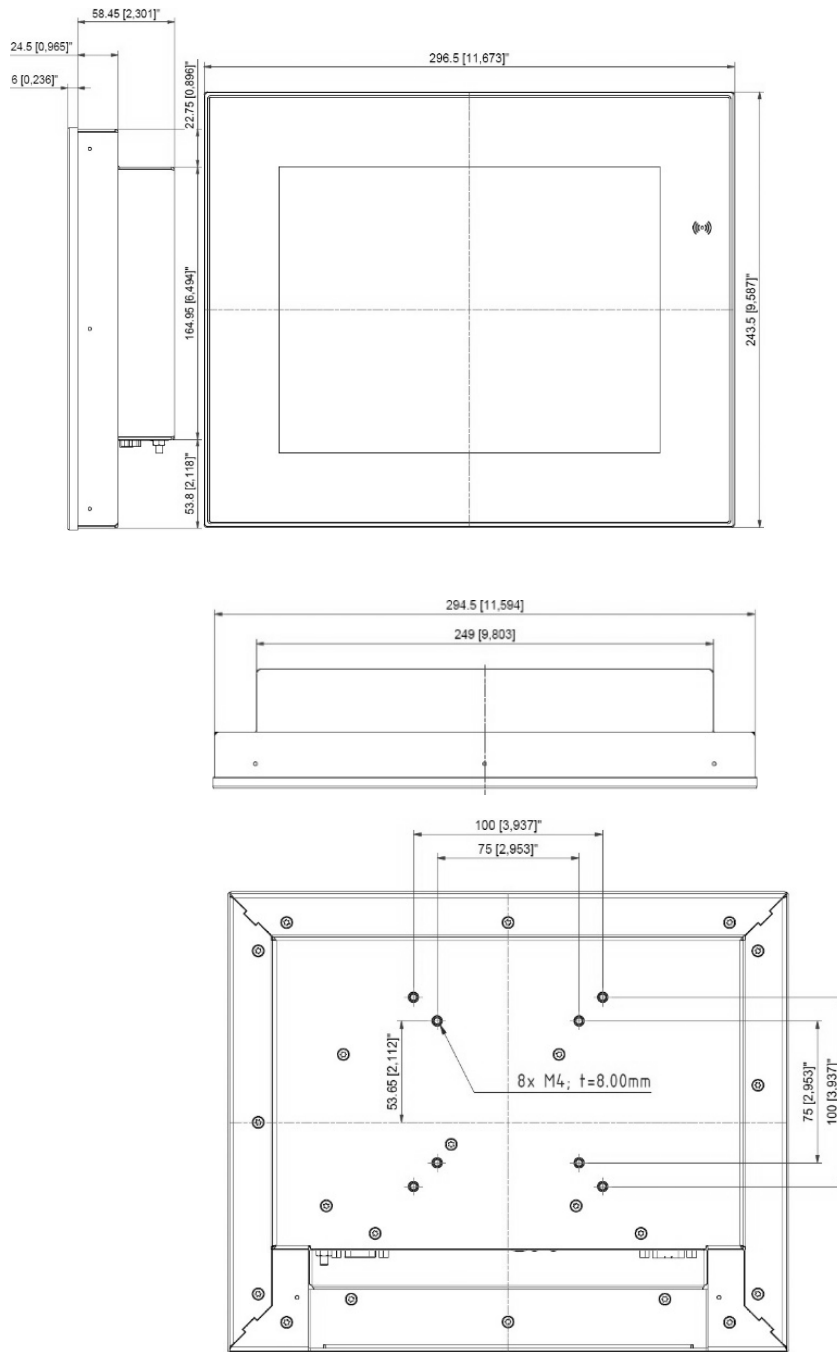

## 7.3. 12.1" Mechanical Dimensions

### 7.3.1. 12.1" Monitor Built-in (SVGA ,XGA)

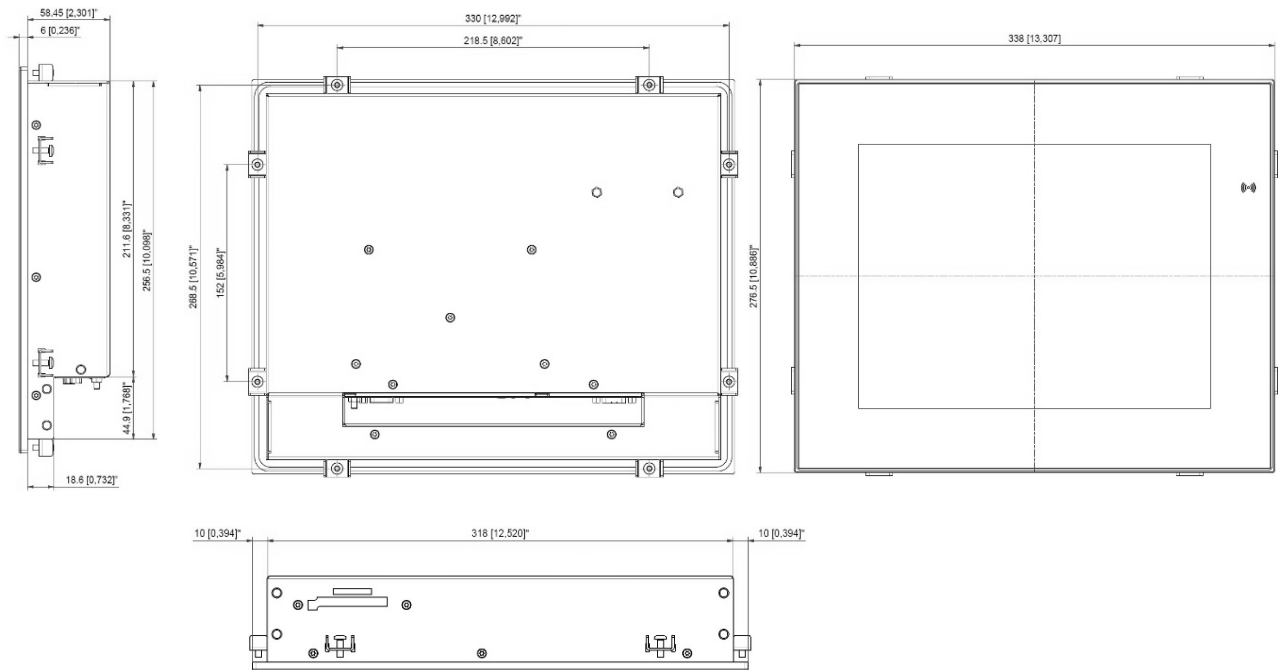

#### 7.3.1.1. 12.1" Panel Cutout Dimensions

The built-in monitor's panel cutout dimensions are:

- ▶ Horizontal: 320 mm [12.598"]
- ▶ Vertical: 258.5 mm [10.177"]

### 7.3.2. 12.1" Monitor VESA (SVGA, XGA)

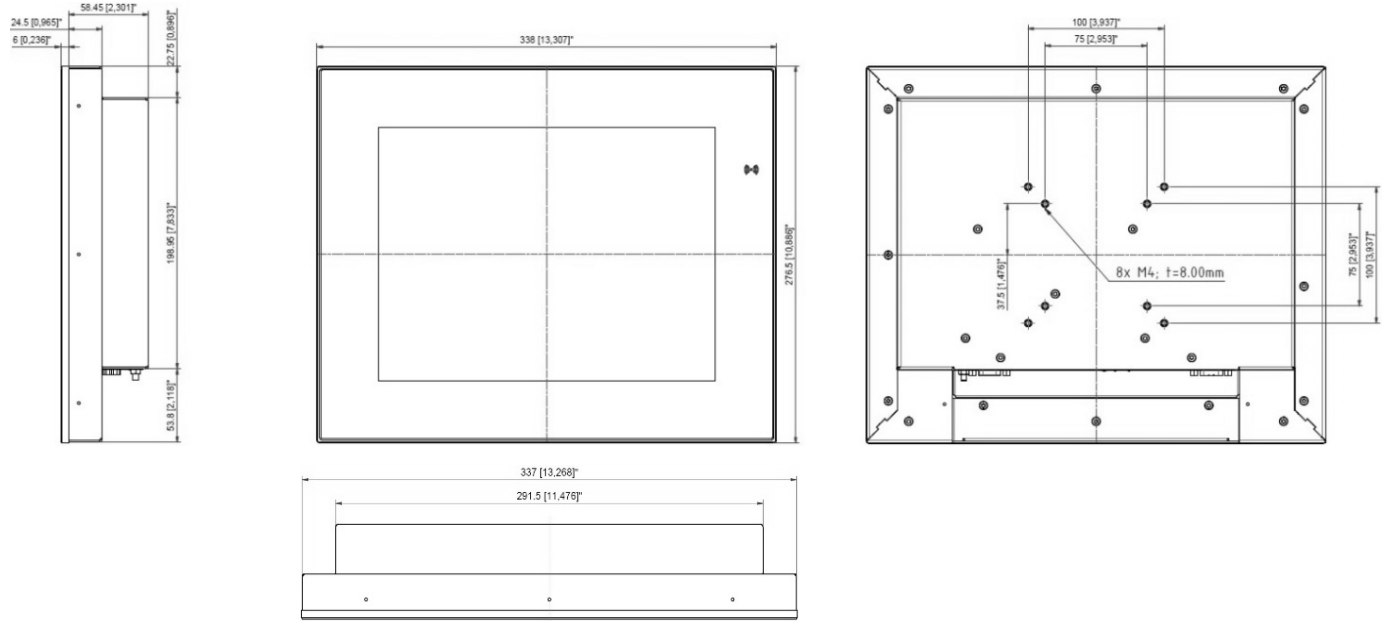

### 7.3.3. 12.1" Monitor Built-in (WXGA)

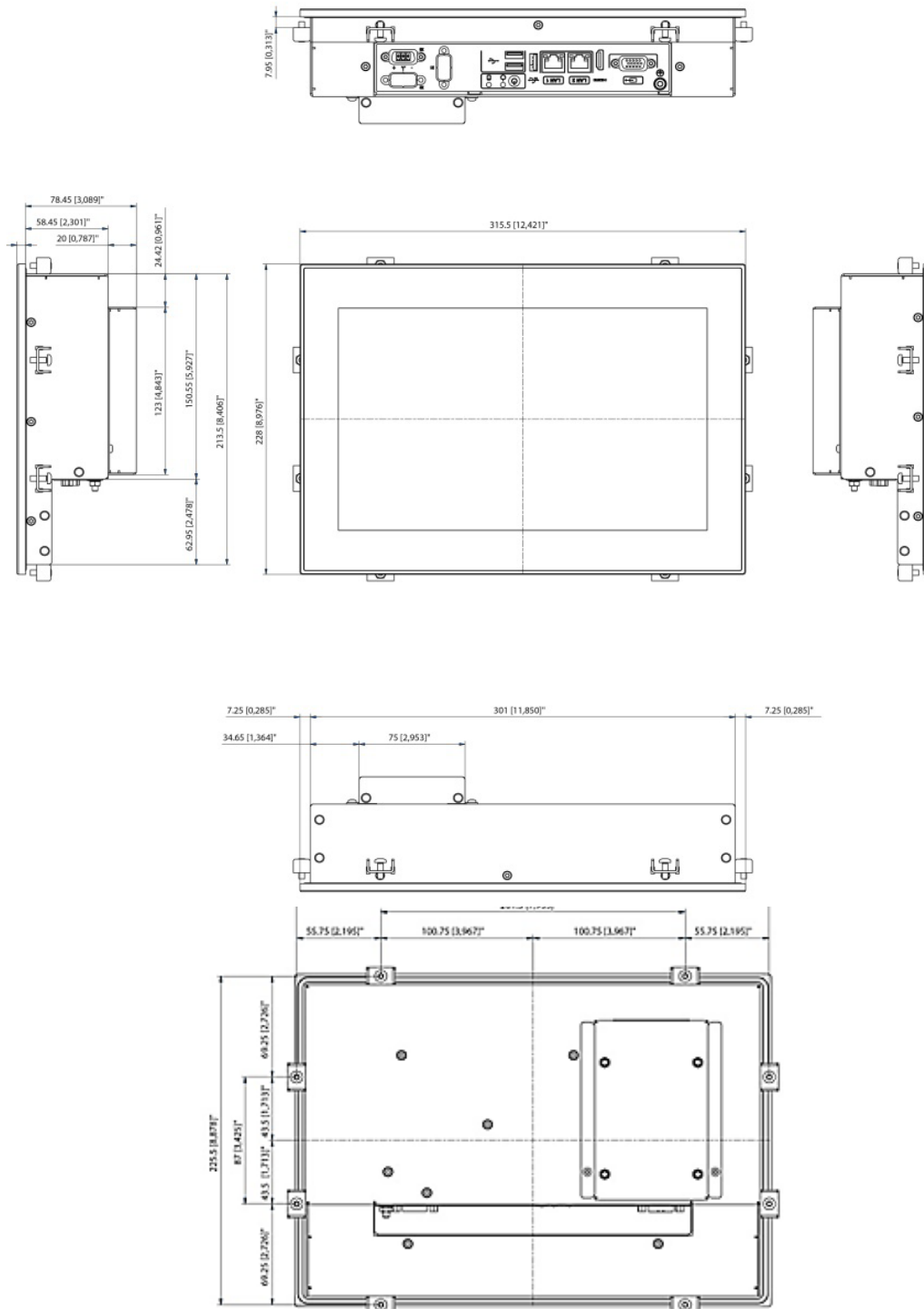

#### 7.3.3.1. 12.1" Panel Cutout Dimensions

The built-in monitor's panel cutout dimensions are:

- ▶ Horizontal: 303 mm [11.929"]
- ▶ Vertical: 215.5 mm [8.484"]

### 7.3.4. 12.1" Monitor VESA (WXGA)

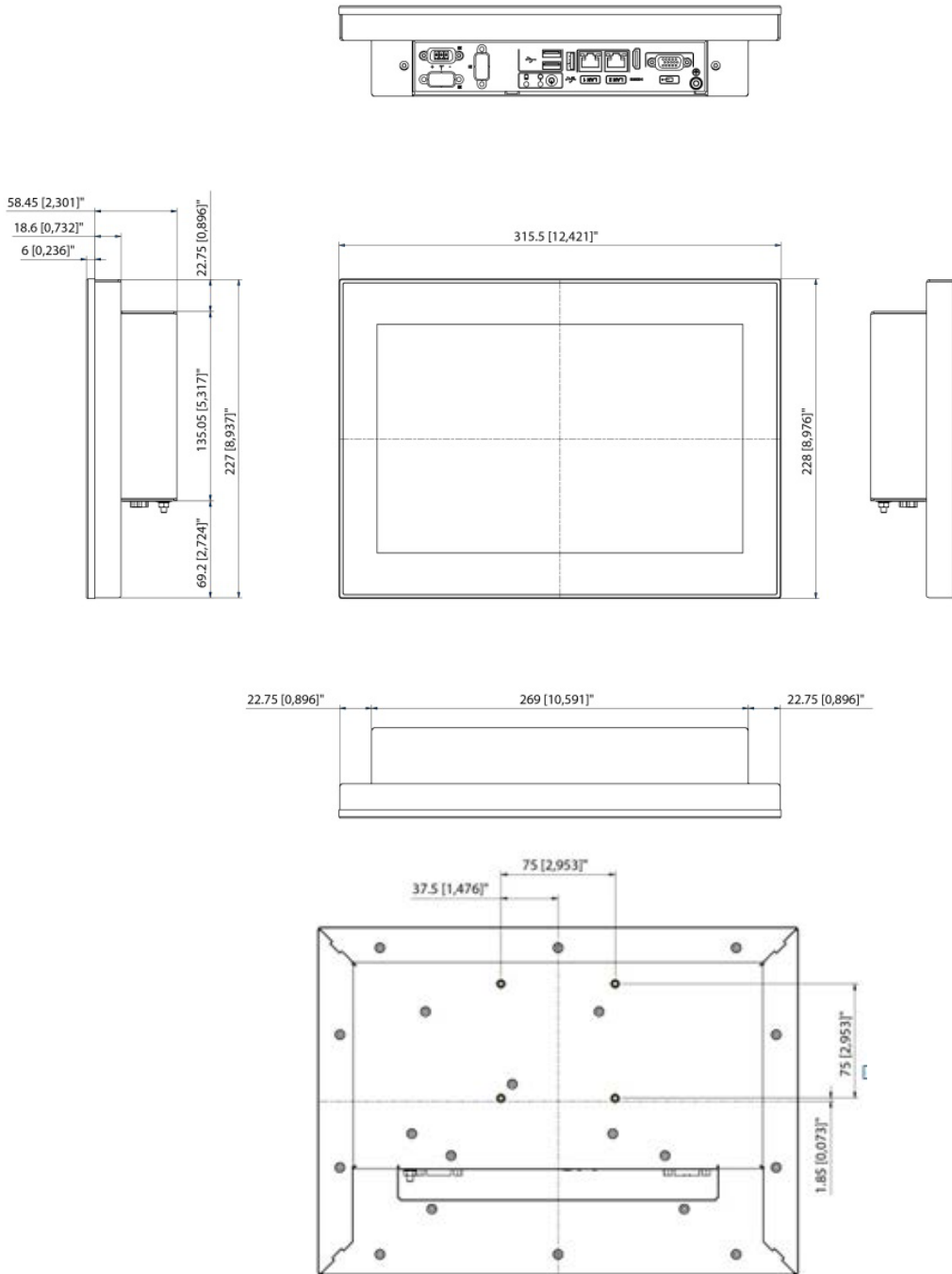

## 7.4. 15.0" Mechanical Dimensions

### 7.4.1. 15.0" Monitor Built-in

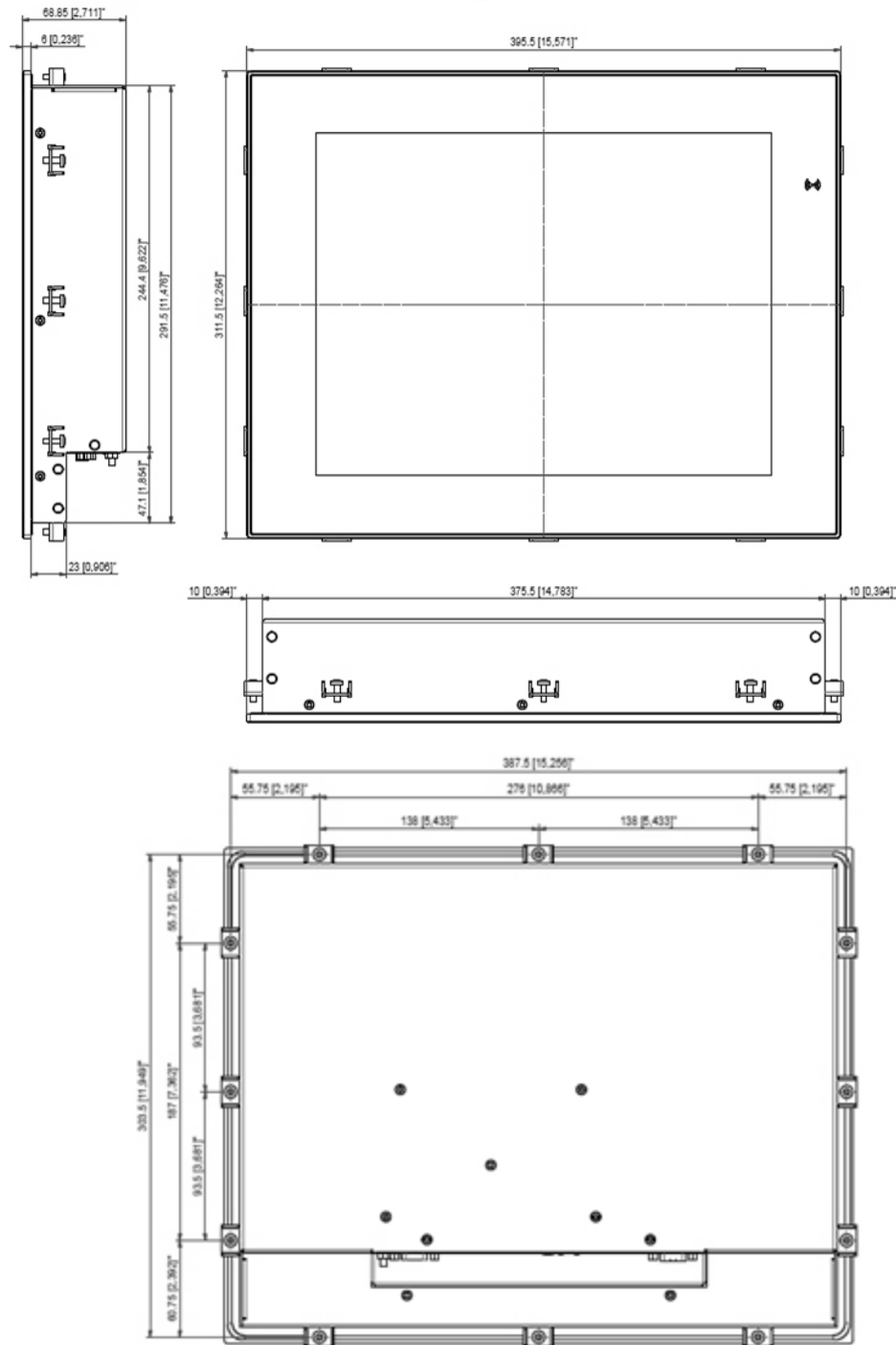

#### 7.4.1.1. 15.0" Panel Cutout Dimensions

The built-in monitor's panel cutout dimensions are:

- ▶ Horizontal: 377.5 mm [14.862"]
- ▶ Vertical: 293.5 mm [11.555"]

### 7.4.2. 15.0" Monitor VESA

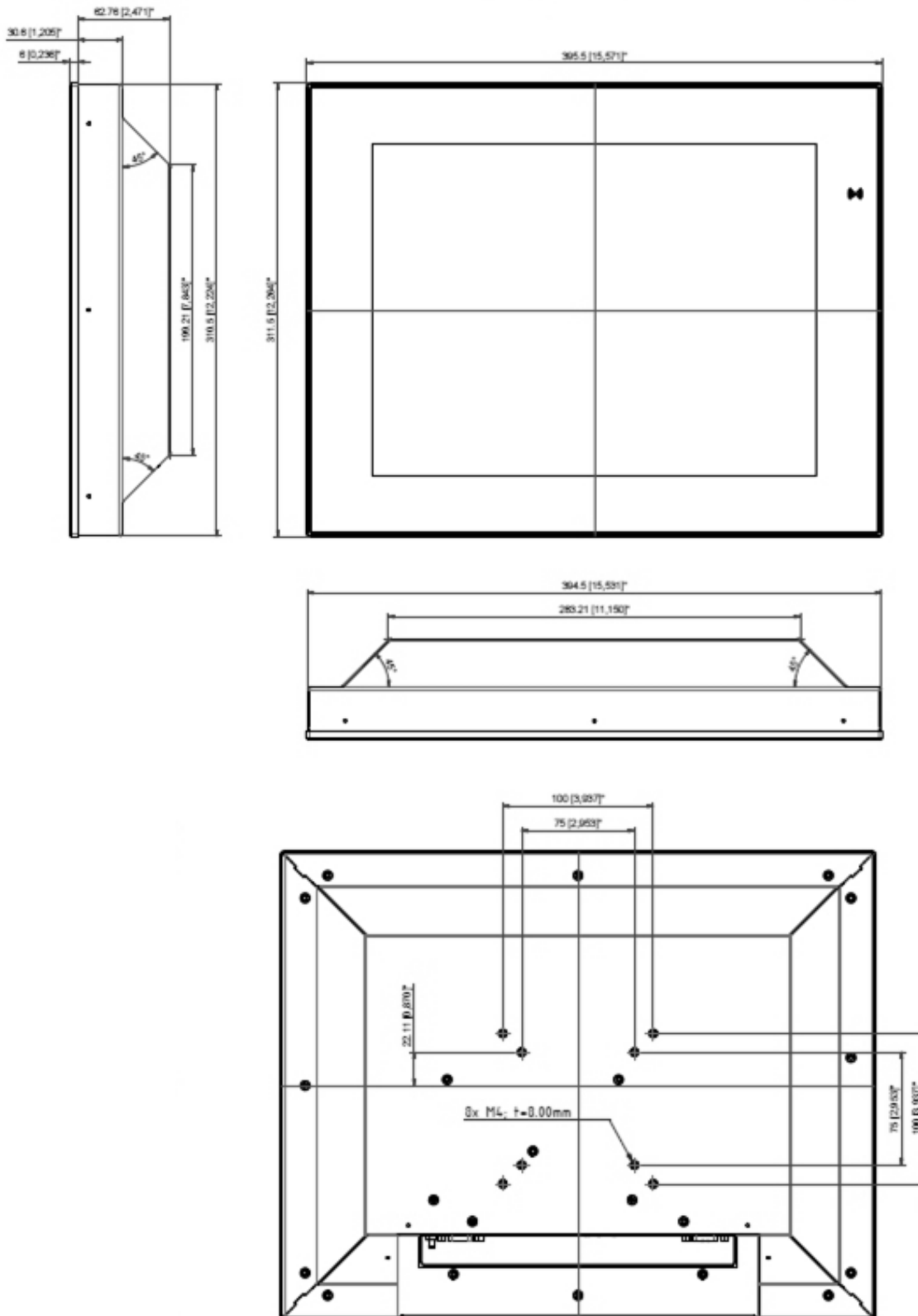

## 7.5. 15.6" Mechanical Dimensions

### 7.5.1. 15.6" Monitor Built-in (slim)

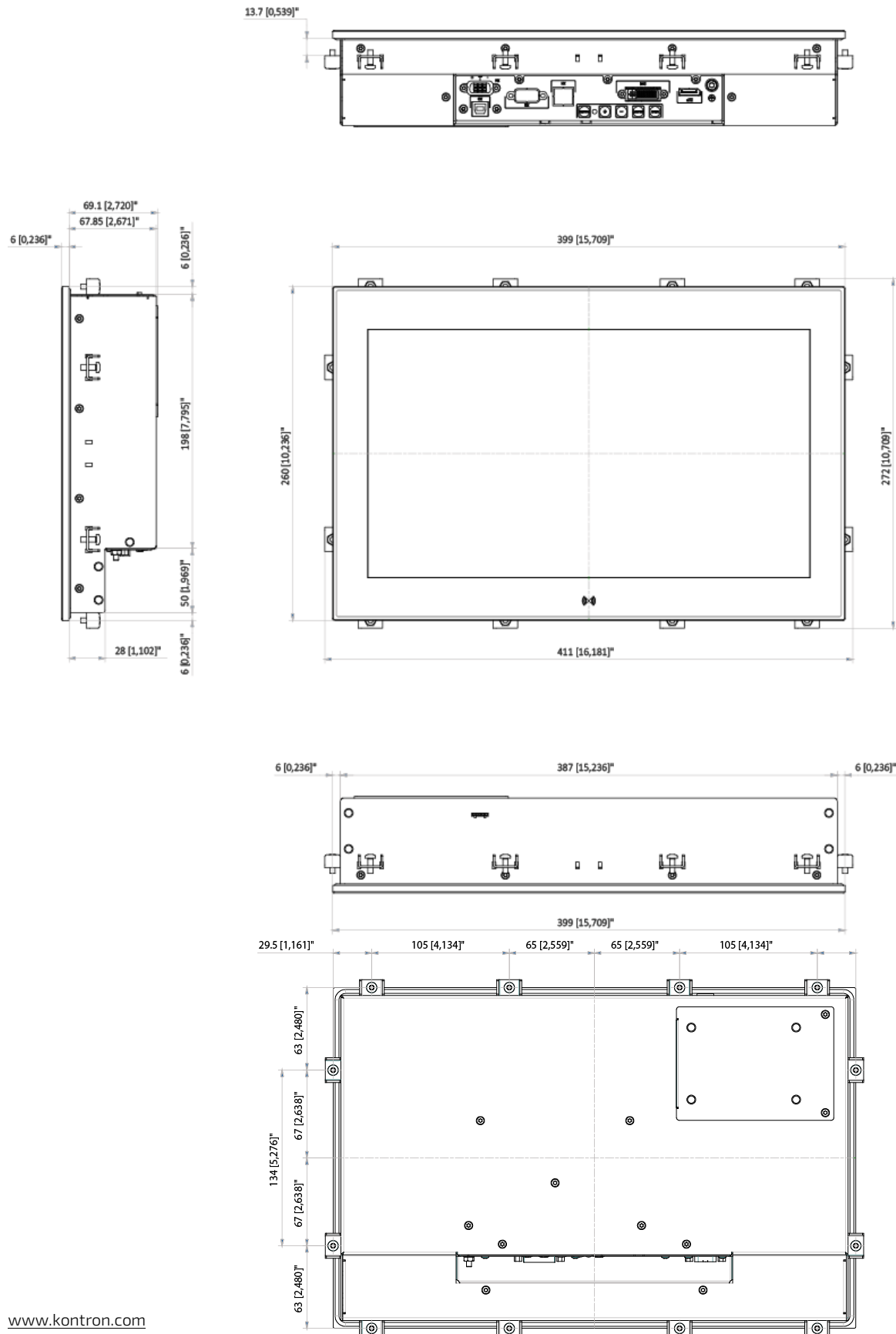



### 7.5.1.1. 15.6" (slim) Panel Cutout Dimensions

The built-in monitor's panel cutout dimensions are:

- ▶ Horizontal: 389 mm [15.315"]
- ▶ Vertical: 250 mm [9.842"]

### 7.5.2. 15.6" Monitor VESA (slim)

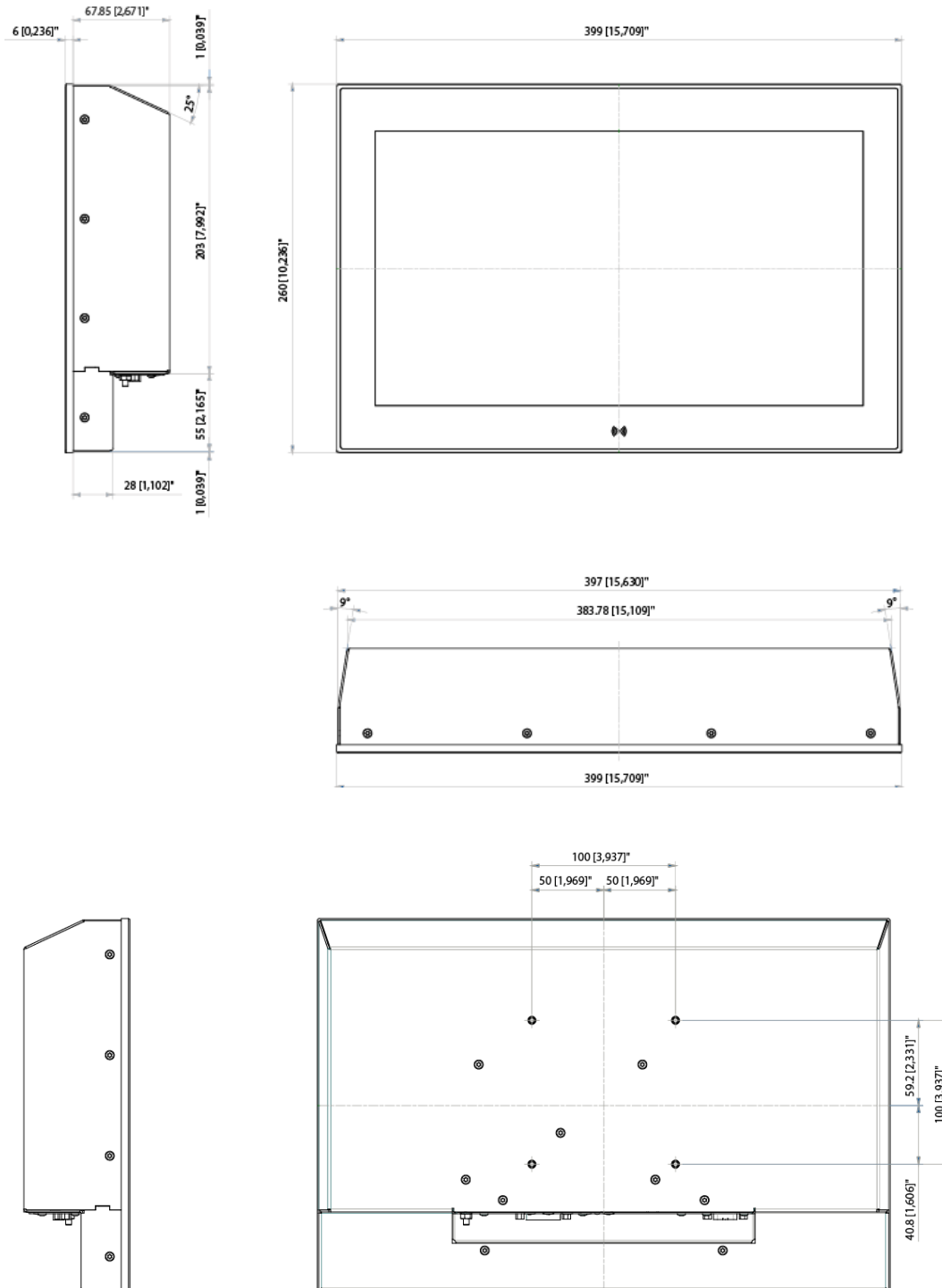

### 7.5.3. 15.6" Built-in Variant

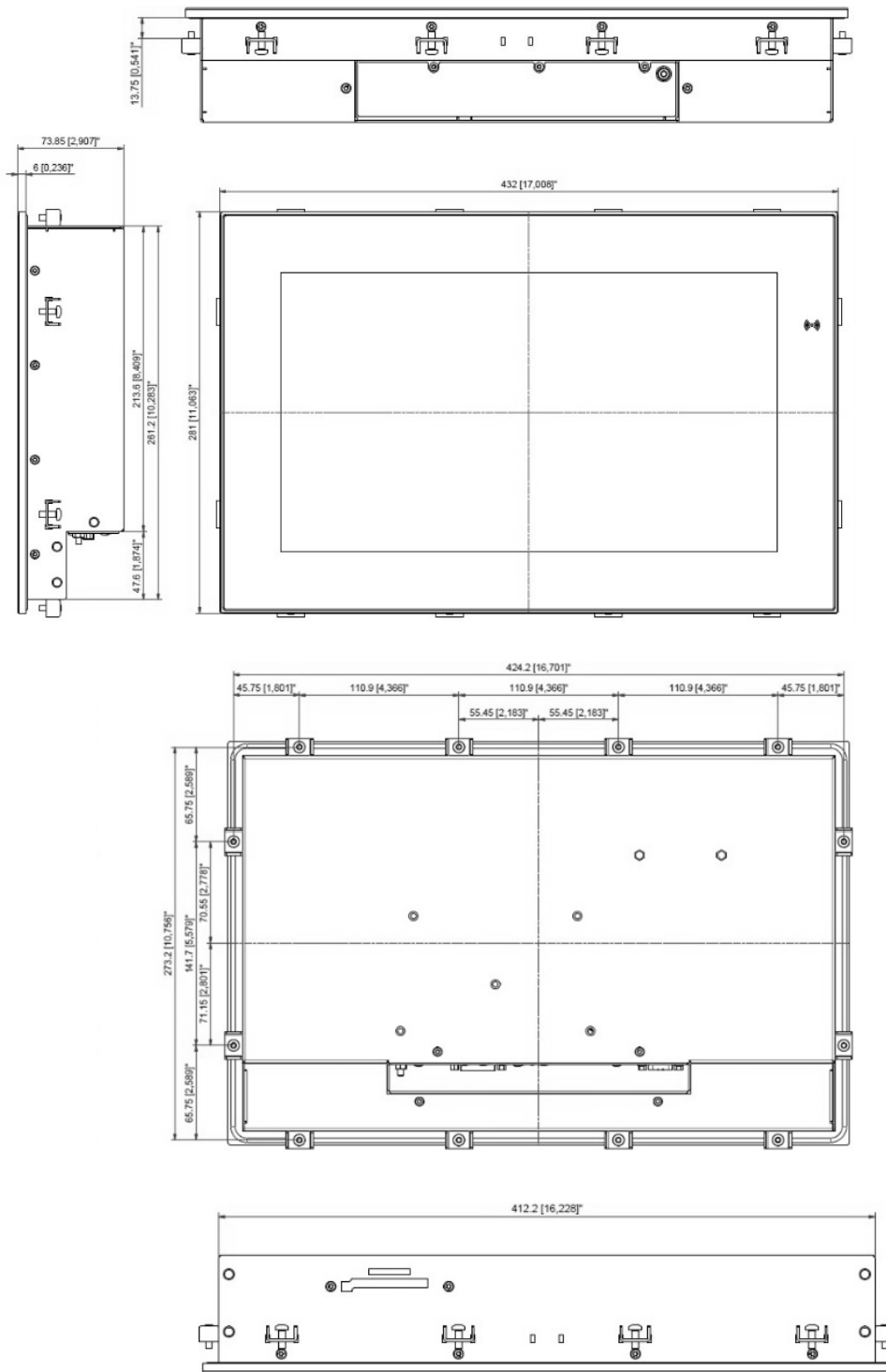

#### 7.5.3.1. 15.6" Panel Cutout Dimensions

The built-in monitor's panel cutout dimensions are:

- ▶ Horizontal: 414.2 mm [16.307"]
- ▶ Vertical: 263.2mm [10.362"]

### 7.5.4. 15.6" Monitor VESA

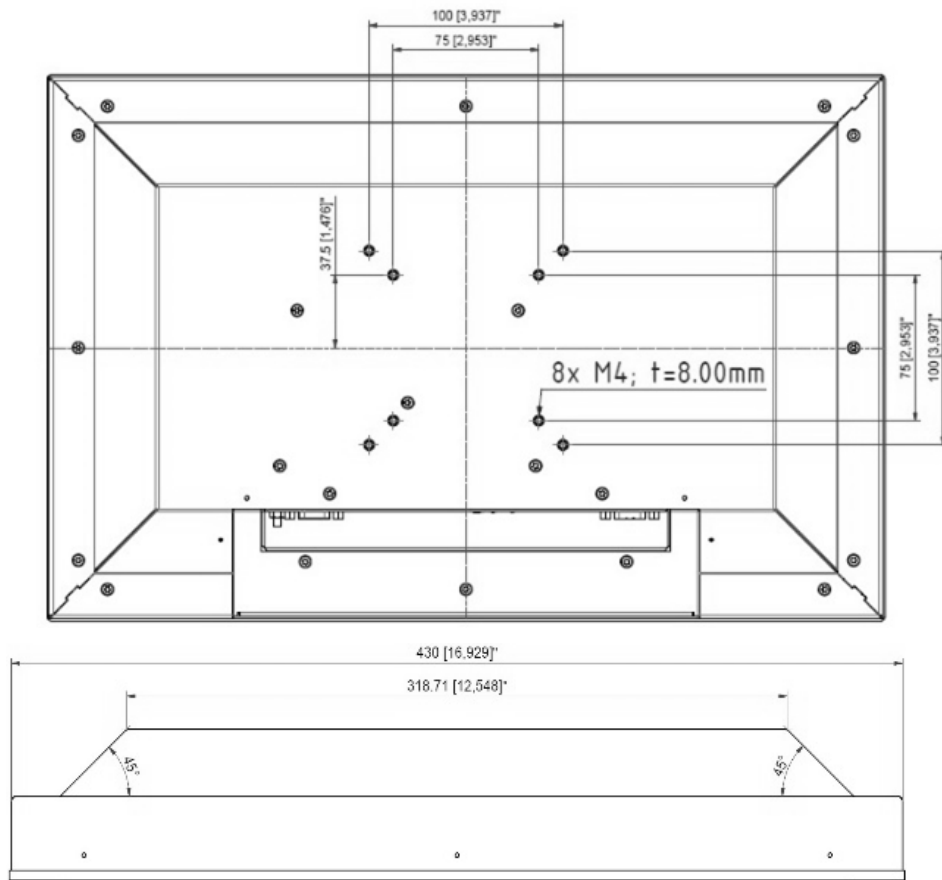
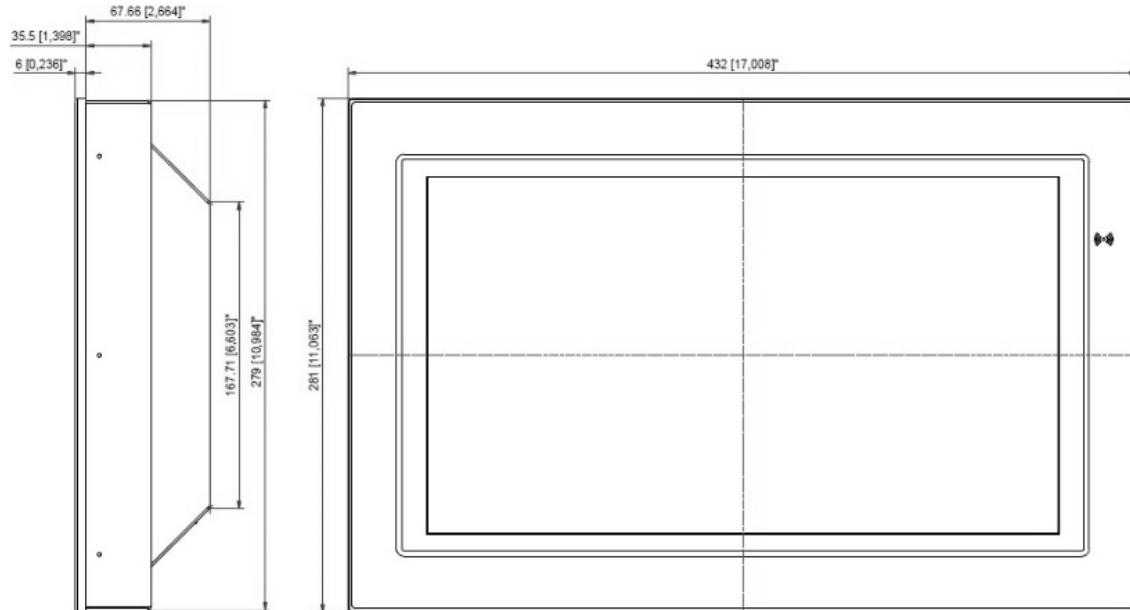

## 7.6. 17.0" Mechanical Dimensions

### 7.6.1. 17.0" Monitor Built-in

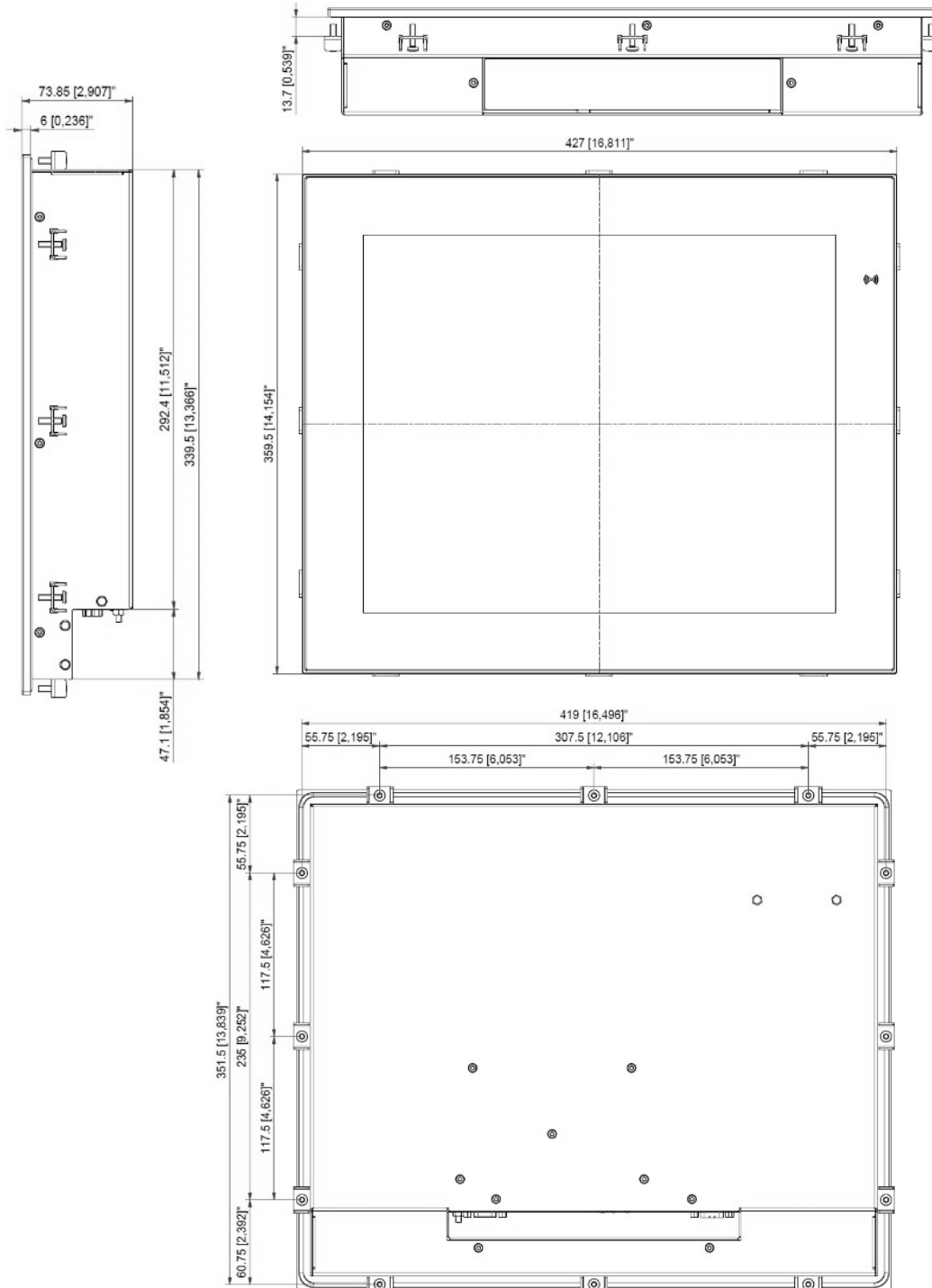

#### 7.6.1.1. 17.0" Panel Cutout Dimensions

The built-in monitor's panel cutout dimensions are:

- ▶ Horizontal: 409 mm [16.102"]
- ▶ Vertical: 341.5 mm [13.445"]

### 7.6.2. 17.0" Monitor VESA

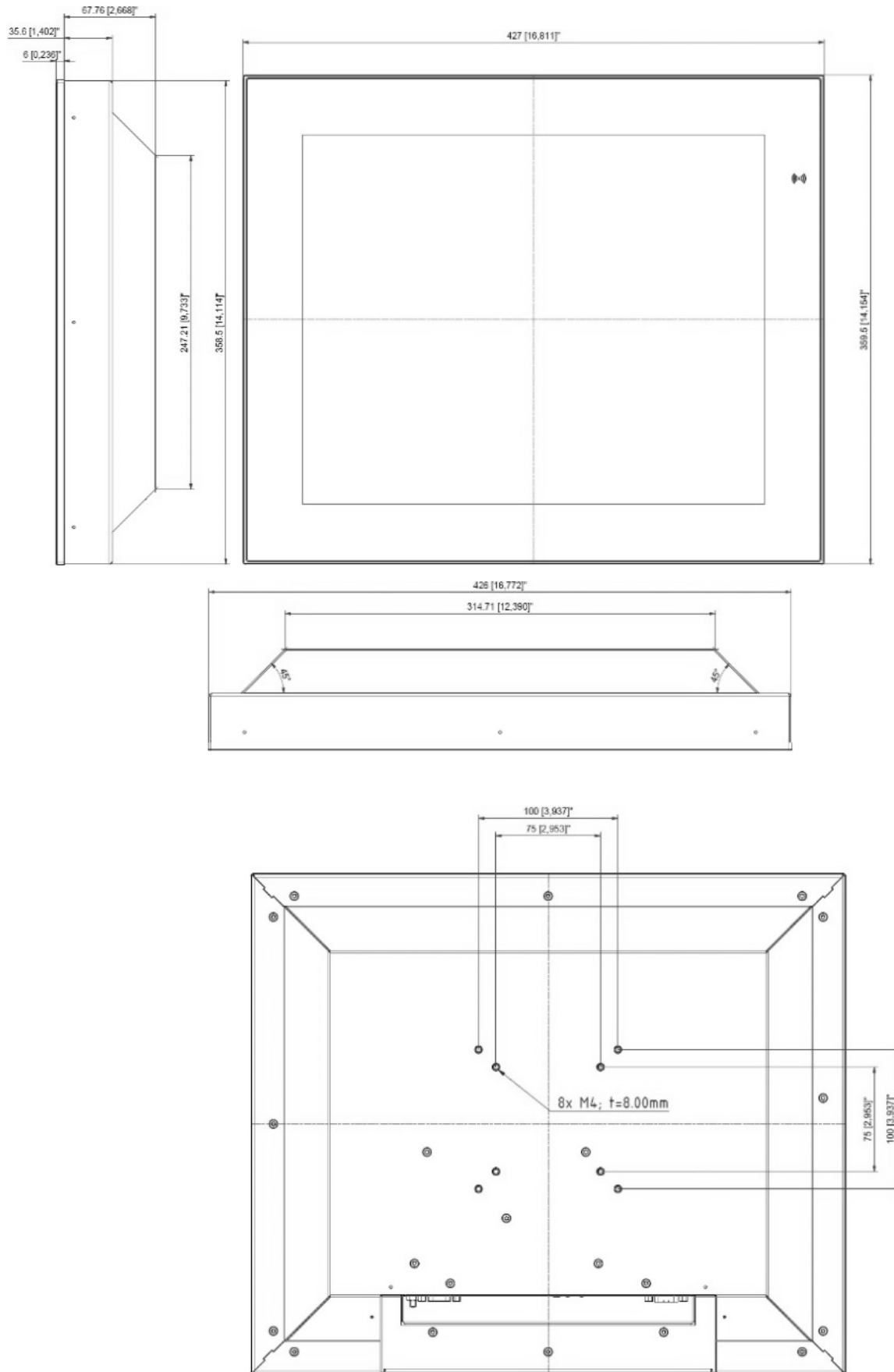

## 7.7. 18.5" Mechanical Dimensions

### 7.7.1. 18.5 Monitor Built-in (slim)

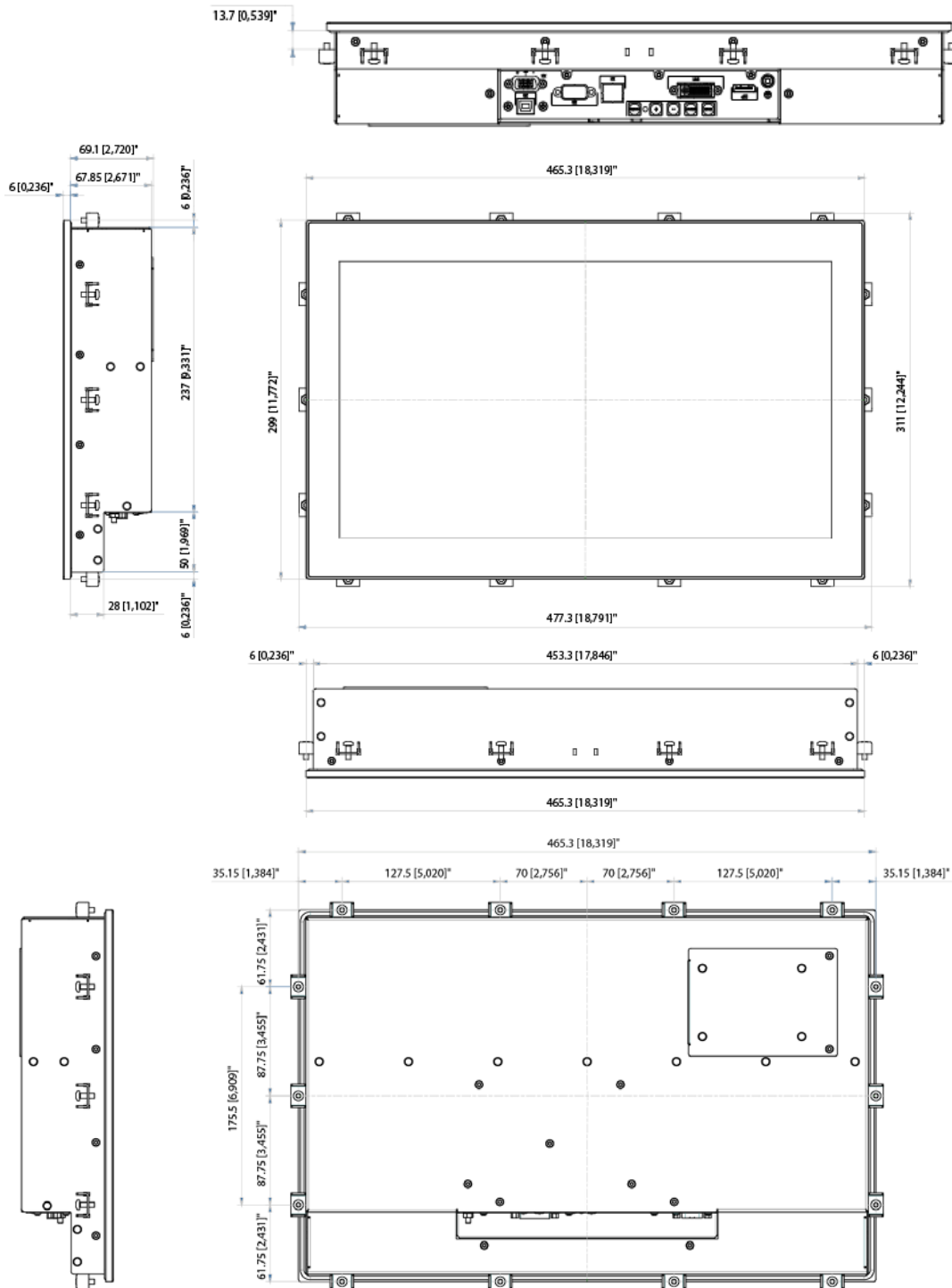

#### 7.7.1.1. 18.5" (slim) Panel Cutout Dimensions

The built-in monitor's panel cutout dimensions are:

- ▶ Horizontal: 455.3 mm [17.925"]
- ▶ Vertical: 289 mm [11.378"]

### 7.7.2. 18.5 Monitor VESA (slim)

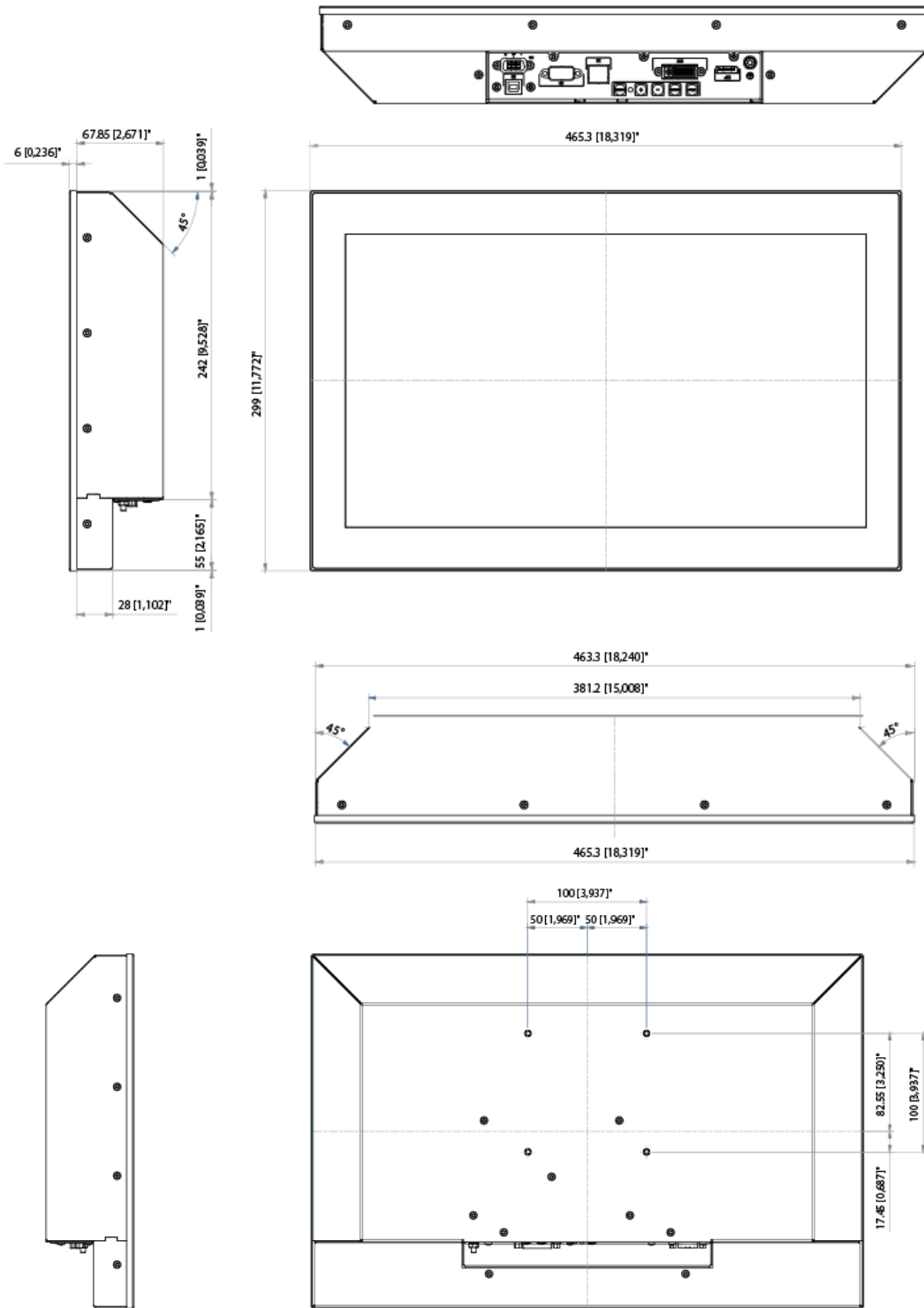

### 7.7.3. 18.5" Monitor Built-in (HD, Full HD)

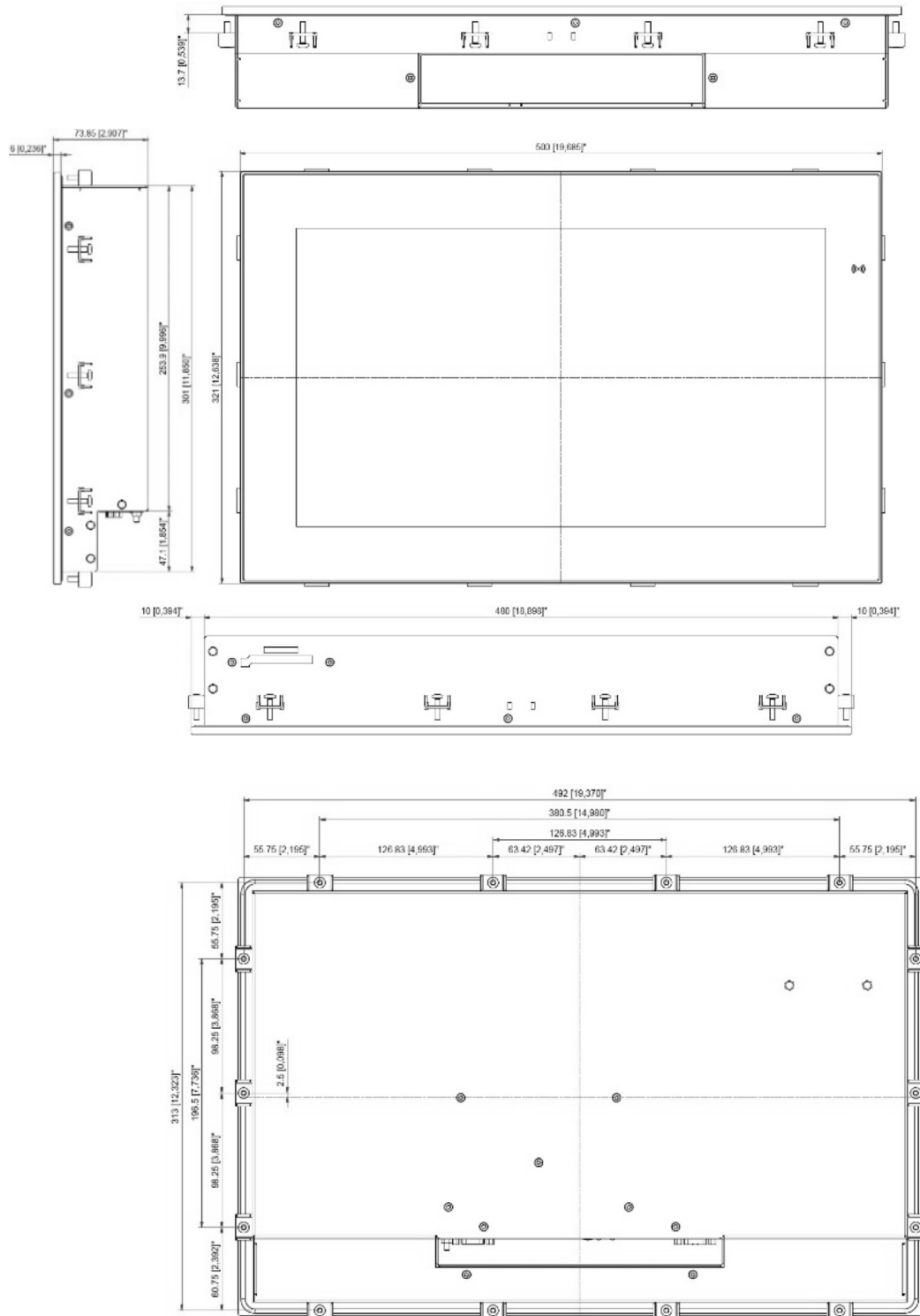

#### 7.7.3.1. 18.5" Panel Cutout Dimensions

The built-in monitor's panel cutout dimensions are:

- ▶ Horizontal: 482.5 mm [18.996"]
- ▶ Vertical: 303 mm [11.929"]



### 7.7.4. 18.5" Monitor VESA (HD, Full HD)

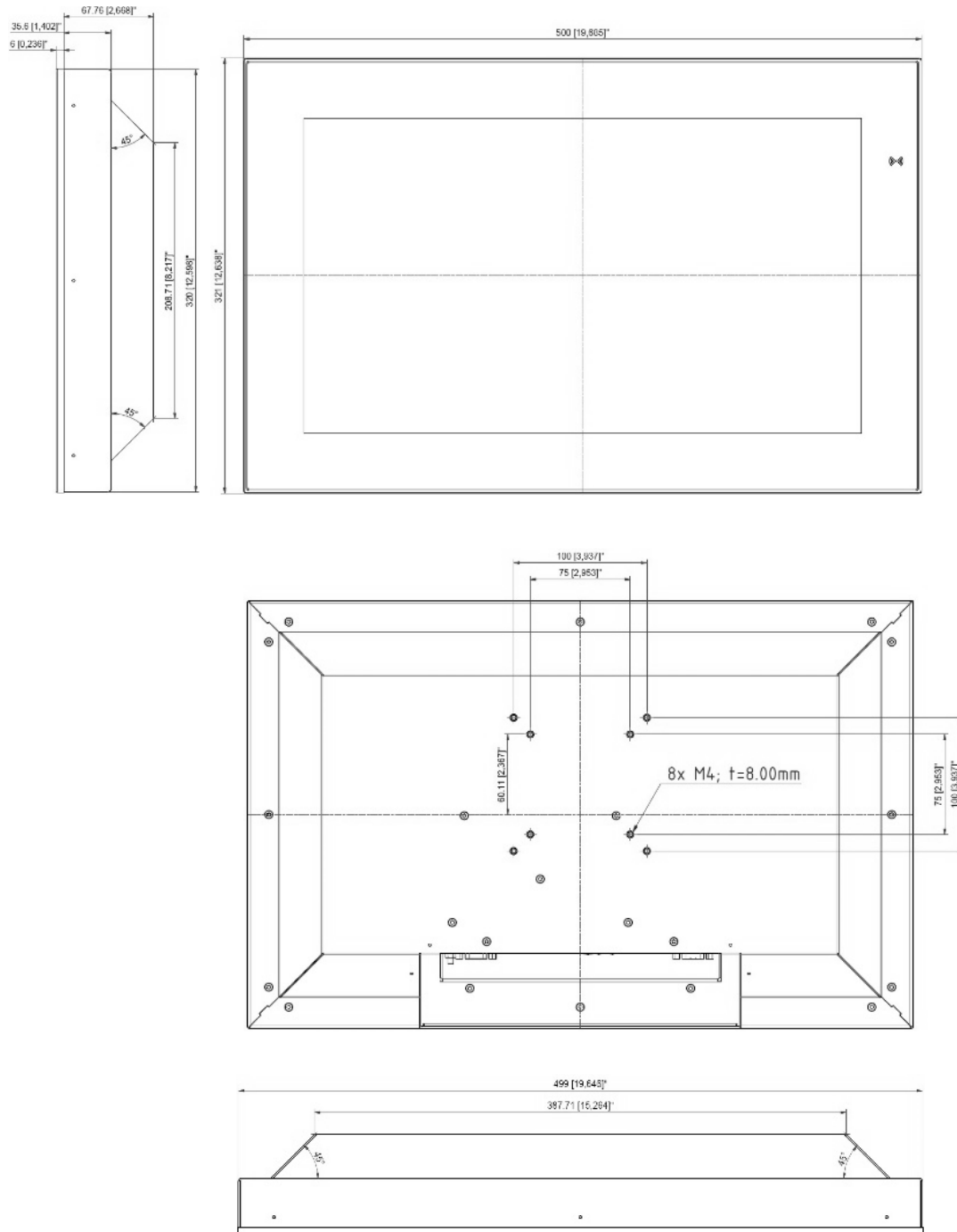

## 7.8. 19.0" Mechanical Dimensions

### 7.8.1. 19.0" Monitor Built-in

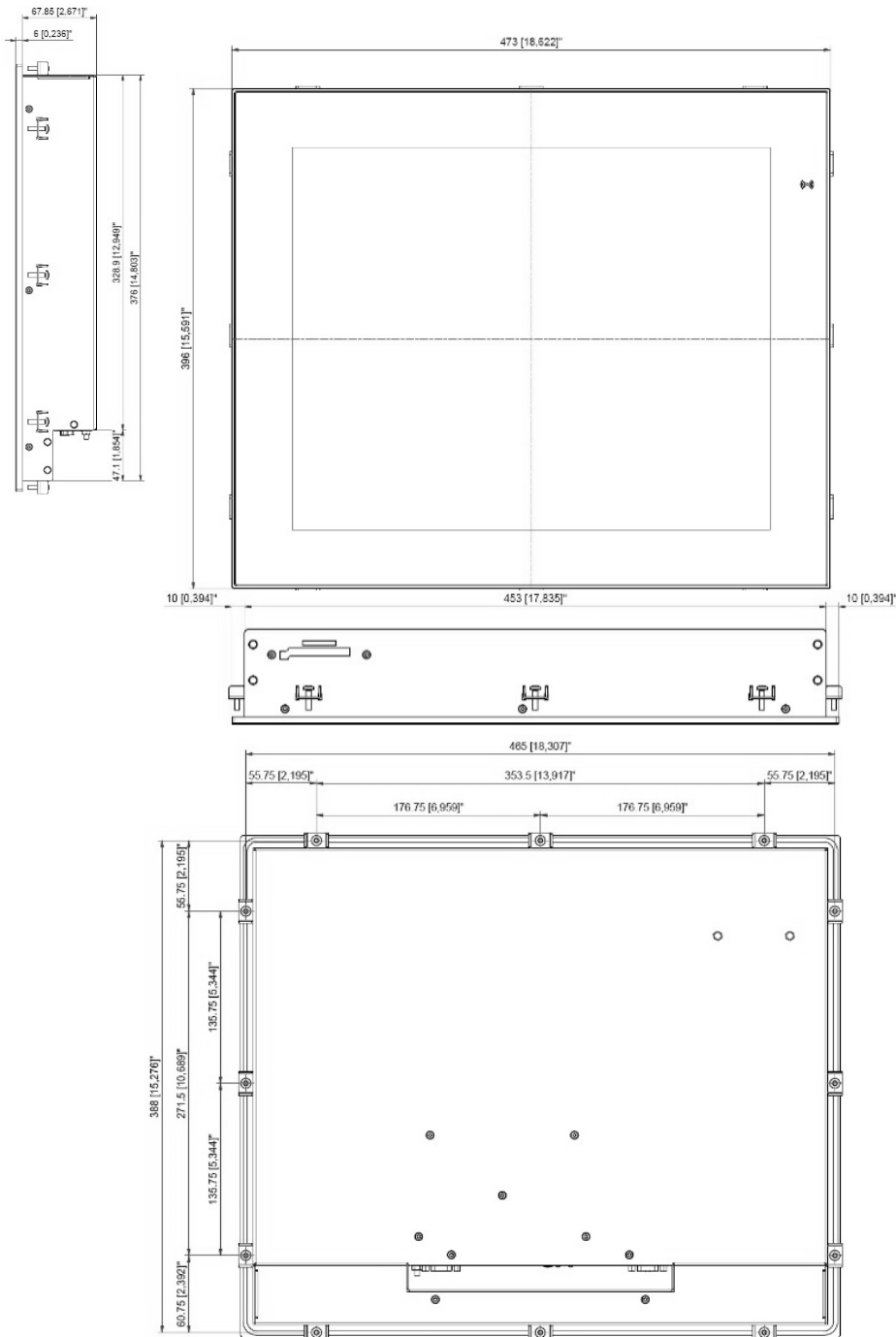

#### 7.8.1.1. 19.0" Panel Cutout Dimensions

The built-in monitor's panel cutout dimensions are:

- ▶ Horizontal: 455 mm [17.913"]
- ▶ Vertical: 378 mm [14.882"]

### 7.8.2. 19.0" Monitor VESA

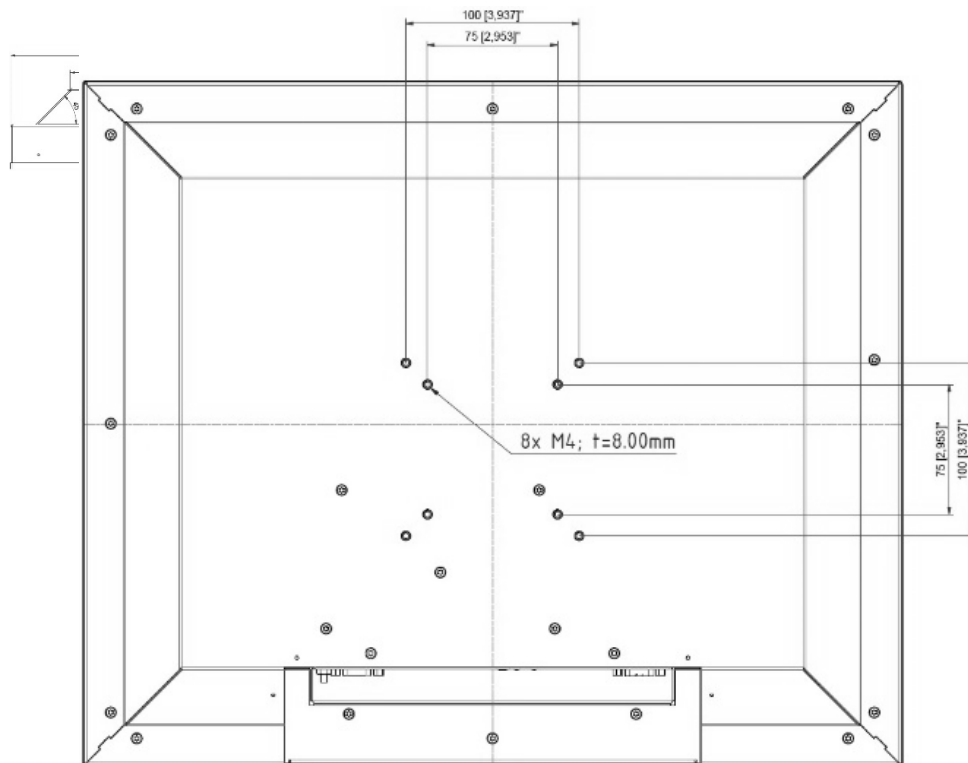
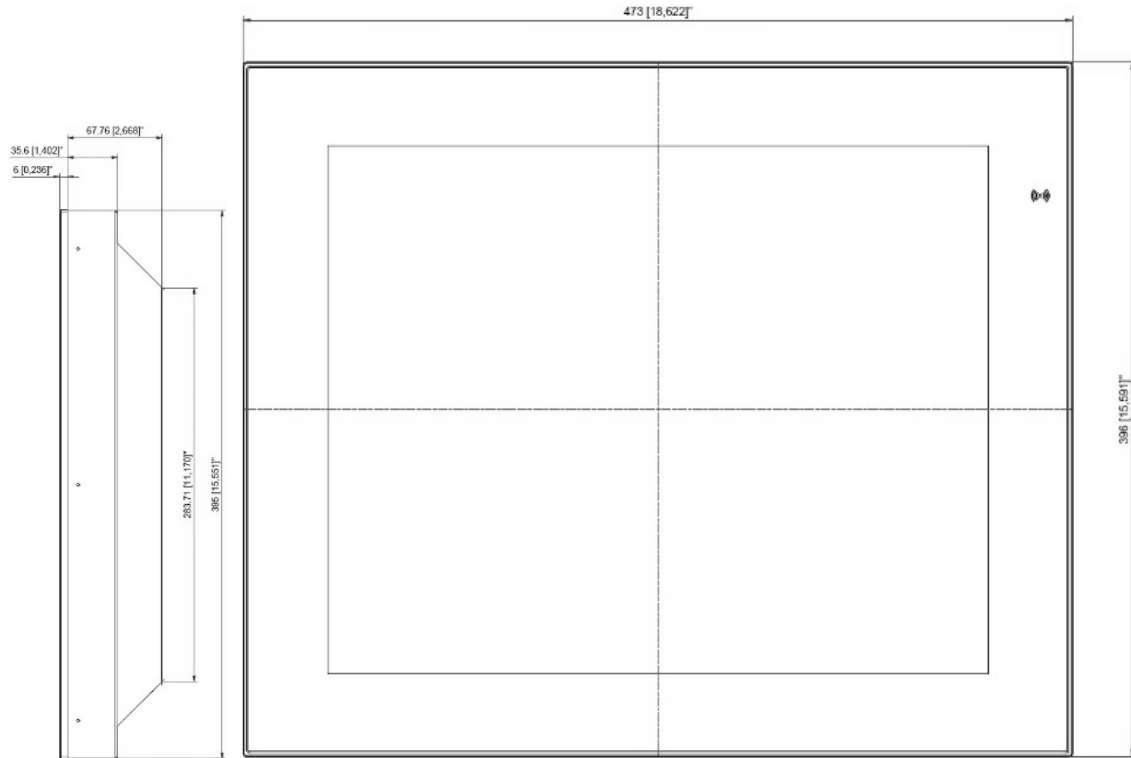

### 7.8.3. 19" Monitor Rackmount

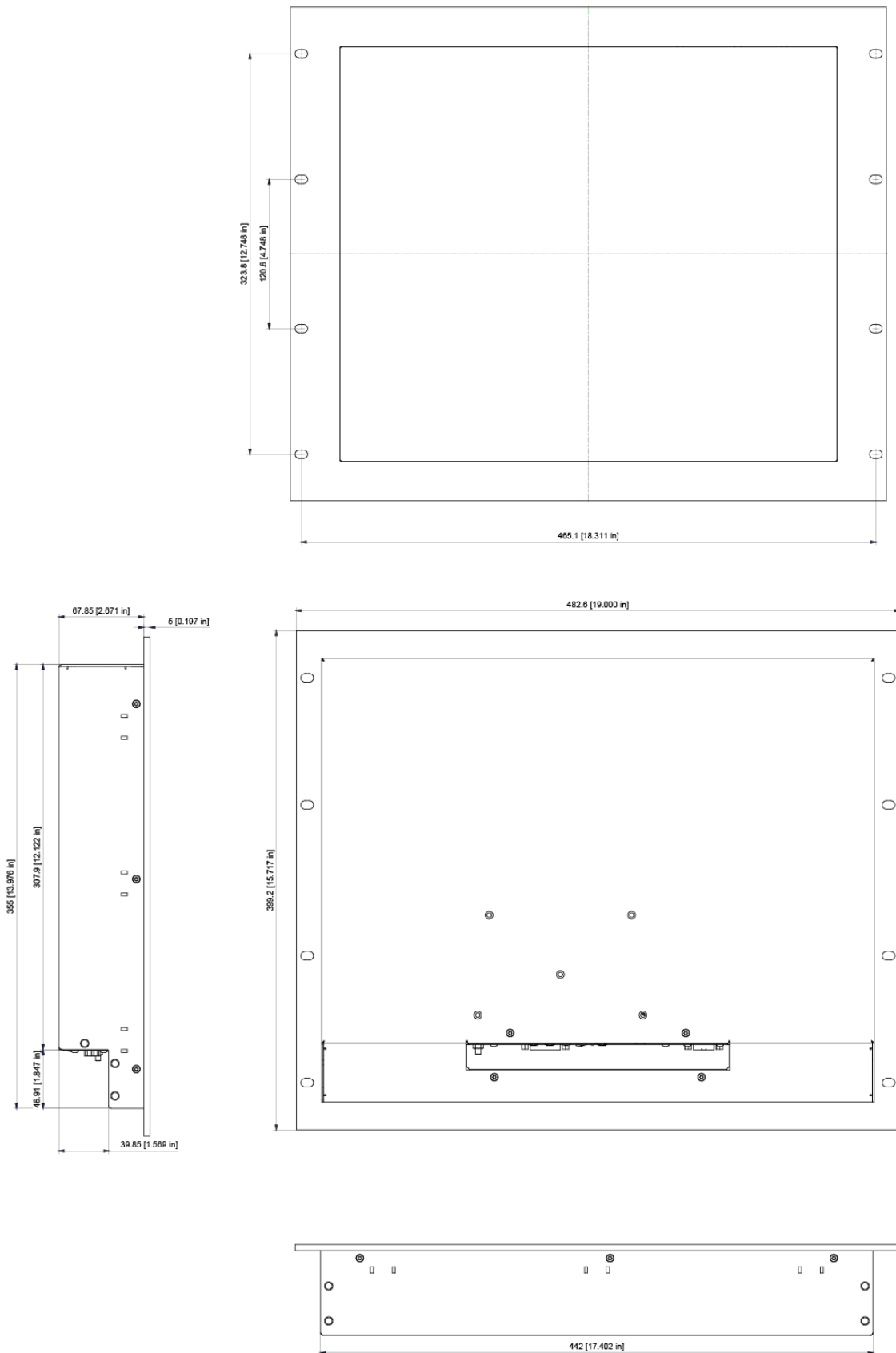

## 7.9. 21.5" Mechanical Dimensions

### 7.9.1. 21.5" Monitor Built-in (slim)

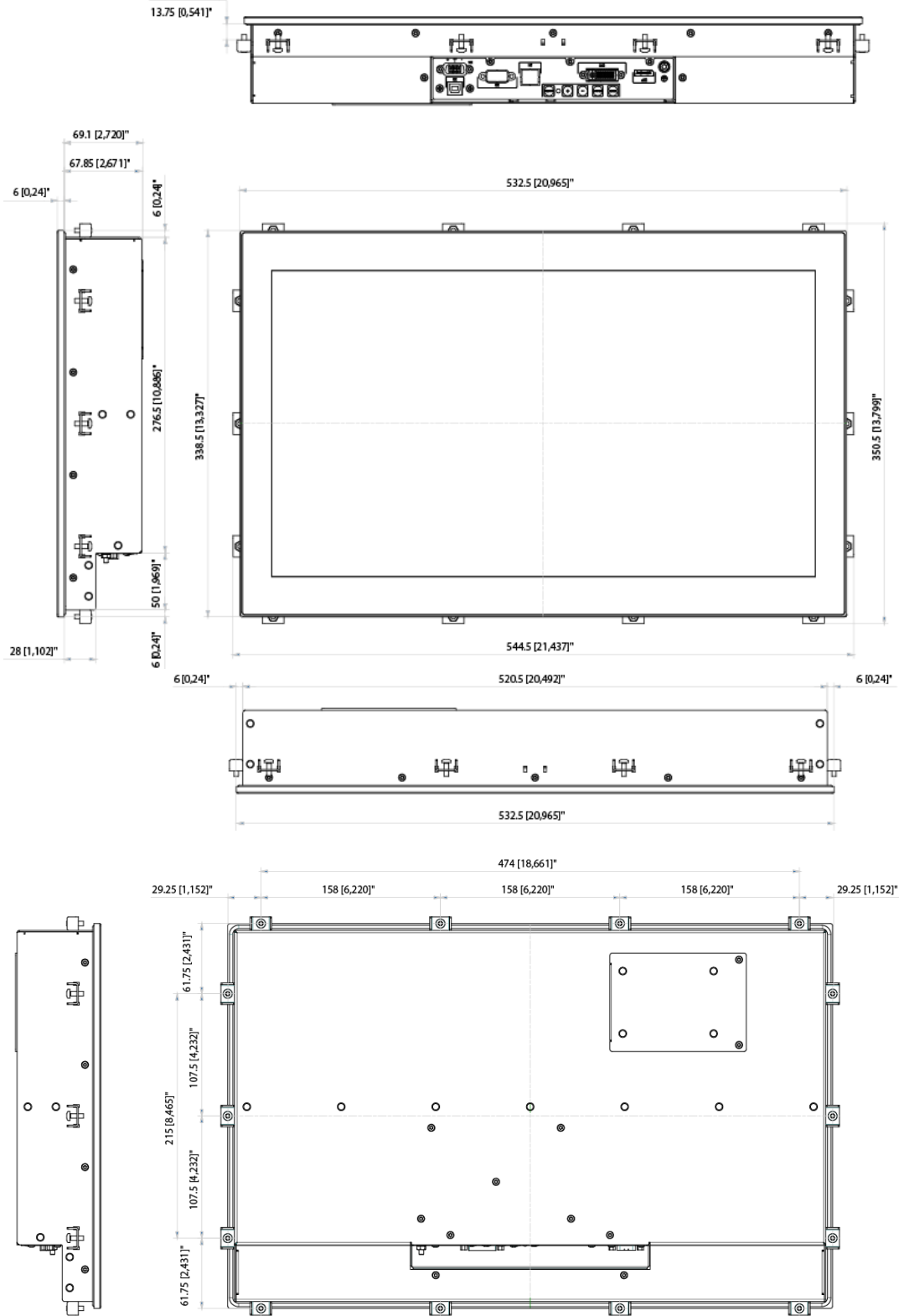

### 7.9.1.1. 21.5" (slim) Panel Cutout Dimensions

The built-in monitor's panel cutout dimensions are:

- ▶ Horizontal: 522.5 mm [20.571"]
- ▶ Vertical: 328.5 mm [12.579"]

### 7.9.2. 21.5 Monitor VESA (slim)

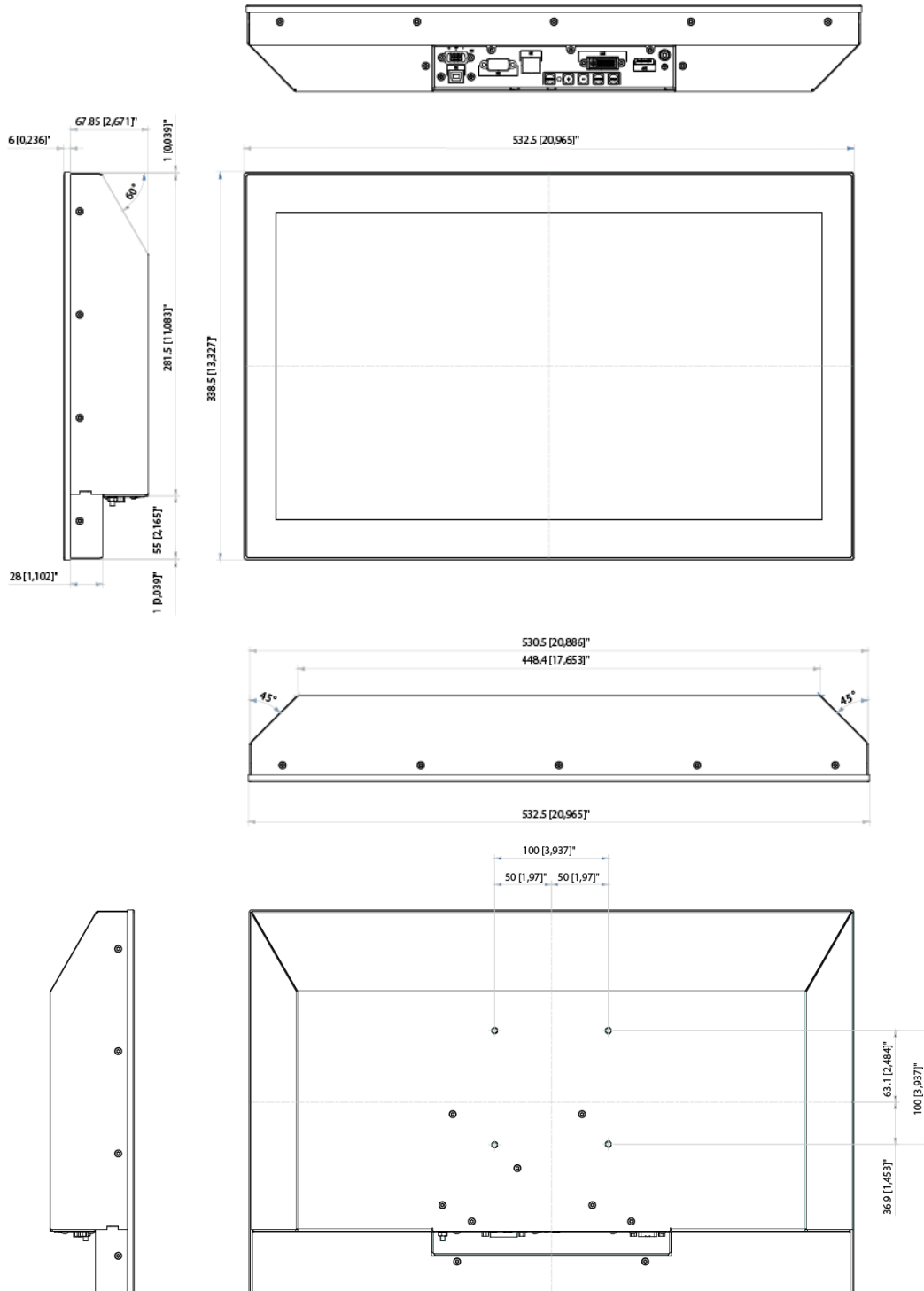

### 7.9.3. 21.5" Monitor Built-in

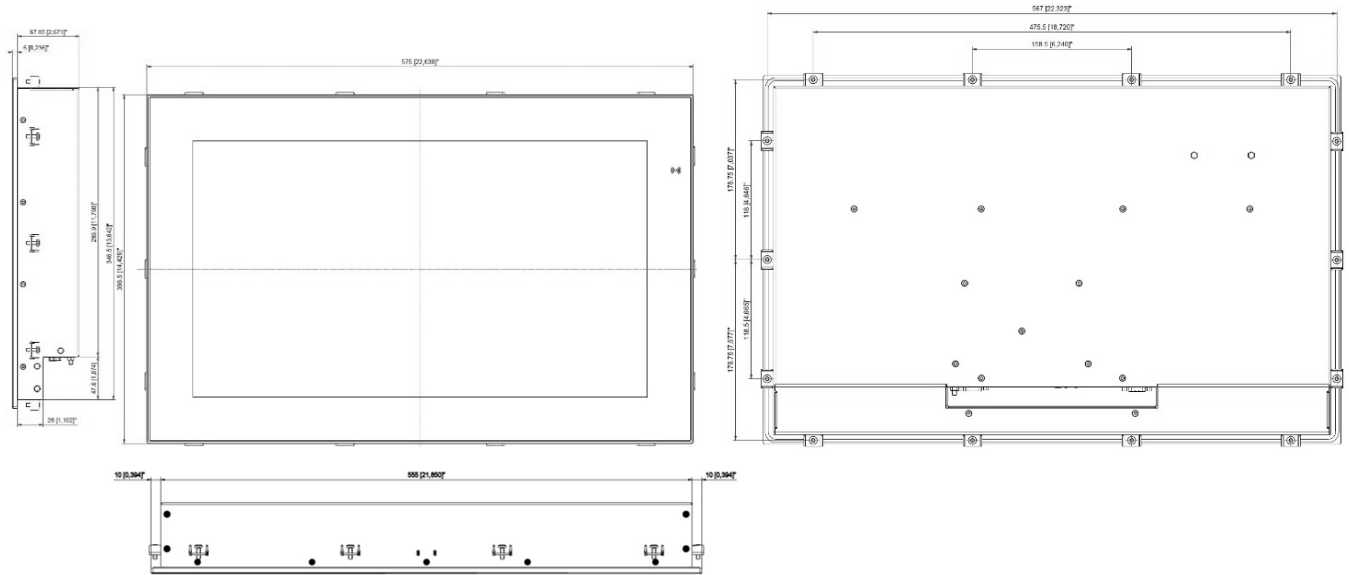

#### 7.9.3.1. 21.5" Panel Cutout Dimensions

The built-in monitor's panel cutout dimensions are:

- ▶ Horizontal: 557 mm [21.929"]
- ▶ Vertical: 348.5 mm [13.720"]

### 7.9.4. 21.5" Monitor VESA

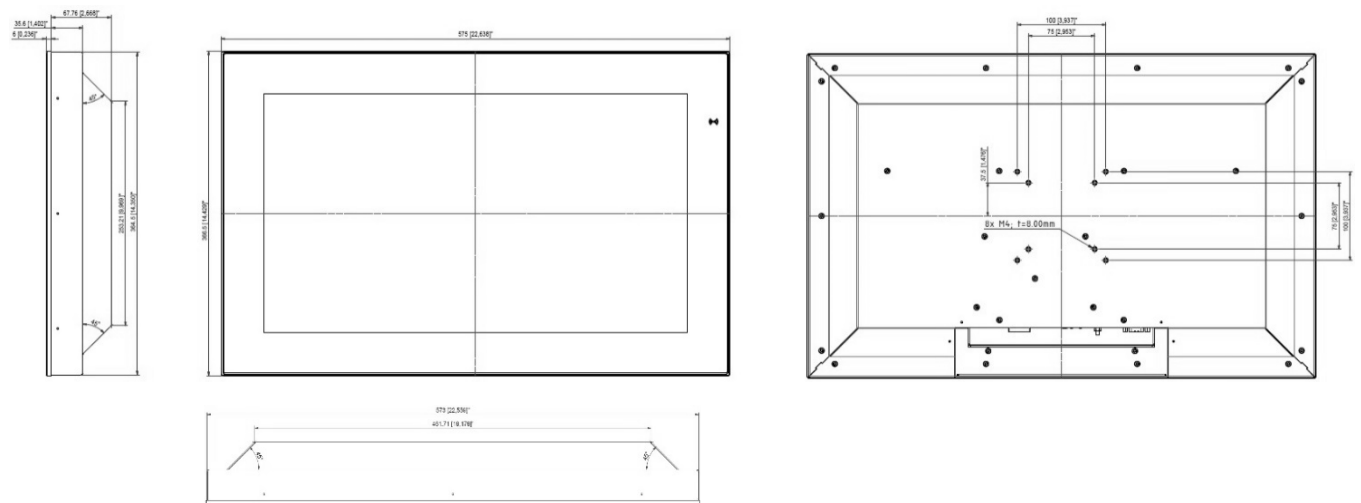

## 7.10. 23.8" Mechanical Dimensions

### 7.10.1. 23.8" Monitor Built-in

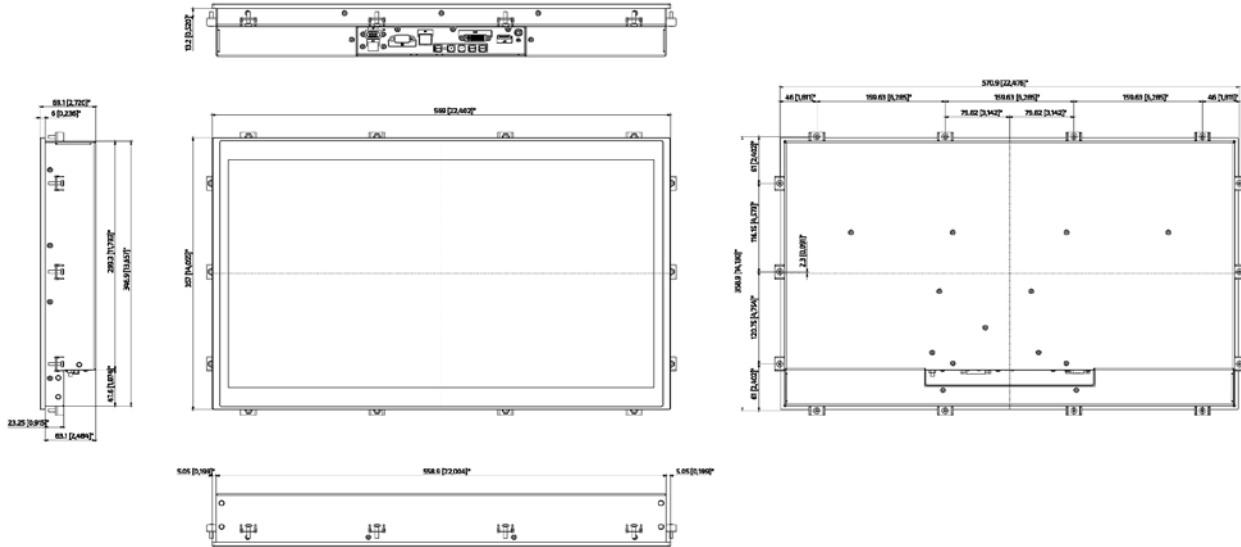

#### 7.10.1.1. 23.8" Panel Cutout Dimensions

The built-in monitor's panel cutout dimensions are:

- ▶ Horizontal: 561 mm [22.087"]
- ▶ Vertical: 348.9 mm [13.740"]

### 7.10.2. 23.8" Monitor VESA

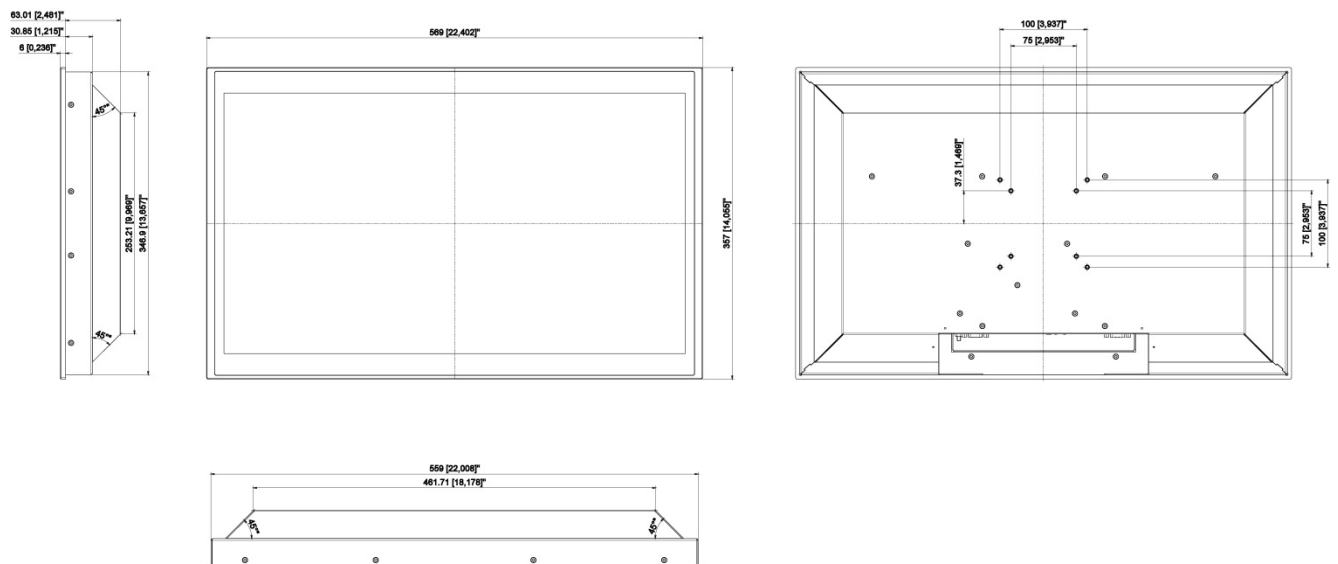



## 8/ Installation and Start

### ⚠ CAUTION

#### Do Not Mount Alone

Due to the weight of the FlatView, mounting alone may result in product damage or personal injury.

### NOTICE

FlatView should be mounted in the vertical position  $\pm 25^\circ$ . Keep a clear distance all around the product of 50 mm. Make sure sufficient ventilation is provided and no other devices heat up the FlatView.

### NOTICE

FlatView is intended for indoor use only. To avoid product damage do not use in a sheltered outdoor, outdoor or sunlit environment.

Observe that the product is not exposed to direct sunlight (UV radiation):

- Prolonged exposure shortens field life and voids the warranty
- Short exposure may lead to higher temperatures inside the product and cause permanent damage
- Direct exposure accelerates long-term aging

For intend use in an outdoor environment or a sunlit environment, contact your Kontron representative.

### NOTICE

Handle with care to avoid damage to the front display screen.

### 8.1. Mounting Instructions Built-in

To mount the FlatView (built-in) and FlatView STS in a panel follow the steps below:

1. Create the cutout required to mount in the panel by referring to the panel cutout dimensions for the corresponding display size in Chapter 7/Mechanical .
2. Make sure the panels mounting surface is clean, smooth and meets the thickness requirements of 3 mm to 7 mm.
3. Use the clamping bracket and screws (Figure 9) provided in the delivered Mounting Set (Table 2: Scope of Delivery) . The number of clamping brackets and screw depends on the display size.

Figure 9: Mounting Set with Clamping Brackets and Screws



The screws provided in the Mounting Set are lens head screw Philips M4x12, DIN 7985 - ISO 7045. Use the correct Philips head screwdriver to fasten the screws.

4. Insert the screw into the clamping bracket in the direction shown in Figure 10: Clamping Bracket with Screw.

Figure 10: Clamping Bracket with Screw



5. Insert the clamping bracket in the housing, as shown in Figure 11: Clamping Bracket Insertion.

Figure 11: Clamping Bracket Insertion



6. Fasten the screw, to fix the clamping bracket to the housing, as shown in Figure 12: Fastening the Clamping Bracket. The recommended tightening torque is 0,8Nm +/-0,2Nm.

---

**NOTICE**

Do not use force when fastening the screw to fix the clamp. Too much force may cause damage. The recommended torque to fasten the screw is 0,8Nm +/-0,2Nm.

---

Figure 12: Fastening the Clamping Bracket



7. Repeat step 4 for all delivered clamping brackets, see Figure 13: Clamping Bracket Positions. The number of clamping brackets depends on the display size.

Figure 13: Clamping Bracket Positions

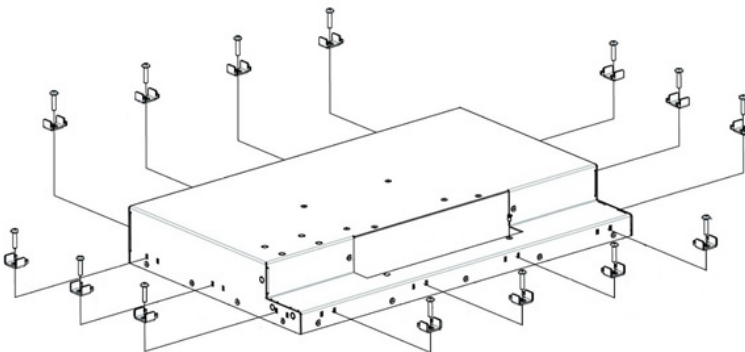

---

**CAUTION**
**Verify Secure Mounting**

Always use all the clamping brackets and screws provided in the Mounting Set delivered with the FlatView and mount on a mounting surface 3 mm to 7 mm thick.

---

## 8.2. Mounting Instructions VESA

To mount the FlatView (VESA) use always all four VESA pattern (75/75 mm or 100/100 mm) M4 threaded holes. Do not use screws longer than 8 mm.

## 8.3. Mounting Instructions Rack

---

**⚠ WARNING**

The 19" rack must be stable. To improve stability:

- Install products from the bottom up
  - Place heavy products lower down
  - Bolt the rack to the floor or anchor the rack to the wall
- 

**⚠ CAUTION**

Verify Secure Installation

To ensure a secure installation that supports the product's weight use all screw holes provided on the right and left sides of the 19" rackmount frame.

---

To mount the FlatView RCK in a 19" industrial rack, perform the following:

1. Fasten the FlatView RCK using all the mounting hole provided on the left and right sides of the frame.
2. Take care not to over tighten the screws and check that the FlatView RCK is securely mounted.

## 8.4. Startup Procedure

Before connecting the FlatView to a power supply, observe the General Safety Instructions within this user guide and the instructions within this chapter, and ensure that the power supply complies with the product's electrical specification, on the Type Label.

The FlatView starts automatically when connected to power and restarts automatically when power returns after an interruption.

### ⚠ CAUTION

Do not switch on or handle the product if there is any visible damage.

Only connect the product to an external power supply providing the voltage type (AC or DC) and the input power (max. current) specified on the Kontron Product Label.

The external power supply must meet the requirements of ES1/PS2 according to IEC/UL 62368-1.

### ⚠ CAUTION

Connectez le produit uniquement à une alimentation externe fournissant le type de tension (AC ou DC) et la puissance d'entrée (courant max.) spécifiés sur l'étiquette du produit Kontron. L'alimentation externe doit répondre aux exigences de ES1/PS2 selon IEC/UL 62368-1.

### ⚠ CAUTION

Switching off the product by its power button does not disconnect it from the mains. Complete disconnection is only possible if the power cable is removed from the wall plug or from the product. Ensure that there is free and easy access to enable disconnection.

### NOTICE

To protect the product and any connected peripherals, make sure that the power cables have the right diameter to withstand the maximum available current.

### NOTICE

Support the power and I/O cables to minimize the strain on the connectors.

### NOTICE

The last cable to be connected must always be the power cable.



All essential drivers are available in Kontron Customer section, visit [Customer Section | Kontron Europe and Asia](#).

### 8.4.1. Connecting to a Power Supply

To connect the FlatView to the Kontron AC/DC power supply with Phoenix mating connector and power cord, perform the following:

1. Connect to the power supply to the power connector (Figure 4, pos. 7, Figure 6, pos. 9 and Figure 8, pos. 9), using the Phoenix connector. Pay attention to the polarity of the connections.
2. Connect the regional power cord to the mains power source.
3. When connected to power, the FlatView starts automatically and the LED "PWR" illuminates.

To connect the FlatView to an external 24 VDC power supply, perform the following:

1. Wire the Phoenix mating power connector with an appropriately wired power cable as described in Chapter 8.4.2: Wiring the Mating Power Connector.
2. Switch off the external DC power supply via a disconnecting device (fuse/circuit breaker), to ensure that no power flows during the connection procedure.
3. Connect the wired mating power connector to the power connector on the FlatView's rear panel; see Figure 4, pos. 7, Figure 6, pos. 9 and Figure 8, pos. 9. Pay attention to the polarity of the connections.
4. Connect the other end of the wired mating power connector cable to the external 24 VDC power supply and switch on the external 24 VDC power supply.
5. When connected to power, the FlatView starts automatically and the power indicator LED illuminates.

### NOTICE

The wires used for power connections must be marked clearly (+/-/functional earth) to ensure a safe connection from the input power connector to the DC power supply.

## 8.4.2. Wiring the Mating Power Connector

The wires must be clearly marked (+/-/functional earth) to ensure proper connection to the DC power supply.

Figure 14: Mating Power Connector

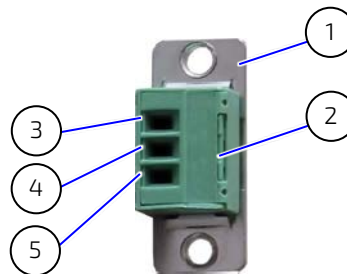

- |   |                                        |   |                        |
|---|----------------------------------------|---|------------------------|
| 1 | 3-pin mating power connector           | 3 | Clamp for 0 VDC wire   |
| 2 | Cover over the slotted pan head screws | 4 | Clamp for earth wire   |
|   |                                        | 5 | Clamp for +24 VDC wire |

To wire the supplied mating power connector, perform the following:

1. Cut three (1 mm<sup>2</sup>) AWG18 isolated wires to the required length and strip each end 5 mm – 7 mm.
2. Twist the striped wire-ends and provide them with ferrules.
3. Access the slotted pan head screws by opening the mating power connector's cover (Figure 14, pos. 2).
4. Loosen the slotted pan head screws far enough so that you can insert the end of the prepared wires.
5. Insert the wires into the corresponding clamp of the mating power connector. Pay attention to the polarity of the connections.
6. Fasten the screws to secure the wires into the mating power connector's clamps.
7. Close the mating power connector's cover (Figure 14, pos. 2).

### NOTICE

Mark the wires clearly as (+/-/functional earth) to ensure a safe connection from the input power connector to the DC power supply.

### 8.4.3. Switch On and Off

Once connected to power, switch off or switch on the FlatView using the power button on the rear panel's OSD keypad, see Figure 16.

The power LED illuminates or is off to indicate the current power state, see Chapter .10.1.2: Power LED.

---

**⚠ CAUTION**

Switching off the product by its power button does not disconnect it from the mains. Complete disconnection is only possible if the power cable is removed from the wall plug or from the product. Ensure that there is free and easy access to enable disconnection.

---

## 9/ Connectors

Figure 15: FlatView Connector Panel

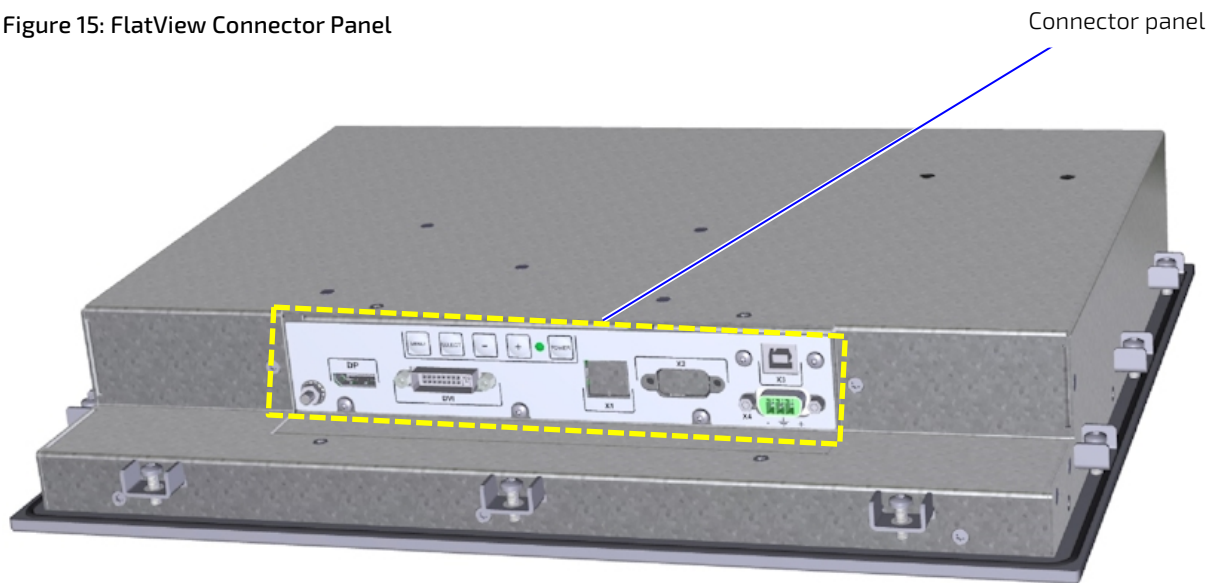

### 9.1. Input Power Connector (PWR)

The 3-pin input power connector connects to an appropriate power supply using the corresponding Phoenix power connector, see the list of accessories, Table 3: List of Accessories.

Table 8: Input Power Connector Pinout

	Pin	Signal
	1	GND
	2	Shield
	3	VCC (24 VDC only)

#### Mating Connector

	Mating Connector Description
	Phoenix mating power connector (PSC 1,5/ 3-F) in DSUB 9 housing

#### ⚠ CAUTION

Only connect the product to an external power supply providing the voltage type (AC or DC) and the input power (max. current) specified on the Kontron Product Label.

The external power supply must meet the requirements of ES1/PS2 according to IEC/UL 62368-1.

Connectez le produit uniquement à une alimentation externe fournissant le type de tension (AC ou DC) et la puissance d'entrée (courant max.) spécifiés sur l'étiquette du produit Kontron. L'alimentation externe doit répondre aux exigences de ES1/PS2 selon IEC/UL 62368-1.

## 9.2. DVI Connector

Table 9: DVI Connector Pinout

Pin	Signal	Pin	Signal	Pin	Signal
2	Rx2+	10	Rx1+	18	Rx0+
3	GND	11	GND	19	GND
4	NC	12	NC	20	NC
5	NC	13	NC	21	NC
6	SCL	14	+5V	22	GND
7	SDA	15	GND	23	RxC+
8	NC	16	HP	24	RxC-
C1	RED	C3	BLUE	C5	GND
C2	GREEN	C4	HSYNC	C5-	GND

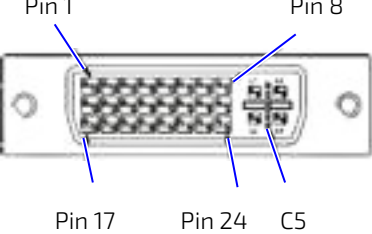

## 9.3. Display Port (DP) Connector

Table 10: DP Connector Pinout

Pin	Signal	Pin	Signal
1	TX0+	11	GND
2	GND	12	TX3-
3	TX0-	13	GND
4	TX1+	14	GND
5	GND	15	AUX+
6	TX1-	16	GND
7	TX2+	17	AUX-
8	GND	18	HPD
9	TX2-	19	GND
10	TX3+	20	PWR

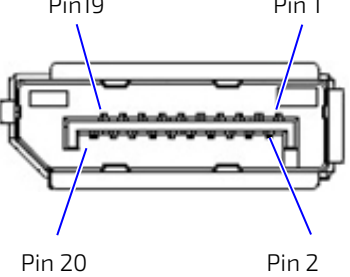

## 9.4. USB Port (Type B)

.Connect the USB port to a PC using Kontron's USB type A/Type B cable, see Table 3: List of Accessories

Table 11: USB Port Pinout

Pin	Signal
1	+USB_VCC
2	USB_D-
3	USB_D+
4	GND

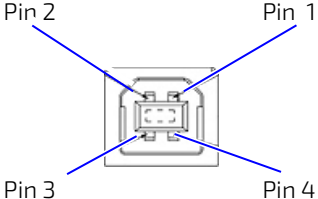

The USB port is internally connected to the touch controller.



## 10/ OSD (On Screen Display)

### 10.1. OSD Keypad

Figure 16: OSD Keys



With the self-explanatory OSD, it is possible to modify the settings and control the CRTtoLCD-Controller's special features. The OSD uses a number of menus to make changes and switch on or switch off special features. The configuration can be performed via the OSD-keypad.

#### 10.1.1. Power Button



To switch on or switch off the power, press the POWER button.

#### 10.1.2. Power LED

The Power LED indicates the current power state.

Table 12: LED Power Indicator's Color Description

LED	Function
Off	No Power
Green	Active
Yellow	Standby

#### 10.1.3. Menu Button

To open the OSD menu, press the MENU button.

### 10.1.4. Select Button



To select an item in the OSD menu (Main Menu or Sub Menus), press the SELECT button.

When a picture is shown, pressing the SELECT button once displays the Brightness.



Pressing the select button twice displays the Contrast.



Pressing the SELECT button a third time displays the Backlight.

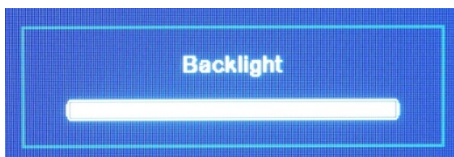

When connected to a VGA input and the SELECT button is pressed after Phase, Hor. Position and Ver. Position are displayed in sequence after backlight.



## 10.1.5. Up and Down Button

To move up and down an OSD menu (Main Menu or Sub Menu), use the UP (+) or DOWN (-) button to move the cursor.

When a DP/DVI is connected, pressing the (+) button initiates an ISP pattern search and displays:



Once the ISP pattern has been located, the following is displayed.



---

Prerequisite is that the signal is connected to a digital display input (DVI or DP).

---

## 10.2. OSD Menu

The OSD main menu settings are located on the left side of the display screen. If selected, the main menu setting is highlighted in a black box and the related sub menu items are shown in the display screen's center. If a sub menu item is selected and highlighted in a black box and the sub menu's options are shown on display screen' right side.

### 10.2.1. Main Menu: Input Select

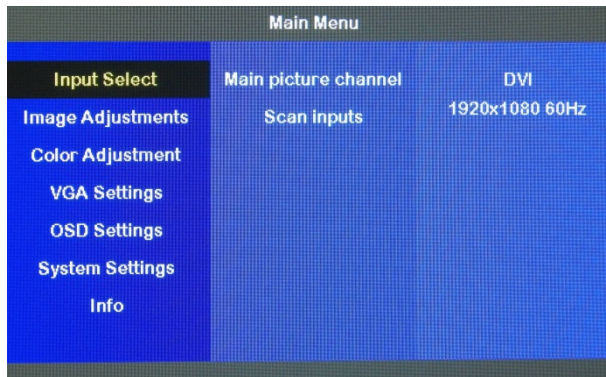

#### 10.2.1.1. Sub Menu: Main Picture Channel

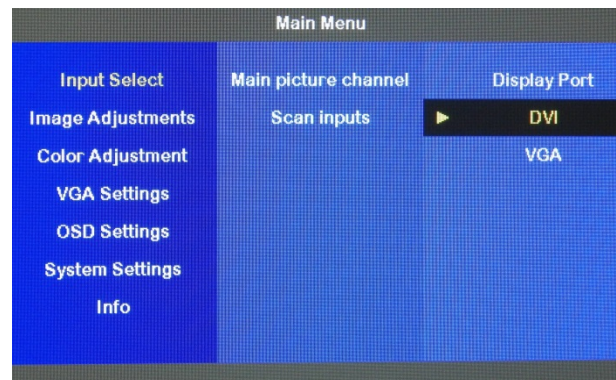
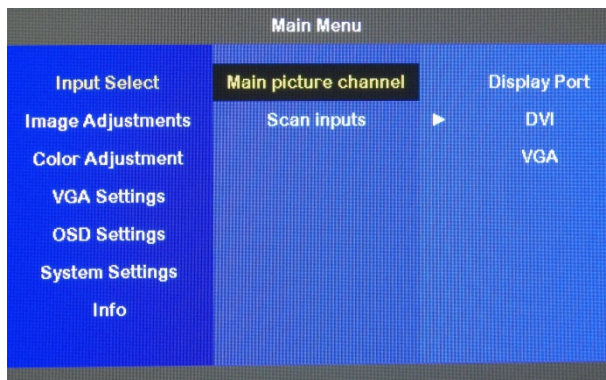



---

The digital (DP and DVI) and analog (VGA) settings may differ.

---

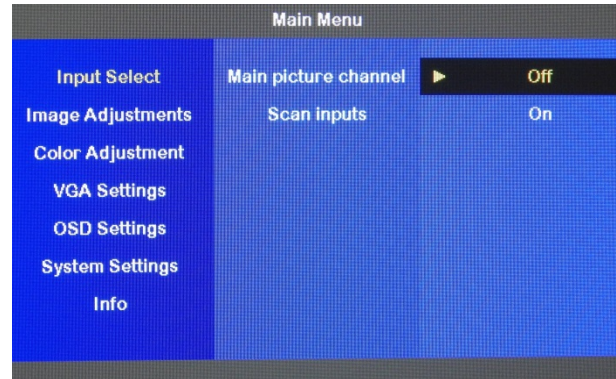
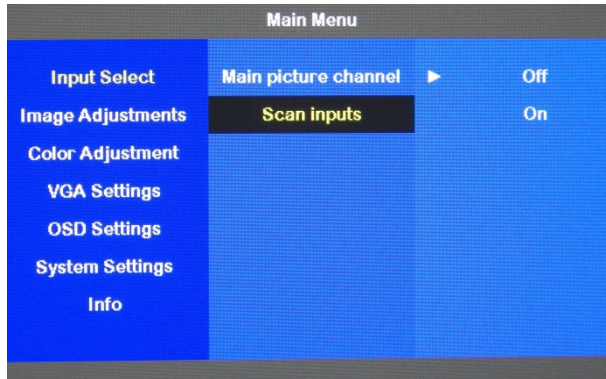
### 10.2.1.2. Sub Menu: Scan Inputs



For Scan Input ACTIVE

OSD Sub-Menu	Description
Input Select > Scan Inputs > On	If the signal is lost, all inputs are scanned for an input signal. Note: It is not possible to switch to a defined input signal.

For Smart Scan ACTIVE

OSD Sub-Menu	Description
Input Select > Scan Inputs > Off	If the Input signal is found, the following is displayed: <b>Input Select -&gt;Scan inputs &gt; Off</b>
Input Select > Scan inputs > On	If the Input signal is not found, the following is displayed: <b>Input Select -&gt;Scan inputs &gt; On</b>

### 10.2.2. Main Menu: Image Adjustments

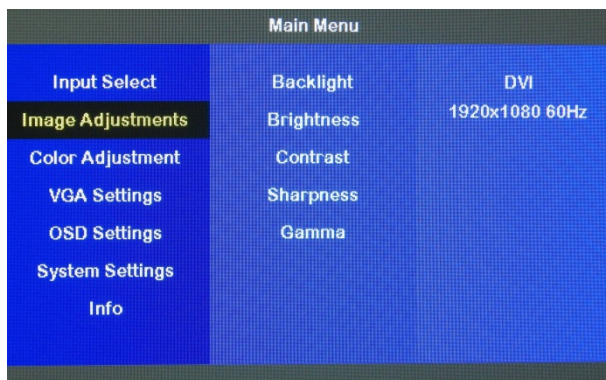

### 10.2.2.1. Sub Menu: Backlight

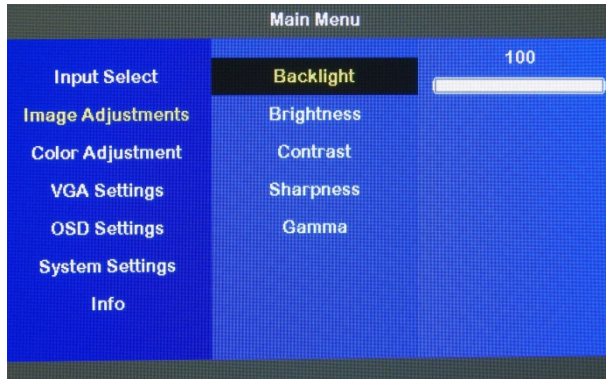

### 10.2.2.2. Sub Menu: Brightness

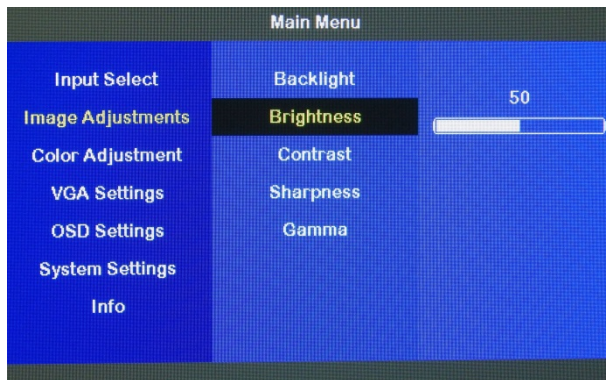

### 10.2.2.3. Sub Menu: Contrast

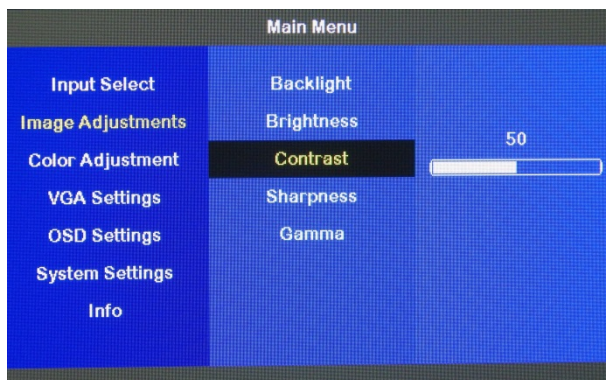

### 10.2.2.4. Sub Menu: Sharpness

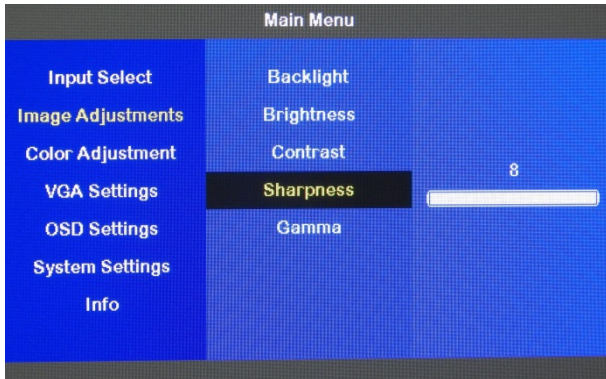

### 10.2.2.5. Sub Menu: Gamma

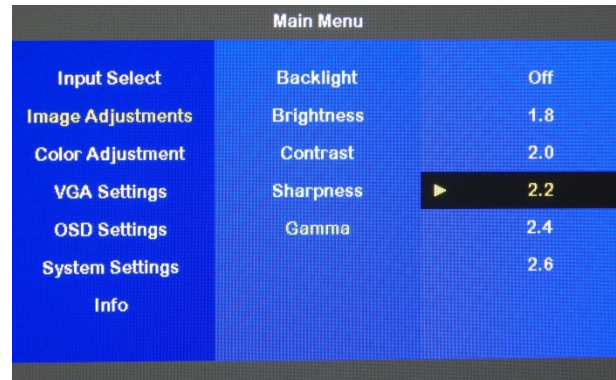
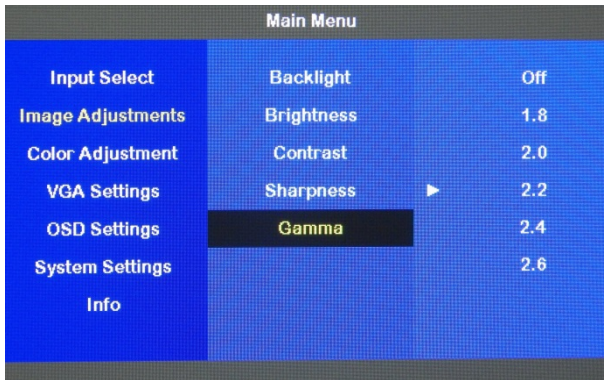

### 10.2.3. Main Menu: Color Adjustment

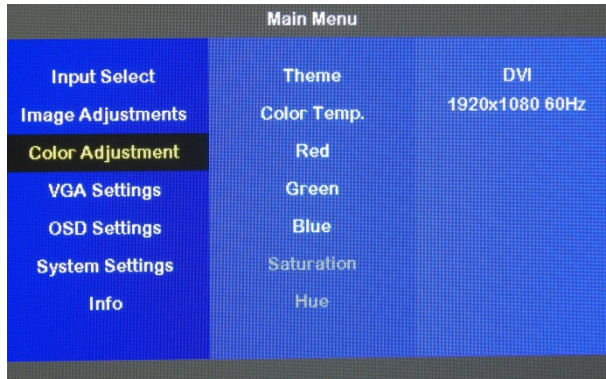

#### 10.2.3.1. Sub Menu: Theme

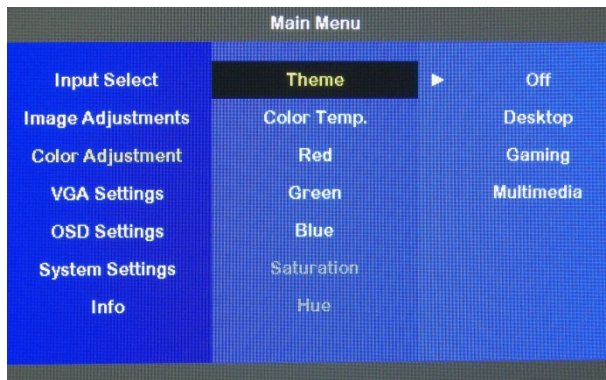

#### 10.2.3.2. Sub Menu: Color Temp.

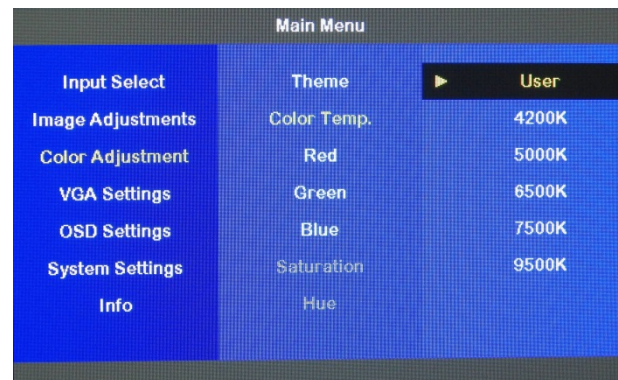
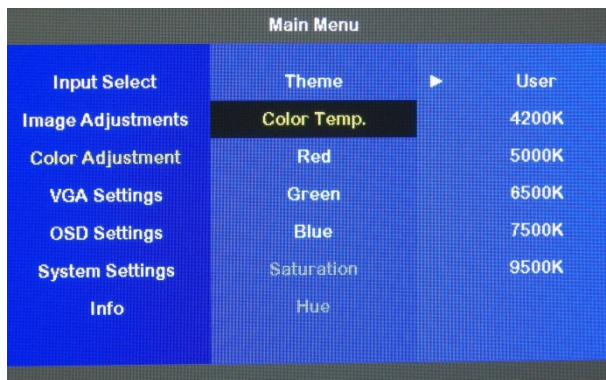

If 'Color Adjustment > Color Temp. > User' is selected the Sub Menu items Red/Green/Blue are active to select.



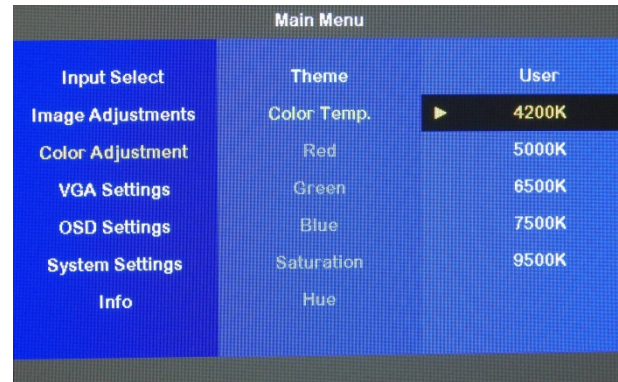
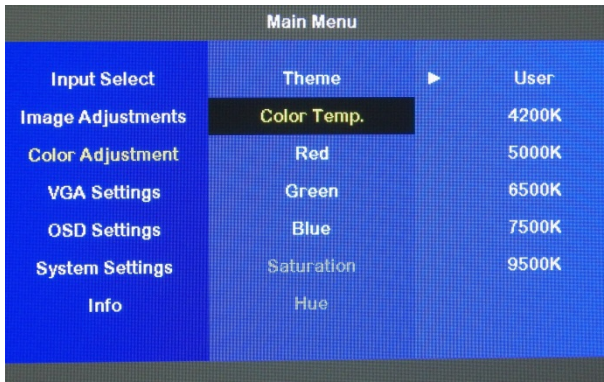

If 'Color Adjustment > Color Temp. > 4200K/5000K/6500K/7500K/9500K' are selected, the Sub Menu items Red/Green/Blue and are not active to select.

### 10.2.3.3. Sub Menu: Red

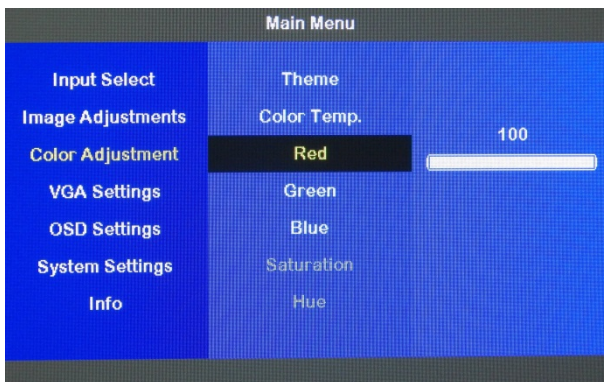

### 10.2.3.4. Sub Menu: Green

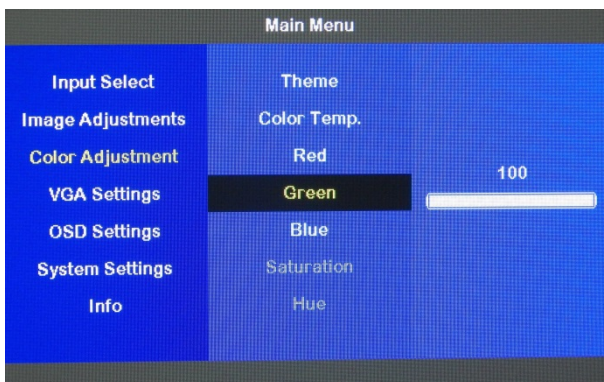

### 10.2.3.5. Sub Menu: Blue

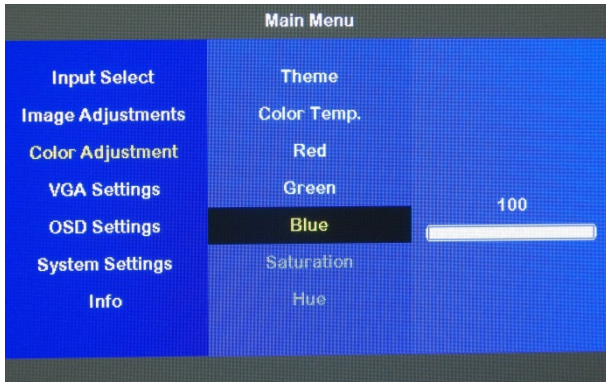

### 10.2.3.6. Sub Menu: Saturation

Not active to select.

### 10.2.3.7. Sub Menu: Hue

Not active to select.

### 10.2.4. Main Menu: VGA Settings

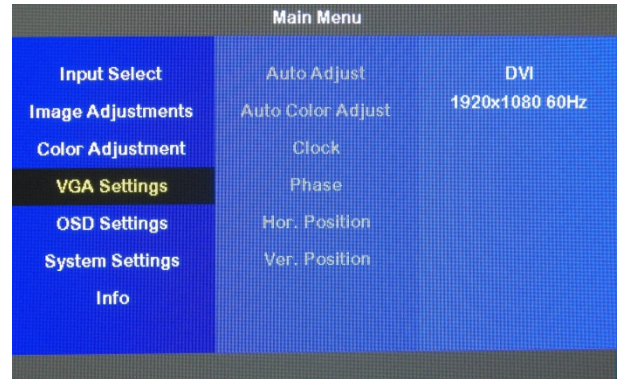
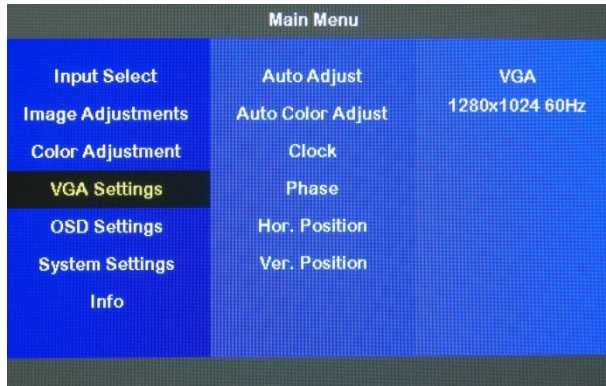

When connected via VGA the Sub Menu items are selectable. When connected via DVI/DP the Sub Menu items cannot be selected.

#### 10.2.4.1. Sub Menu: Auto Adjust

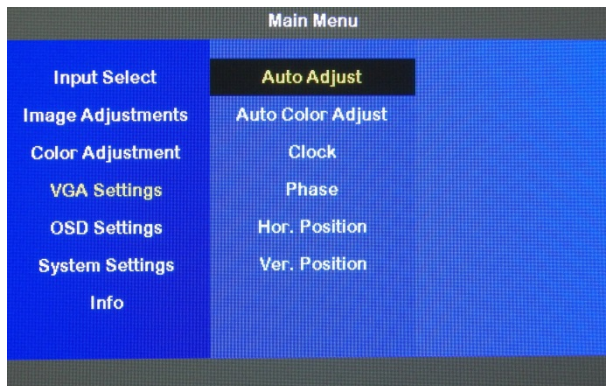

#### 10.2.4.2. Sub Menu: Auto Color Adjust

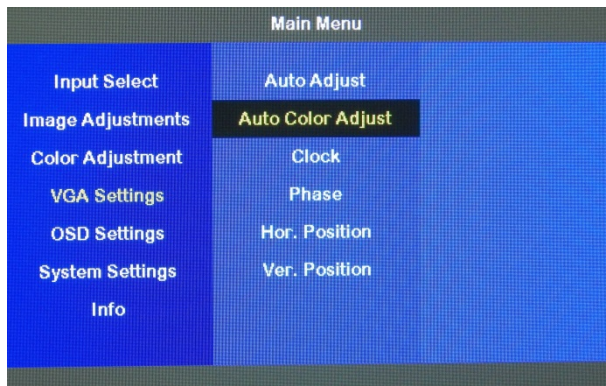

### 10.2.4.3. Sub Menu: Clock

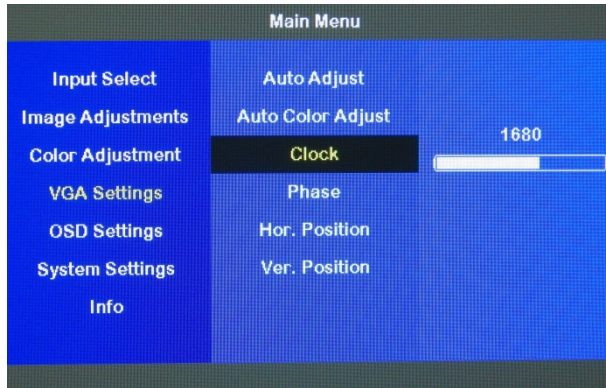

### 10.2.4.4. Sub Menu: Phase

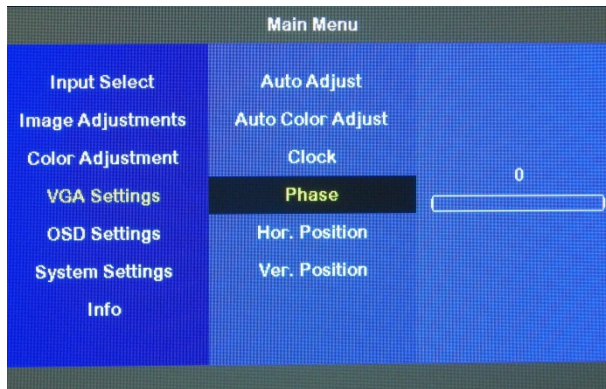

### 10.2.4.5. Sub Menu: Hor. Position

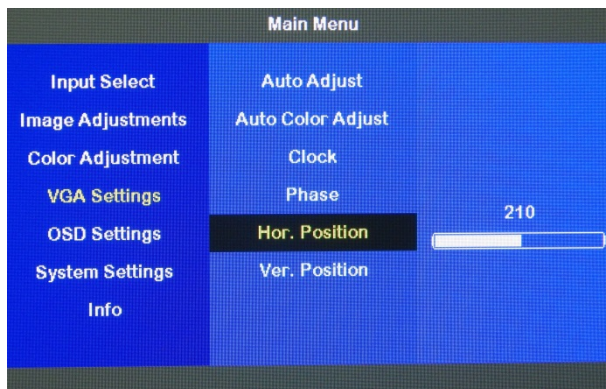

### 10.2.4.6. Sub Menu: Ver. Position

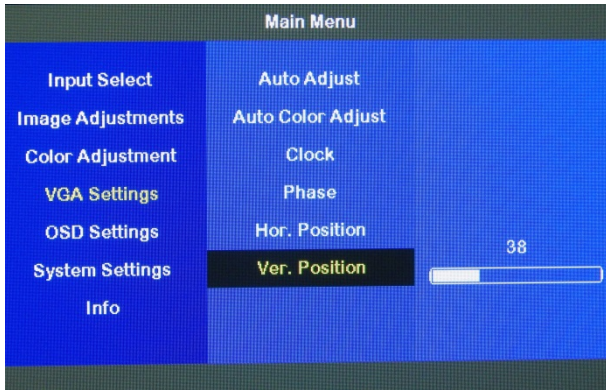

### 10.2.5. Main Menu: OSD Settings

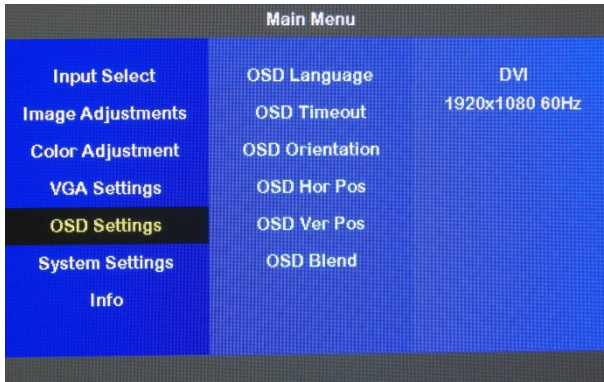

#### 10.2.5.1. Sub Menu: OSD Language

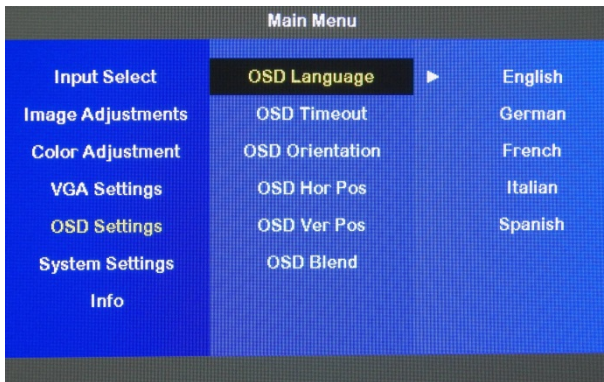

#### 10.2.5.2. Sub Menu: OSD Timeout

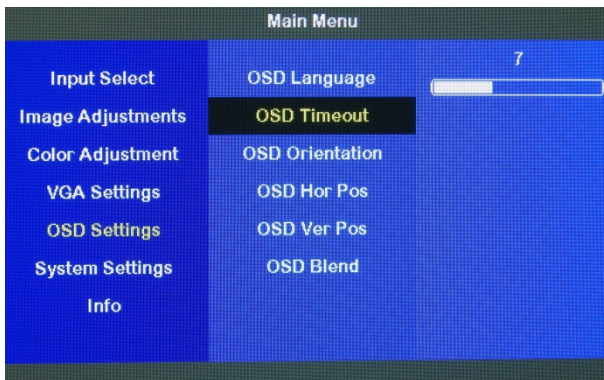

### 10.2.5.3. Sub Menu: OSD Orientation

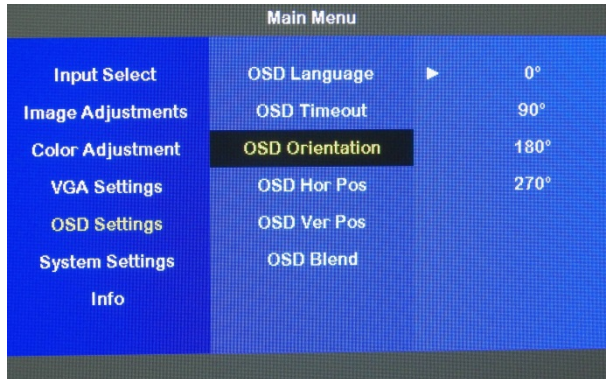

### 10.2.5.4. Sub Menu: OSD Hor. Pos.

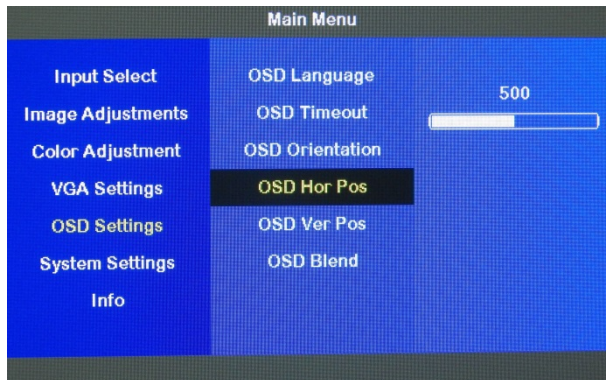

### 10.2.5.5. Sub Menu: OSD Ver. Pos.

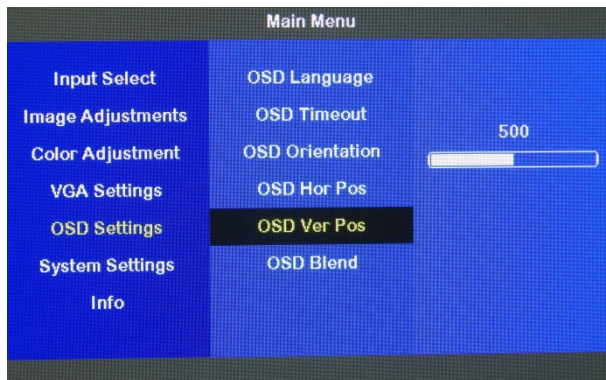

### 10.2.5.6. Sub Menu: OSD Blend

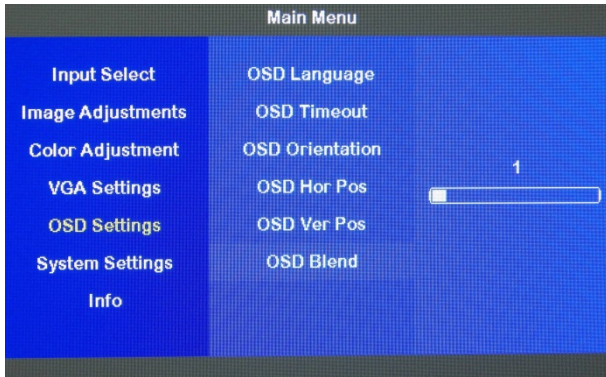



## 10.2.6. Main Menu: System Settings

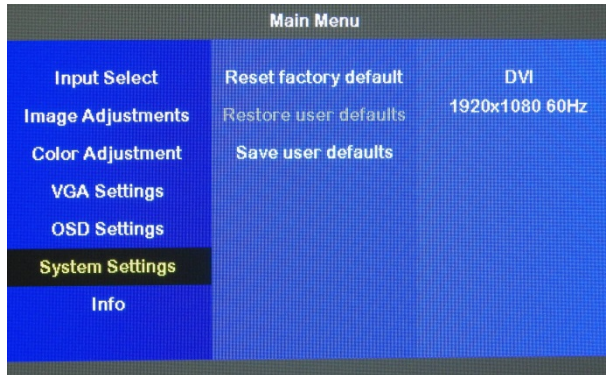

### 10.2.6.1. Sub Menu: Reset Factory Default

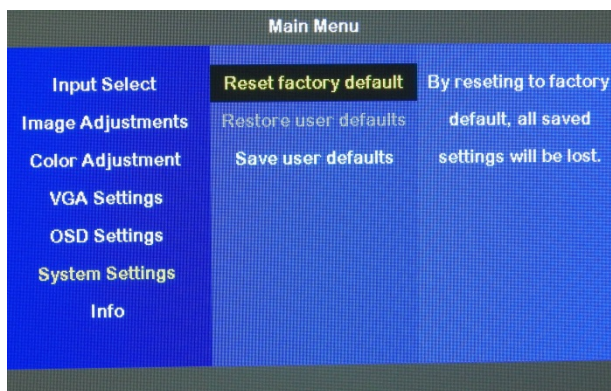

### 10.2.6.2. Sub Menu: Restore user defaults

Not active to select.

### 10.2.6.3. Sub Menu: Save user defaults

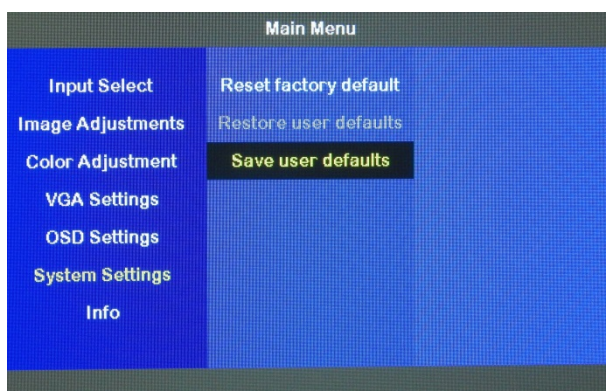

### 10.2.7. Main Menu: Info

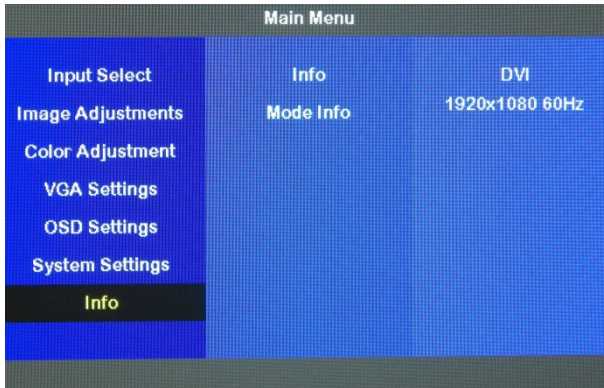

#### 10.2.7.1. Sub Menu: Info

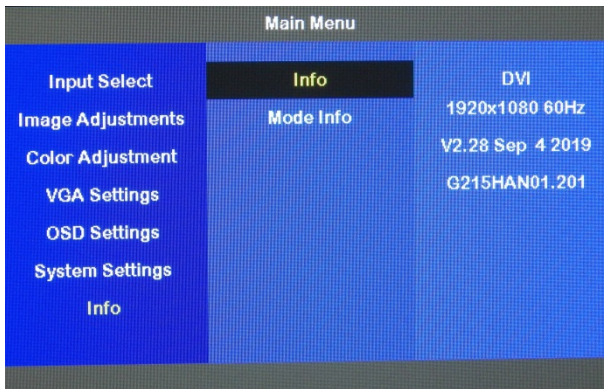

#### 10.2.7.2. Sub Menu: Mode Info

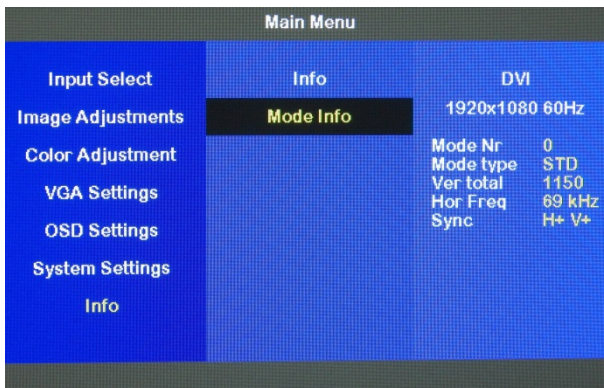

## 11/Technical Support

For technical support contact our Support Department:

- ▶ E-mail: support@kontron.com
- ▶ Phone: +49-821-4086-888

Make sure you have the following information available when you call:

- ▶ Product ID Number (PN),
- ▶ Serial Number (SN)



---

The serial number can be found on the Type Label, located on the product's rear panel.

---

Be ready to explain the nature of your problem to the service technician.

### 11.1. Returning Defective Merchandise

All equipment returned to Kontron must have a Return of Material Authorization (RMA) number assigned exclusively by Kontron. Kontron cannot be held responsible for any loss or damage caused to the equipment received without an RMA number. The buyer accepts responsibility for all freight charges for the return of goods to Kontron's designated facility. Kontron will pay the return freight charges back to the buyer's location in the event that the equipment is repaired or replaced within the stipulated warranty period.

Follow these steps before returning any product to Kontron.

1. Visit the RMA Information website: <http://www.kontron.com/support-and-services/support/rma-information>
2. Download the RMA Request sheet for **Kontron Europe GmbH – Ismaning** and fill out the form. Take care to include a short detailed description of the observed problem or failure and to include the product identification Information (Name of product, Product number and Serial number). If a delivery includes more than one product, fill out the above information in the RMA Request form for each product.  
Send the completed RMA-Request form to the fax or email address given on the RMA Request sheet and Kontron will provide an RMA-Number.
3. The goods for repair must be packed properly for shipping, considering shock and ESD protection.
4. Include the RMA-Number with the shipping paperwork and send the product to the delivery address provided in the RMA form or received from Kontron RMA Support.



---

Goods returned to Kontron in non-proper packaging will be considered as customer caused faults and cannot be accepted as warranty repairs.

---

## 12/ Storage, Transportation and Maintenance

### 12.1. Storage

If the product is not in use for an extended period time, disconnect the power plug from the power supply. If it is necessary to store the product then re-pack the product as originally delivered to avoid damage. The storage facility must meet the products environmental storage requirements as stated within this user guide. Kontron recommends keeping the original packaging material for future storage or warranty shipments.

### 12.2. Transportation

To ship the product use the original packaging, designed to withstand impact and adequately protect the product. When packing or unpacking products always take shock and ESD protection into consideration and use an EOS/ESD safe working area.

### 12.3. Maintenance

The FlatView contains no user serviceable parts. To return the FlatView for maintenance and repair, see Chapter **Error! Reference source not found.: Error! Reference source not found.**

---

**CAUTION**

There are no customer serviceable parts. If problems of a technical nature occur, contact [Kontron Support](#) or return for repair.

---

### 12.4. Cleaning the Display

When cleaning the display:

- ▶ Use a clean soft microfiber cloth.
- ▶ Use a commercially available glass cleaner or Ethanol Alcohol.
- ▶ Gently wipe the display with a cloth dampened with the glass cleaner.
- ▶ Do not press on the display when cleaning.

---

**NOTICE**

When cleaning the display, do not apply any pressure or use an abrasive substance/cloth that might scratch or damage the display's surface.

---

## 13/ Warranty

Kontron defines product warranty in accordance with regional warranty definitions. Claims are at Kontron's discretion and limited to the defect being of a material nature. To find out more about the warranty conditions and the defined warranty period for your region, following the steps below:

1. Visit Kontron's Term and Conditions webpage.  
<http://www.kontron.com/terms-and-conditions>
2. Click on your region's General Terms and Conditions of Sale.

### 13.1. Limitation/Exemption from Warranty Obligation

In general, Kontron shall not be required to honor the warranty, even during the warranty period, and shall be exempted from the statutory accident liability obligations in the event of damage caused to the product due to failure to observe the following:

- ▶ General Safety Instructions within this user guide
- ▶ Warning labels on the product and warning symbols within this user guide
- ▶ Information and hints within this user guide

Additionally, alterations or modifications to the product that are not explicitly approved by Kontron, described in this user guide, or received from Kontron Support as a special handling instruction will void your warranty.

Due to their limited service life, parts that by their nature are subject to a particularly high degree of wear (wearing parts) are excluded from the warranty beyond that provided by law. For example, this applies to a CMOS battery.



---

**There is a protection label on your FlatView.  
If the product is opened, the warranty is lost.**

---

## Appendix: List of Acronyms

Table 13: List of Acronyms

AC	Alternating Current
CE	Conformité Européenne
DC	Direct Current
DOS	Desk-Operating-System
DP	Display Port
DVI	Digital Visual Interface
EMC	ElectroMagnetic compatibility
ESD	ElectroStatic Discharge
HD	High definition
IOL	IPMI-Over-LAN
IOT	Internet of Things
LAN	Local Area Network
LED	Light Emitting Diode
LPC	Low Pin Count
OSD	On Screen Display
PCAP	Projected Capacitive Touch Screen
RMA	Return of Material Authorization
RoHS	Restriction of Hazardous Substances
RTC	Real Time Clock
SELV	Safety Extra Low Voltage
SVGA	Super Video Graphics Array
SXGA	Super eXtended Graphics Array
TPM	Trusted Platform Module
UEFI	Unified Extensible Firmware Interface
USB	Universal Serial Bus
UV	Ultra Violet
UXGA	Ultra eXtended Graphics Array
VESA	Video Electronics Standard Association
VGA	Video Graphics Array
VLP	Very Low Profile
WXGA	Wide eXtended Graphics Array



## About Kontron

Kontron is a global leader in Embedded Computing Technology (ECT). As a part of technology group S&T, Kontron offers a combined portfolio of secure hardware, middleware and services for Internet of Things (IoT) and Industry 4.0 applications. With its standard products and tailor-made solutions based on highly reliable state-of-the-art embedded technologies, Kontron provides secure and innovative applications for a variety of industries. As a result, customers benefit from accelerated time-to-market, reduced total cost of ownership, product longevity and the best fully integrated applications overall. For more information, please visit: <http://www.kontron.com/>

---



### GLOBAL HEADQUARTERS

#### KONTRON Europe GmbH

Gutenbergstraße 2  
85737 Ismaning  
Germany  
Tel.: +49 821 4086-0  
Fax: +49 821 4086-111  
[info@kontron.com](mailto:info@kontron.com)