



# KBox A-150-KBL

Doc. User Guide Rev. 1.5

Doc. ID: 1062-3590

This page has been intentionally left blank

 KBOX A-150-KBL - USER GUIDE

## Disclaimer

Kontron would like to point out that the information contained in this user guide may be subject to alteration, particularly as a result of the constant upgrading of Kontron products. This document does not entail any guarantee on the part of Kontron with respect to technical processes described in the user guide or any product characteristics set out in the user guide. Kontron assumes no responsibility or liability for the use of the described product(s), conveys no license or title under any patent, copyright or mask work rights to these products and makes no representations or warranties that these products are free from patent, copyright or mask work right infringement unless otherwise specified. Applications that are described in this user guide are for illustration purposes only. Kontron makes no representation or warranty that such application will be suitable for the specified use without further testing or modification. Kontron expressly informs the user that this user guide only contains a general description of processes and instructions which may not be applicable in every individual case. In cases of doubt, please contact Kontron.

This user guide is protected by copyright. All rights are reserved by Kontron. No part of this document may be reproduced, transmitted, transcribed, stored in a retrieval system, or translated into any language or computer language, in any form or by any means (electronic, mechanical, photocopying, recording, or otherwise), without the express written permission of Kontron. Kontron points out that the information contained in this user guide is constantly being updated in line with the technical alterations and improvements made by Kontron to the products and thus this user guide only reflects the technical status of the products by Kontron at the time of publishing.

Brand and product names are trademarks or registered trademarks of their respective owners.

©2018 by Kontron Europe GmbH

Kontron Europe GmbH

Gutenbergstraße 2  
85737 Ismaning  
Germany  
[www.kontron.com](http://www.kontron.com)

## Intended Use

This DIN rail industrial embedded computer platform, sold by Kontron, is part of Kontron's A-Series intended for control cabinet applications, offering high performance at low power dissipation. The KBox A-150 product family can operate in a temperature range from 0°C to plus 40°C, and a humidity of 10 to 90 percent does not affect the function of the product. The products fanless design ensures a significantly prolonged lifespan and high system availability. This product offers flexible DIN Rail mounting positions within a control cabinet even when space is limited. Users must comply with all product specifications stated in the product documentation and this user guide. If it is intended, to incorporated the product into any total systems or applications, carry out sufficient, compatibility and functions tests prior to any use or resale.

THIS PRODUCT IS NOT DESIGNED, MANUFACTURED OR INTENDED FOR USE OR RESALE FOR THE OPERATION OF APPLICATION IN A HAZARDOUS ENVIRONMENT, OR REQUIRING FAIL-SAFE PERFORMANCE, OR IN WHICH THE FAILURE OF PRODUCTS COULD LEAD DIRECTLY TO DEATH, PERSONAL INJURY, OR SEVERE PHYSICAL OR ENVIRONMENTAL DAMAGE (COLLECTIVELY "HIGH RISK APPLICATIONS").

You understand and agree that your use of Kontron product as a component in High Risk Applications is entirely at your own risk. To minimize the risks associated with your systems and applications, you must provide adequate design and operating safeguards. You are responsible to ensure that your systems (and any Kontron hardware or software products incorporated in your systems) meet all applicable requirements. Unless otherwise stated in the product documentation, the Kontron product is not provided with error-tolerance capabilities and therefore cannot be deemed as being engineered, manufactured or setup to be compliant for implementation or for resale as a component in High Risk Applications. All application and safety related information in this document (including application descriptions, suggested safety measures, suggested Kontron products, and other materials) is provided for reference only.

---

**NOTICE**

You find the most recent version of the "General Safety Instructions" online in the download area of this product.

---

## Revision History

| Revision | Brief Description of Changes  | Date of Issue | Author/Editor |
|----------|---|---------------|---------------|
| 1.0      | Initial version   | 2018-Oct-02   | CW            |
| 1.1      | Update standards, BIOS, block diagram, scope of delivery, accessories, type label, battery info, OS type, internal component pin assignments, and standards certification and directives information. Added heatsink dimensions and keep out area data. | 2019-Sept-27  | CW            |
| 1.2      | Added UEFI BIOS only information in Chapter 12.   | 2020-Feb-06   | CW            |
| 1.3      | Updated general safety instructions and added caution in Special Handling and Unpacking Instruction. Added PSU spec. data and LPS caution and mating power connector/terminal wiring spec.  | 2020-Sept-09  | CW            |
| 1.4      | Updates Figure 4. DSUB serial connectors orientation changed. Renamed Chapter 10.5 Compliance. Updated boiler text, company name and address, and General Safety Instructions. Changed Battery warning in Ch. 1.2 and Ch.14.3.1.                        | 2022-Jan-05   | CW            |
| 1.5      | Replaced Ubuntu with Linux and added new logo   | 2023-Sept-06  | CW            |

## Terms and Conditions

Kontron warrants products in accordance with defined regional warranty periods. For more information about warranty compliance and conformity, and the warranty period in your region, visit <http://www.kontron.com/terms-and-conditions>.

Kontron sells products worldwide and declares regional General Terms & Conditions of Sale, and Purchase Order Terms & Conditions. Visit <http://www.kontron.com/terms-and-conditions>.

For contact information, refer to the corporate offices contact information on the last page of this user guide or visit our website [CONTACT US](#).

## Customer Support

Find Kontron contacts by visiting: <https://www.kontron.com/en/support>.

## Customer Service

As a trusted technology innovator and global solutions provider, Kontron extends its embedded market strengths into a services portfolio allowing companies to break the barriers of traditional product lifecycles. Proven product expertise coupled with collaborative and highly-experienced support enables Kontron to provide exceptional peace of mind to build and maintain successful products.

For more details on Kontron's service offerings such as: enhanced repair services, extended warranty, Kontron training academy, and more visit <https://www.kontron.com/en/service>

## Customer Comments

If you have any difficulties using this user guide, discover an error, or just want to provide some feedback, contact [Kontron Support](#). Detail any errors you find. We will correct the errors or problems as soon as possible and post the revised user guide on our website.

## Symbols

The following symbols may be used in this user guide

### **⚠ DANGER**

DANGER indicates a hazardous situation which, if not avoided, will result in death or serious injury.

### **⚠ WARNING**

WARNING indicates a hazardous situation which, if not avoided, could result in death or serious injury.

### **NOTICE**

NOTICE indicates a property damage message.

### **⚠ CAUTION**

CAUTION indicates a hazardous situation which, if not avoided, may result in minor or moderate injury.



Electric Shock!

This symbol and title warn of hazards due to electrical shocks (> 60 V) when touching products or parts of products. Failure to observe the precautions indicated and/or prescribed by the law may endanger your life/health and/or result in damage to your material.



ESD Sensitive Device!

This symbol and title inform that the electronic boards and their components are sensitive to static electricity. Care must therefore be taken during all handling operations and inspections of this product in order to ensure product integrity at all times.



HOT Surface!

Do NOT touch! Allow to cool before servicing.



Laser!

This symbol informs of the risk of exposure to laser beam and light emitting devices (LEDs) from an electrical device. Eye protection per manufacturer notice shall review before servicing.



This symbol indicates general information about the product and the user guide.

This symbol also indicates detail information about the specific product configuration.



This symbol precedes helpful hints and tips for daily use.

## For Your Safety

Your new Kontron product was developed and tested carefully to provide all features necessary to ensure its compliance with electrical safety requirements. It was also designed for a long fault-free life. However, the life expectancy of your product can be drastically reduced by improper treatment during unpacking and installation. Therefore, in the interest of your own safety and of the correct operation of your new Kontron product, you are requested to conform with the following guidelines.

### High Voltage Safety Instructions

As a precaution and in case of danger, the power connector must be easily accessible. The power connector is the product's main disconnect device.

#### ⚠ CAUTION

##### Warning

All operations on this product must be carried out by sufficiently skilled personnel only.

#### ⚠ CAUTION



##### Electric Shock!

Before installing a non hot-swappable Kontron product into a system always ensure that your mains power is switched off. This also applies to the installation of piggybacks. Serious electrical shock hazards can exist during all installation, repair, and maintenance operations on this product. Therefore, always unplug the power cable and any other cables which provide external voltages before performing any work on this product.

Earth ground connection to vehicle's chassis or a central grounding point shall remain connected. The earth ground cable shall be the last cable to be disconnected or the first cable to be connected when performing installation or removal procedures on this product.

### Special Handling and Unpacking Instruction

#### NOTICE



##### ESD Sensitive Device!

Electronic boards and their components are sensitive to static electricity. Therefore, care must be taken during all handling operations and inspections of this product, in order to ensure product integrity at all times.

#### ⚠ CAUTION

Handling and operation of the product is permitted only for trained personnel within a work place that is access controlled. Follow the "General Safety Instructions" supplied with the system.

Do not handle this product out of its protective enclosure while it is not used for operational purposes unless it is otherwise protected.

Whenever possible, unpack or pack this product only at EOS/ESD safe work stations. Where a safe work station is not guaranteed, it is important for the user to be electrically discharged before touching the product with his/her hands or tools. This is most easily done by touching a metal part of your system housing.

It is particularly important to observe standard anti-static precautions when changing piggybacks, ROM devices, jumper settings etc. If the product contains batteries for RTC or memory backup, ensure that the product is not placed on conductive surfaces, including anti-static plastics or sponges. They can cause short circuits and damage the batteries or conductive circuits on the product.

## Lithium Battery Precautions

If your product is equipped with a lithium battery, take the following precautions when replacing the battery.

### ⚠ CAUTION

---

**Danger of explosion if the battery is replaced incorrectly.**

- ▶ Replace only with same or equivalent battery type recommended by the manufacturer.
  - ▶ Dispose of used batteries according to the manufacturer's instructions.
- 

## General Instructions on Usage

In order to maintain Kontron's product warranty, this product must not be altered or modified in any way. Changes or modifications to the product, that are not explicitly approved by Kontron and described in this user guide or received from Kontron Support as a special handling instruction, will void your warranty.

This product should only be installed in or connected to systems that fulfill all necessary technical and specific environmental requirements. This also applies to the operational temperature range of the specific board version that must not be exceeded. If batteries are present, their temperature restrictions must be taken into account.

In performing all necessary installation and application operations, only follow the instructions supplied by the present user guide.

Keep all the original packaging material for future storage or warranty shipments. If it is necessary to store or ship the product, then re-pack it in the same manner as it was delivered.

Special care is necessary when handling or unpacking the product. See Special Handling and Unpacking Instruction.

## Quality and Environmental Management

Kontron aims to deliver reliable high-end products designed and built for quality, and aims to complying with environmental laws, regulations, and other environmentally oriented requirements. For more information regarding Kontron's quality and environmental responsibilities, visit <http://www.kontron.com/about-kontron/corporate-responsibility/quality-management>.

## Disposal and Recycling

Kontron's products are manufactured to satisfy environmental protection requirements where possible. Many of the components used are capable of being recycled. Final disposal of this product after its service life must be accomplished in accordance with applicable country, state, or local laws or regulations.

## WEEE Compliance

The Waste Electrical and Electronic Equipment (WEEE) Directive aims to:

- ▶ Reduce waste arising from electrical and electronic equipment (EEE)
- ▶ Make producers of EEE responsible for the environmental impact of their products, especially when the product become waste
- ▶ Encourage separate collection and subsequent treatment, reuse, recovery, recycling and sound environmental disposal of EEE
- ▶ Improve the environmental performance of all those involved during the lifecycle of EEE



---

**Environmental protection is a high priority with Kontron.**  
Kontron follows the WEEE directive

---



# Table of Contents

|  |           |
|--|-----------|
| <b>Symbols</b> .....   | <b>6</b>  |
| <b>For Your Safety</b> .....                                   | <b>7</b>  |
| High Voltage Safety Instructions .....                         | 7         |
| Special Handling and Unpacking Instruction .....               | 7         |
| Lithium Battery Precautions.....                               | 8         |
| <b>General Instructions on Usage</b> .....                     | <b>8</b>  |
| <b>Quality and Environmental Management</b> .....              | <b>8</b>  |
| Disposal and Recycling.....                                    | 8         |
| WEEE Compliance.....   | 8         |
| <b>Table of Contents</b> .....                                 | <b>9</b>  |
| <b>List of Tables</b> .....                                    | <b>11</b> |
| <b>List of Figures</b> .....                                   | <b>11</b> |
| <b>1/ General Safety Instructions</b> .....                    | <b>13</b> |
| 1.1. Electrostatic Discharge (ESD).....                        | 14        |
| 1.1.1. Grounding Methods .....                                 | 14        |
| 1.2. Instructions for Lithium Battery.....                     | 15        |
| <b>2/ Electromagnetic Compatibility (Class B Device)</b> ..... | <b>16</b> |
| 2.1. Electromagnetic Compatibility (EU).....                   | 16        |
| 2.2. FCC Statement (USA).....                                  | 16        |
| 2.3. EMC-Compliance (Canada) .....                             | 16        |
| <b>3/ Shipment and Unpacking</b> .....                         | <b>17</b> |
| 3.1. Packaging.....  | 17        |
| 3.2. Unpacking.....  | 17        |
| 3.3. Scope of Delivery.....                                    | 17        |
| 3.4. Accessories .....   | 17        |
| 3.5. Type Label and Product Identification.....                | 18        |
| 3.6. Kontron Parts (option).....                               | 18        |
| <b>4/ System Overview</b> .....                                | <b>19</b> |
| 4.1. Front Panel Views .....                                   | 20        |
| 4.1.1. Input Power Connector.....                              | 21        |
| 4.1.2. Protective Earth Stud Bolt .....                        | 21        |
| 4.1.3. HDMI.....   | 21        |
| 4.1.4. Display Port (DP) .....                                 | 21        |
| 4.1.5. Ethernet (LAN1, LAN2).....                              | 21        |
| 4.1.6. USB 3.0 Ports .....                                     | 21        |
| 4.1.7. Power-On Switch.....                                    | 21        |
| 4.1.8. Serial Ports (X1, X2).....                              | 21        |
| 4.1.9. Breakouts (X3, X4) .....                                | 21        |
| 4.2. Rear View .....   | 22        |
| 4.3. Top View and Bottom View .....                            | 22        |
| 4.4. Side Views.....   | 23        |
| 4.5. Internal Components .....                                 | 24        |
| 4.5.1. Main On-board Components .....                          | 25        |
| <b>5/ System Expansion</b> .....                               | <b>26</b> |
| 5.1. External Storage Expansion .....                          | 26        |
| 5.2. Internal Expansion .....                                  | 27        |
| 5.2.1. M.2 Module .....  | 27        |

|   |           |
|---|-----------|
| 5.2.2. mPCIe Expansion Cards.....                             | 27        |
| <b>6/ Accessing Components.....</b>                           | <b>28</b> |
| 6.1. Accessing the 2.5" HDD/SSD Drive Bay.....                | 28        |
| 6.2. Opening the System .....                                 | 29        |
| 6.3. Installing and Removing M.2 SSD Card .....               | 32        |
| 6.4. Installing and Removing mPCIe Expansion Cards.....       | 33        |
| <b>7/ Thermal Considerations .....</b>                        | <b>34</b> |
| 7.1. Heatsink Plate.....                                      | 34        |
| 7.2. Heatsink (option) .....                                  | 34        |
| <b>8/ Installation Instructions.....</b>                      | <b>35</b> |
| 8.1. DIN Rail Mounting .....                                  | 35        |
| 8.2. Control Cabinet Mounting .....                           | 36        |
| 8.3. Wiring the Mating Power Connector/Terminal .....         | 37        |
| <b>9/ Switching On.....</b>                                   | <b>39</b> |
| 9.1. Connecting to a DC Power Supply .....                    | 39        |
| 9.2. Switch On .....  | 40        |
| 9.3. Switch Off.....  | 40        |
| 9.4. Operating System (OS) and Drivers .....                  | 40        |
| <b>10/ Technical Data .....</b>                               | <b>41</b> |
| 10.1. Block Diagram.....                                      | 41        |
| 10.2. Technical Specification .....                           | 42        |
| 10.3. Mechanical Specification .....                          | 43        |
| 10.3.1. Mechanical Diagrams.....                              | 43        |
| 10.4. Environmental Specification .....                       | 47        |
| 10.5. Compliance .....  | 48        |
| 10.6. Power Specification .....                               | 50        |
| 10.6.1. Power Supply Protection Requirements.....             | 50        |
| 10.6.2. Power Consumption.....                                | 51        |
| 10.6.3. Protective Earth Stud Bolt.....                       | 51        |
| <b>11/ Connector Pin Assignments .....</b>                    | <b>52</b> |
| 11.1. Front Panel Connector Pin Assignments.....              | 52        |
| 11.1.1. Input Power Connector (- +).....                      | 52        |
| 11.1.2. HDMI Connector (HDMI) .....                           | 52        |
| 11.1.3. Display Port Connector (DP) .....                     | 52        |
| 11.1.4. GbE LAN RJ45 Connectors (LAN1, LAN2) .....            | 53        |
| 11.1.5. USB 3.0 Port Connectors .....                         | 53        |
| 11.1.6. Serial Port Connectors (X1, X2).....                  | 53        |
| 11.2. SBC On-board Connector and Jumper Pin Assignments ..... | 54        |
| 11.2.1. Battery Power Input Connector .....                   | 54        |
| 11.2.2. 12 VDC Out Power Connector .....                      | 54        |
| 11.2.3. HDD Power Output Connector .....                      | 54        |
| 11.2.4. SATA1 and SATA2 Port Connector .....                  | 54        |
| 11.2.5. Serial Port 1 and Serial Port 2 Connector .....       | 55        |
| 11.2.6. USB 2.0 Port Pin Header.....                          | 55        |
| 11.2.7. Audio Input/Output Pin Header.....                    | 55        |
| 11.2.8. Left Channel 3W Audio AMP Output Connector .....      | 56        |
| 11.2.9. Right Channel 3W Audio AMP Output Connector .....     | 56        |
| 11.2.10. Power-on Switch Pin Header .....                     | 56        |
| 11.2.11. USB Power Selection Jumper/SIM Card Jumper .....     | 56        |

|   |           |
|---|-----------|
| <b>12/ BIOS</b> .....                                     | <b>57</b> |
| 12.1. Starting the uEFI BIOS .....                        | 57        |
| 12.2. Setup Menus.....                                    | 58        |
| 12.2.1. Main Setup Menu .....                             | 58        |
| 12.2.2. Advanced Setup Menu .....                         | 59        |
| 12.2.3. Power Setup Menu.....                             | 63        |
| 12.2.4. Boot Setup Menu.....                              | 64        |
| 12.2.5. Security Setup Menu .....                         | 65        |
| 12.2.6. Save and Exit Set up Menu .....                   | 67        |
| <b>13/ Technical Support</b> .....                        | <b>68</b> |
| 13.1. Returning Defective Merchandise .....               | 68        |
| <b>14/ Storage, Transportation and Maintenance</b> .....  | <b>69</b> |
| 14.1. Storage.....  | 69        |
| 14.2. Transportation .....                                | 69        |
| 14.3. Maintenance.....                                    | 69        |
| 14.3.1. Replacing the Lithium Battery .....               | 69        |
| <b>15/ Warranty</b> .....                                 | <b>71</b> |
| 15.1. Limitation/Exemption from Warranty Obligation ..... | 71        |
| <b>Appendix A: List of Acronyms</b> .....                 | <b>72</b> |
| About Kontron .....                                       | 73        |

## List of Tables

|  |    |
|--|----|
| Table 1: Scope of Delivery .....   | 17 |
| Table 2: Accessories .....   | 17 |
| Table 3: Product Identification.....   | 18 |
| Table 4: External Storage Devices .....  | 26 |
| Table 5: M.2 Module Memory Expansion .....   | 27 |
| Table 6: mPCIe Expansion Card Option .....   | 27 |
| Table 7: Technical Specification .....   | 42 |
| Table 8: Mechanical Specification .....  | 43 |
| Table 9: Environmental Specification .....   | 47 |
| Table 10: KBox A-150-KBL without Wi-Fi - Standards, Certifications and Directives Compliance ..... | 48 |
| Table 11: KBox A-150-KBL with Wi-Fi - Standards, Certifications and Directives Compliance.....     | 48 |
| Table 12: Power Specification.....   | 50 |
| Table 13: Power Consumption.....   | 51 |
| Table 14: Navigation Hot Keys Available in the Legend Bar .....                                    | 57 |
| Table 15: Advanced Menu .....  | 59 |
| Table 16: Power Setup Menu Sub-screens and Functions .....   | 63 |
| Table 17: Boot Setup Menu Sub-screens and Functions .....  | 64 |
| Table 18: Security Setup Menu Sub-screens and Functions.....                                       | 65 |
| Table 19: Save and Exit Setup Menu Sub-screens and Functions.....                                  | 67 |
| Table 20: List of Acronyms.....  | 72 |

## List of Figures

|  |    |
|--|----|
| Figure 1: Type Label Example .....   | 18 |
| Figure 2: KBox A-150-KBL Drive Bay Variant with Optional Wi-Fi solution .....            | 19 |
| Figure 3: Front Panel (with external 2.5" HDD/SSD drive bay) .....                       | 20 |
| Figure 4: Front Panel (no external drive bay) .....                                      | 20 |
| Figure 5: Rear View .....  | 22 |
| Figure 6: Top View and Bottom View .....   | 22 |
| Figure 7: Left Side View and Right Side View (with external 2.5" HDD/SSD drive bay)..... | 23 |

|   |    |
|---|----|
| Figure 8: Left Side View and Right Side View (with no external drive bay) .....                                 | 23 |
| Figure 9: Internal Components .....   | 24 |
| Figure 10: Main On-board Connectors.....  | 25 |
| Figure 11: 2.5" HDD/SSD Drive Bay .....   | 28 |
| Figure 12: SBC Fastening Screws.....  | 30 |
| Figure 13: Front Panel Fastening Screws.....  | 30 |
| Figure 14: Removing the Front panel- SBC Assembly.....  | 31 |
| Figure 15: M.2 Module on the SBC .....  | 32 |
| Figure 16: mPCIe Expansion Card on the SBC .....  | 33 |
| Figure 17: Heatsink and Heatsink with DIN Rail Clamp.....   | 34 |
| Figure 18: DIN Rail Clamp Upper Position .....  | 35 |
| Figure 19: DIN Rail Clamp Screw Dimensions (mm).....  | 35 |
| Figure 20: Keep Out Area for Mounting for KBox A-150-KBL (with external 2.5" HDD/SSD drive bay).....            | 36 |
| Figure 21: Keep Out Area for Mounting for KBox A-150-KBL (with no drive bay) .....                              | 36 |
| Figure 22: Keep Out Area for Mounting for KBox A-150-KBL (with heatsink & external 2.5" HDD/SSD drive bay)..... | 36 |
| Figure 23: Keep Out Area for Mounting for KBox A-150-KBL (with heatsink & no drive bay).....                    | 36 |
| Figure 24: Keep Out Area for installed dual Wi-Fi Antenna (with external 2.5" HDD/SSD drive bay) .....          | 37 |
| Figure 25: Input Power Connector and Mating Power Connector/Terminal.....                                       | 37 |
| Figure 26: Block Diagram .....  | 41 |
| Figure 27: Front Panel Dimensions with External 2.5" HDD/SSD Drive Bay (mm) .....                               | 43 |
| Figure 28: Rear Side Dimensions with External 2.5" HDD/SSD Drive Bay (mm) .....                                 | 43 |
| Figure 29: Top Side Dimensions with External 2.5" HDD/SSD Drive Bay (mm).....                                   | 44 |
| Figure 30: Side View Dimensions with External 2.5" HDD/SSD Drive Bay (mm).....                                  | 44 |
| Figure 31: Front Panel Dimensions without Drive Bay (mm) .....  | 44 |
| Figure 32: Rear Side Dimensions without Drive Bay (mm).....   | 45 |
| Figure 33: Top Side Dimensions without Drive Bay (mm) .....   | 45 |
| Figure 34: Side View Dimensions without Drive Bay (mm).....   | 45 |
| Figure 35: Mechanical Diagram Heatsink (mm) .....   | 46 |
| Figure 36: Main Setup Menu Example.....   | 58 |
| Figure 37: Advanced Setup Menu Example.....   | 59 |
| Figure 38: Power Setup Menu Example.....  | 63 |
| Figure 39: Boot Setup Menu Example.....   | 64 |
| Figure 40: Security Setup Menu Example .....  | 65 |
| Figure 41: Save and Exit Set up Menu Example .....  | 67 |
| Figure 42: Lithium Battery Location .....   | 69 |
| Figure 43: Lithium Battery Power Input Connector .....  | 70 |

## 1/ General Safety Instructions

Please read this passage carefully and take careful note of the instructions, which have been compiled for your safety and to ensure to apply in accordance with intended regulations. If the following general safety instructions are not observed, it could lead to injuries to the operator and/or damage of the product; in cases of non-observance of the instructions Kontron Europe is exempt from accident liability, this also applies during the warranty period.

The product has been built and tested according to the basic safety requirements for low voltage (LVD) applications and has left the manufacturer in safety-related, flawless condition. To maintain this condition and to also ensure safe operation, the operator must not only observe the correct operating conditions for the product but also the following general safety instructions:

- ▶ The product must be used as specified in the product documentation, in which the instructions for safety for the product and for the operator are described. These contain guidelines for setting up, installation and assembly, maintenance, transport or storage.
- ▶ The on-site electrical installation must meet the requirements of the country's specific local regulations.
- ▶ If a power cable comes with the product, only this cable should be used. Do not use an extension cable to connect the product.
- ▶ To guarantee that sufficient air circulation is available to cool the product, please ensure that the ventilation openings are not covered or blocked. If a filter mat is provided, this should be cleaned regularly. Do not place the product close to heat sources or damp places. Make sure the product is well ventilated.
- ▶ Only connect the product to an external power supply providing the voltage type (AC or DC) and the input power (max. current) specified on the Kontron Product Label and meeting the requirements of the Limited Power Source (LPS) and Power Source (PS2) of UL/IEC 62368-1.
- ▶ Only products or parts that meet the requirements for Power Source (PS1) of UL/IEC 62368-1 may be connected to the product's available interfaces (I/O).
- ▶ Before opening the product, make sure that the product is disconnected from the mains.
- ▶ Switching off the product by its power button does not disconnect it from the mains. Complete disconnection is only possible if the power cable is removed from the wall plug or from the product. Ensure that there is free and easy access to enable disconnection.
- ▶ The product may only be opened for the insertion or removal of add-on cards (depending on the configuration of the product). This may only be carried out by qualified operators.
- ▶ If extensions are being carried out, the following must be observed:
  - ▶ all effective legal regulations and all technical data are adhered to
  - ▶ the power consumption of any add-on card does not exceed the specified limitations
  - ▶ the current consumption of the product does not exceed the value stated on the product label.
- ▶ Only original accessories that have been approved by Kontron Europe can be used.
- ▶ Please note: safe operation is no longer possible when any of the following applies:
  - ▶ the product has visible damages or
  - ▶ the product is no longer functioning
 In this case the product must be switched off and it must be ensured that the product can no longer be operated.
- ▶ Handling and operation of the product is permitted only for trained personnel within a work place that is access controlled.
- ▶ CAUTION: Risk of explosion if the battery is replaced incorrectly (short-circuited, reverse-poled, wrong battery type). Dispose of used batteries according to the manufacturer's instructions.
- ▶ This product is not suitable for use in locations where children are likely to be present

### Additional Safety Instructions for DC Power Supply Circuits

- ▶ To guarantee safe operation, please observe that:
  - ▶ the external DC power supply must meet the criteria for LPS and PS2 (UL/IEC 62368-1)

- ▶ no cables or parts without insulation in electrical circuits with dangerous voltage or power should be touched directly or indirectly
  - ▶ a reliable protective earthing connection is provided
  - ▶ a suitable, easily accessible disconnecting device is used in the application (e.g. overcurrent protective device), if the product itself is not disconnectable
  - ▶ a disconnect device, if provided in or as part of the product, shall disconnect both poles simultaneously
  - ▶ interconnecting power circuits of different products cause no electrical hazards
- ▶ A sufficient dimensioning of the power cable wires must be selected – according to the maximum electrical specifications on the product label – as stipulated by EN62368-1 or VDE0100 or EN60204 or UL61010-1 regulations.

## 1.1. Electrostatic Discharge (ESD)



---

**A sudden discharge of electrostatic electricity can destroy static-sensitive devices or micro-circuitry.**

---

Therefore, proper packaging and grounding techniques are necessary precautions to prevent damage. Always take the following precautions:

1. Transport boards in ESD-safe containers such as boxes or bags.
2. Keep electrostatic sensitive parts in their containers until they arrive at the ESD-safe workplace.
3. Always be properly grounded when touching a sensitive board, component, or assembly.
4. Store electrostatic-sensitive boards in protective packaging or on antistatic mats.

### 1.1.1. Grounding Methods

By adhering to the guidelines below, electrostatic damage to the product can be avoided:

1. Cover workstations with approved antistatic material. Always wear a wrist strap connected to workplace. Always use properly grounded tools and equipment.
2. Use antistatic mats, heel straps, or air ionizers for more protection.
3. Always handle electrostatically sensitive components by their edge or by their casing.
4. Avoid contact with pins, leads, or circuitry.
5. Switch off power and input signals before inserting and removing connectors or connecting test equipment.
6. Keep work area free of non-conductive materials such as ordinary plastic assembly aids and Styrofoam.
7. Use only field service tools that are conductive, such as cutters, screwdrivers, and vacuum cleaners.
8. Always place drives and boards PCB-assembly-side down on the foam.

## 1.2. Instructions for Lithium Battery

The KBox A-150-KBL is equipped with a Kontron specific battery assembly and is not designed to operate without a battery. If the battery is empty or disconnected, the BIOS settings will be set to the factory defaults. To replace the battery, observe the instructions described in Chapter 14.3.1: Replacing the Lithium Battery.

### **CAUTION**

---

Caution: Risk of Explosion if Battery is replaced by an Incorrect Type. Dispose of Used Batteries According to the Instructions.

ATTENTION: Risque d'explosion si la batterie est remplacée par un type incorrect. Mettre au rebus les batteries usagées selon les instructions.

---



---

Do not dispose of lithium batteries in general trash collection. Dispose of the battery according to the local regulations dealing with the disposal of these special materials, (e.g. to collecting points for battery disposal).

---

## 2/ Electromagnetic Compatibility (Class B Device)

### 2.1. Electromagnetic Compatibility (EU)

This product complies with the European Council Directive on the approximation of the laws of the member states relating to electromagnetic compatibility (EMC) directive 2014/30/EU ensuring that electrical and electronic equipment does not generate, or is not affected by, electrical disturbance.

The EMC directive 2014/30/EU limits electromagnetic emissions from products to ensure that, when used as intended, the product does not disturb radio and telecommunication, or other equipment. The directive also governs the immunity of the product to interference and seeks to ensure that the product is not disturbed by radio emissions, when used as intended.

### 2.2. FCC Statement (USA)

This product has been tested and found to comply with Part 15 of the Federal Communications Commission (FCC) Rules for Class B products. These limits are designed to provide reasonable protection against harmful interference in a residential installation. This product generates, uses and can radiate radio frequency energy and, if not installed and used in accordance with the instructions, may cause harmful interference to radio communications. However, there is no guarantee that interference will not occur in a particular installation.

If this product does cause harmful interference to radio or television reception, that can be determined by turning the equipment off and on, the user is encouraged to try to correct the interference by one or more of the following measures:

- ▶ Reorient or relocate the receiving antenna.
- ▶ Increase the separation between the product and receiver.
- ▶ Connect the product into an outlet on a circuit different from that to which the receiver is connected.
- ▶ Consult the dealer or an experienced radio/TV technician for help.

Kontron is not responsible for any radio television interference caused by unauthorized modifications of this product or the substitution or attachment of connecting cables and devices other than those specified by Kontron. The correction of interference caused by such unauthorized modification, substitution or attachment will be the responsibility of the user.

The use of shielded I/O cables is required when connecting this product to any and all optional peripheral or host devices. Failure to do so may violate FCC and ICES rules.

### 2.3. EMC-Compliance (Canada)

The method of compliance is self-declaration:

(English): This Class B product complies with the Canadian ICES-003.

(French) : Cet appareil numérique de la class B est conforme à la norme NMB-003 du Canada.



## 3/ Shipment and Unpacking

### 3.1. Packaging

All parts are delivered together in a product specific cardboard package designed to provide adequate protection to absorb shock. Kontron recommends keeping the packaging to store or transport the product.

### 3.2. Unpacking

To unpack the product, perform the following:

1. Remove packaging.
2. Do not discard the original packaging. Keep the original packaging for future transportation or storage.
3. Check the delivery for completeness by comparing the delivery with the original order.
4. Keep the associated paperwork. It contains important information for handling the product.
5. Check the contents for visible shipping damage.
6. If you notice any shipping damage or inconsistencies between the contents and the original order, contact Kontron for help and information.

### 3.3. Scope of Delivery

Check that your delivery is complete, and contains the items listed below. If you discover damaged or missing items, contact your dealer.

**Table 1: Scope of Delivery**

| Delivered Item              | Part Description  |
|-----------------------------|---|
| KBox A-150-KBL              | Corresponding to the ordered product configuration  |
| Phoenix Power Connector     | 3-pin mating power connector/terminal (PSC 1,5/ 3-F) inserted on Input Power connector  |
| DIN Rail Clamp              | DIN rail clamp installed on the rear side using 2x M4x6 screws  |
| HDD Protective Film         | Adhesive protective film attaches to the 2.5"HDD/SDD to protect the HDD/SSD against antistatic electrification when touched. ( External drive bay variant only) |
| General Safety Instructions | General safety instruction when operating or handling IT equipment  |

### 3.4. Accessories

**Table 2: Accessories**

| Part Number            | Part                    | Part Description   |
|------------------------|-------------------------|--|
| EE04-100001-01         | Power connector (3-pin) | Phoenix mating power connector/terminal (PSC 1,5/ 3-F) in DSUB 9 housing |
| ER40-100001-01         | Power Supply 24 V       | External AC/DC PSU with 50 W, 24 VDC at 40°C                             |
| 840-0059               | Power cable EU          | Power cable AC mains to external adapter, Europe, UK and USA             |
| 840-0115               | Power cable UK          |  |
| 840-0405 / 0-0064-4317 | Power cable US          |  |
| PM00-100057-01         | HDD/SSD extension frame | Adjusts drives installation height from 7 mm to 9 mm                     |
| EN05-100003-01         | Heatsink kit            | Heatsink with four screws (M4x8 )  |

### 3.5. Type Label and Product Identification

The KBox A-150-KBL is part of Kontron's DIN rail embedded Box PC. Kontron's A-Series is intended for control cabinet applications.

Table 3: Product Identification

| System Type | Product Designation | Model          | Description   |
|-------------|---------------------|----------------|---|
| KBox A      | KBox A-150          | KBox A-150-KBL | Corresponds to system configurations with the ECX-KLU0, 3.5" ECX Single Board Computer with Intel® Core™ i5-7300U processor |

The type label contains specific product identification information and KBox A-150-KBL technical information.

Figure 1: Type Label Example

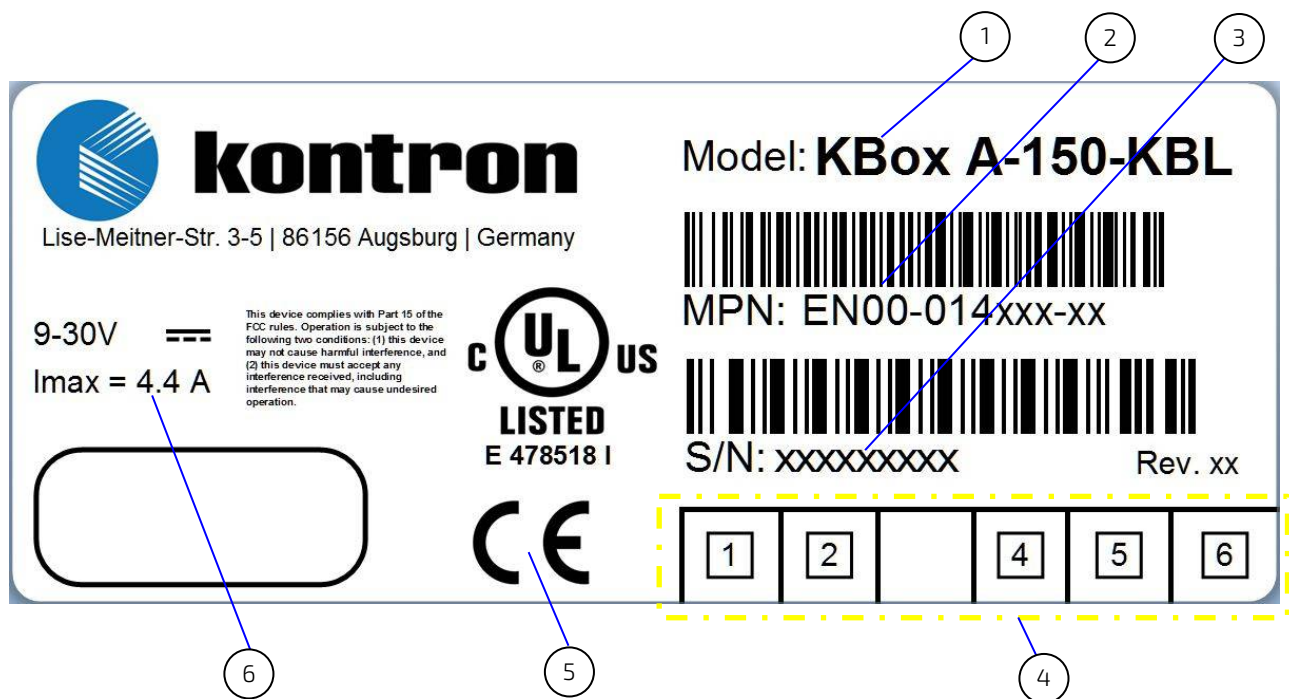

- |   |                             |
|---|-----------------------------|
| 1 Model                                   | 4 For internal use          |
| 2 Material Part Number(MPN) with bar code | 5 Certification information |
| 3 Serial Number (S/N) with barcode        | 6 Technical information     |

### 3.6. Kontron Parts (option)

The APPROTECT security solution is based on WIBU-Systems CodeMeter® in tandem with a specifically developed software framework. APPROTECT provides full IP and copy/reverse engineering protection through an optional WIBU-Systems security chip. For more information, contact [Kontron Support](#).

## 4/ System Overview

This user guide specifies the main technical features of the KBox A-150-KBL, DIN rail industrial computer platform and includes detailed information and guidelines for set up, assembly, installation, maintenance, transport and storage. Before working with the KBox A-150-KBL, Kontron recommends that users take a few minutes to learn about the KBox A-150-KBL's various parts. New users are recommended to study the instructions and any warning notices within this user guide before handling or switching on the product.

The KBox A-150-KBL is a flexible fanless industrial grade DIN rail embedded box PC designed for use in performance demanding applications requiring flexible DIN rail mounting positions in limited space, 24/7 continuous operation and longtime industrial employment.

Based on a Single Board Computer (SBC) using the Intel® Core™ i5-7300U platform, the KBox A-150-KBL features a variety of on-board interfaces to enable connectivity to nearly all applications. An internal M.2 Key B socket supports up to 512 GBytes of memory expansion and an internal mPCIe slot enables Wi-Fi/Bluetooth (BT) expansion. All components are selected to ensure a long lifetime and the fanless design ensures a significantly prolonged lifespan and high system availability.

The KBox A-150-KBL's robust steel chassis is designed for horizontal or vertical operation in a DIN rail control cabinet. The chassis height increases when the KBox A-150 KBL includes an externally accessible 2.5" HDD/SSD drive bay.

General features are:

- ▶ Intel® Core™ i5-7300U
- ▶ Up to 32 GB RAM with 2x DDR4 SODIMMs
- ▶ Up to 512 GB memory storage via M.2 SSD (option)
- ▶ External 2.5" HDD/SSD drive bay (option)
- ▶ External Interfaces: 1x HDMI, 1x DP, 2x GbE, 4x USB 3.0, 2x COM (RS232, RS422, RS485 configurable)
- ▶ Expansion: 1x mPCIe expansion card (full-size)
  - ▶ Wi-Fi (2.4GHz/5GHz) /Bluetooth (4.1) combo solution (option)
- ▶ Fanless passive cooling
- ▶ Supports Kontron's APPROTECT (option)

Figure 2: KBox A-150-KBL Drive Bay Variant with Optional Wi-Fi solution



### NOTICE

#### Protection label

The KBox A-150-KBL is factory configured to meet customer requirements and then sealed with a protection label. Opening the KBox A-150-KBL invalidates the warranty and may cause damage to internal components.



The KBox A-150-KBL is designed for horizontal or vertical operation in a DIN rail control cabinet.

## 4.1. Front Panel Views

The front panel includes all I/O connectors.



The protective earth stud bolt's position varies depending on whether the KBox A-150-KBL includes an external 2.5" HDD/SSD drive bay.

Figure 3: Front Panel (with external 2.5" HDD/SSD drive bay)

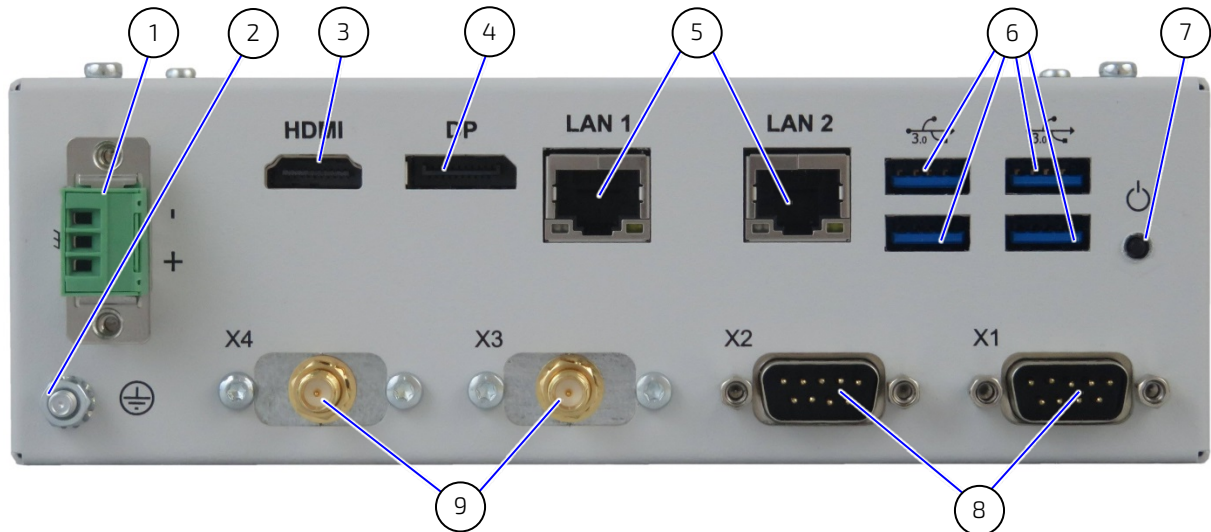
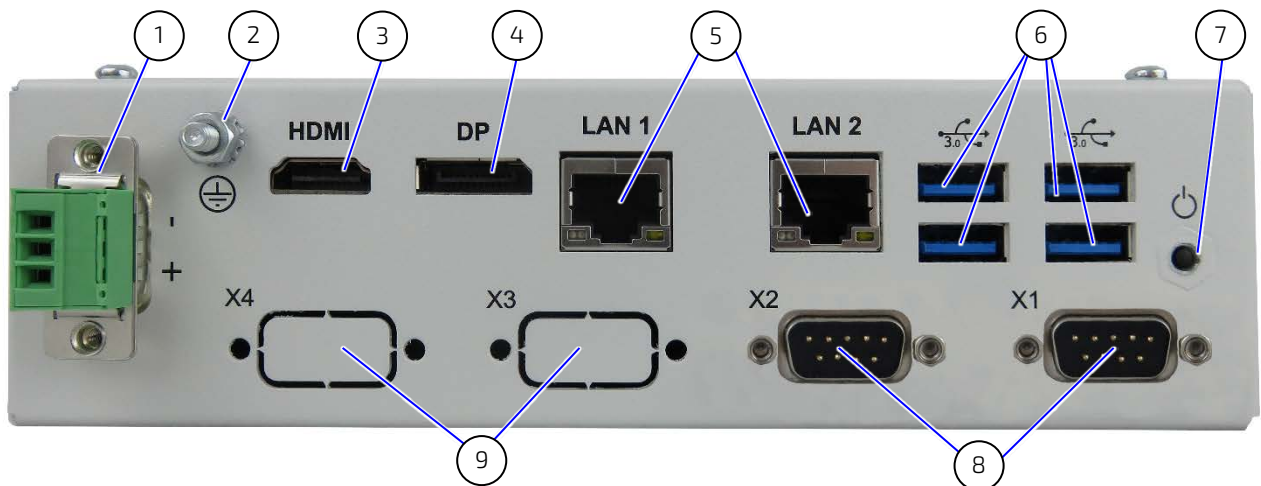

Figure 4: Front Panel (no external drive bay)



- |   |  |   |   |
|---|--|---|---|
| 1 | Input Power connector (shown with mating power connector/terminal) | 5 | 2x GbE LAN  |
| 2 | Protective earth stud bolt   | 6 | 4x USB 3.0 ports  |
| 3 | HDMI connector   | 7 | Power-on switch   |
| 4 | Display Port (DP)  | 8 | 2x Serial ports   |
|   |  | 9 | 2x Breakouts (shown in Figure 3 with Wi-Fi antenna connector) |

### 4.1.1. Input Power Connector

The 3-pin input power connector (PSC 1,5/ 3-M) connects to the appropriate DC power supply using the supplied mating power connector/terminal (PSC 1,5/ 3-F) , see Figure 3 and Figure 4, pos. 1. For information on how to wire the mating power connector/terminal, see Chapter 8.3: Wiring the Mating Power Connector/Terminal. For the pin assignment of the Input power connector, see Chapter 11.1.1: Input Power Connector (- +).

### 4.1.2. Protective Earth Stud Bolt

There is a protective earth stud bolt on the front panel connected to the chassis GND. The position of the protective earth stud bolt varies (Figure 3, pos. 2) and (Figure 4, pos. 2).



---

The position of the protective earth stud bolt varies depending on whether the product variant includes an external 2.5" HDD/SSD drive bay.

---

### 4.1.3. HDMI

There is one HDMI 1.4 interface (3840 x 2160 @ 30Hz), for video/audio solutions, see Figure 3 and Figure 4, pos.3. For the pin assignment of the HDMI connector, see Chapter 11.1.2: HDMI Connector (HDMI).

### 4.1.4. Display Port (DP)

There is one DP 1.2 interface (4096 x 2160 @ 60Hz) for video only, see Figure 3 and Figure 4, pos.4. For the pin assignment of the DP connector, see Chapter 11.1.3: Display Port Connector (DP).

### 4.1.5. Ethernet (LAN1, LAN2)

There are two GbE LAN ports both supporting 10/100/100 Mbit Ethernet, see Figure 3 and Figure 4, pos.5. For the pin assignment of the RJ45 Ethernet connectors, see Chapter 11.1.4: GbE LAN RJ45 Connectors (LAN1, LAN2).

### 4.1.6. USB 3.0 Ports

There are four USB 3.0 ports (type A) allowing for the connection of a USB 3.0/USB 2.0 compatible devices, see Figure 3 and Figure 4, pos.6. For the pin assignment of the USB 3.0 connector, see Chapter 11.1.5: USB 3.0 Port Connectors.

### 4.1.7. Power-On Switch

There is a power-on switch on the front panel to apply power or perform an orderly shutdown, see Figure 3 and Figure 4, pos.7. The power-on switch is controlled by the on-board power-on switch pin header, see Chapter 11.2.10: Power-on Switch.

### 4.1.8. Serial Ports (X1, X2)

The two serial ports (X1) and (X2) support RS232/422/485, see Figure 3 and Figure 4, pos.8. The supported serial port type is configured in the BIOS setup menu: **Advanced>Super IO Configuration> Serial Port # Configuration> Serial Port # Type>**. For the pin assignment of the serial port connector, see Chapter 11.1.6: Serial Port Connectors (X1, X2).

### 4.1.9. Breakouts (X3, X4)

The two breakouts that can be used to install Wi-Fi antennas, if the WI-FI + Bluetooth combo mPCIe expansion card is implemented, see Figure 3, pos. 9 or for further custom IO expansion e.g. additional serial ports, see Figure 4, pos.9.

## 4.2. Rear View

Figure 5: Rear View

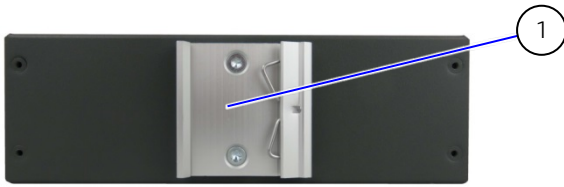

- 1 DIN rail clamp

## 4.3. Top View and Bottom View

Figure 6: Top View and Bottom View

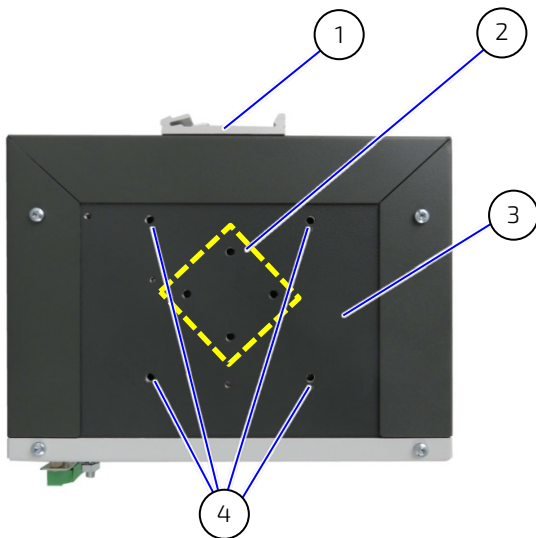

- 1 DIN rail clamp
- 2 2x DIN rail mounting hole pairs (M4 x 6 mm) for horizontal and vertical mounting

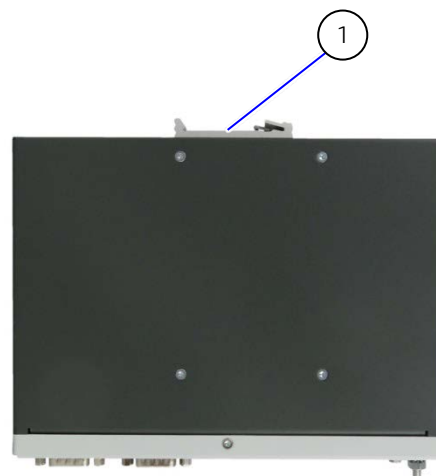

- 3 Heatsink plate on top side
- 4 4x Mounting holes for the heatsink

## 4.4. Side Views

The 2.5" HDD/SSD drive bay is located on the left side. The height of the KBox A-150-KBL's chassis increases with the external 2.5" HDD/SSD drive bay option:

- ▶ 58 mm high with drive bay
- ▶ 50 mm high without drive bay

Figure 7: Left Side View and Right Side View (with external 2.5" HDD/SSD drive bay)

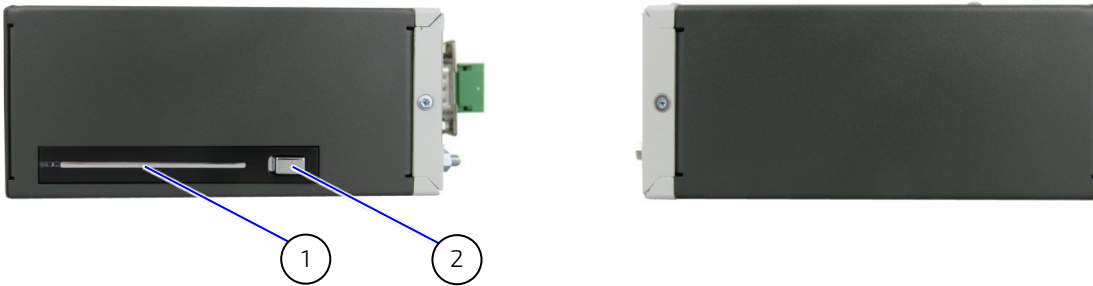
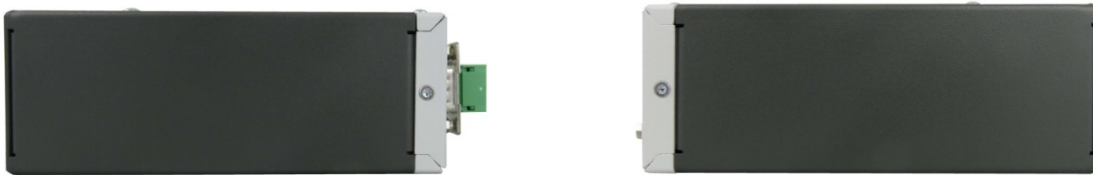

Figure 8: Left Side View and Right Side View (with no external drive bay)



1 2.5" HDD/SSD drive bay cover

2 Drive bay eject button



## 4.5. Internal Components

Figure 9: Internal Components

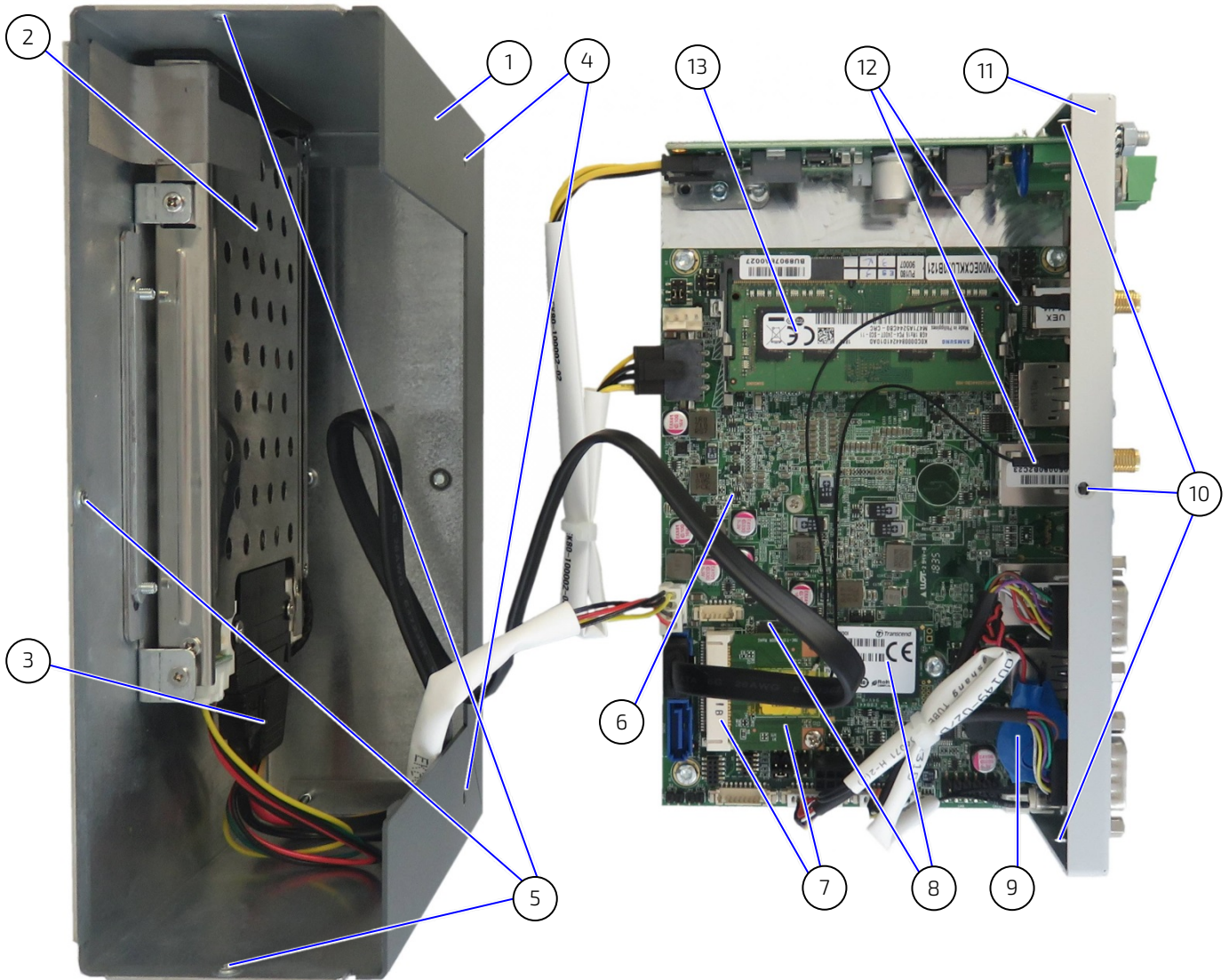

- |   |   |    |   |
|---|---|----|---|
| 1 | Main chassis  | 7  | 1x mPCIe slot with card   |
| 2 | 2.5" HDD/SSD drive bay  | 8  | 1x M.2 socket with module   |
| 3 | SATA connector  | 9  | Lithium battery   |
| 4 | 2x Screw holes for 2x bottom head (M3x5) screws   | 10 | 3x Front panel screw holes for 3x flathead (M2 5x6) screws<br>(Corresponding to main chassis screw holes, pos. 5) |
| 5 | 3x Main chassis screws holes for 3x flathead (M2 5x6) screws.<br>(Corresponding to front panel screw holes, pos.10) | 11 | Front panel   |
| 6 | 3.5" SBC  | 12 | 2x Wi-Fi antenna cables   |
|   |   | 13 | System memory (DIMM1, DIMM2)  |



### 4.5.1. Main On-board Components

Figure 10: Main On-board Connectors

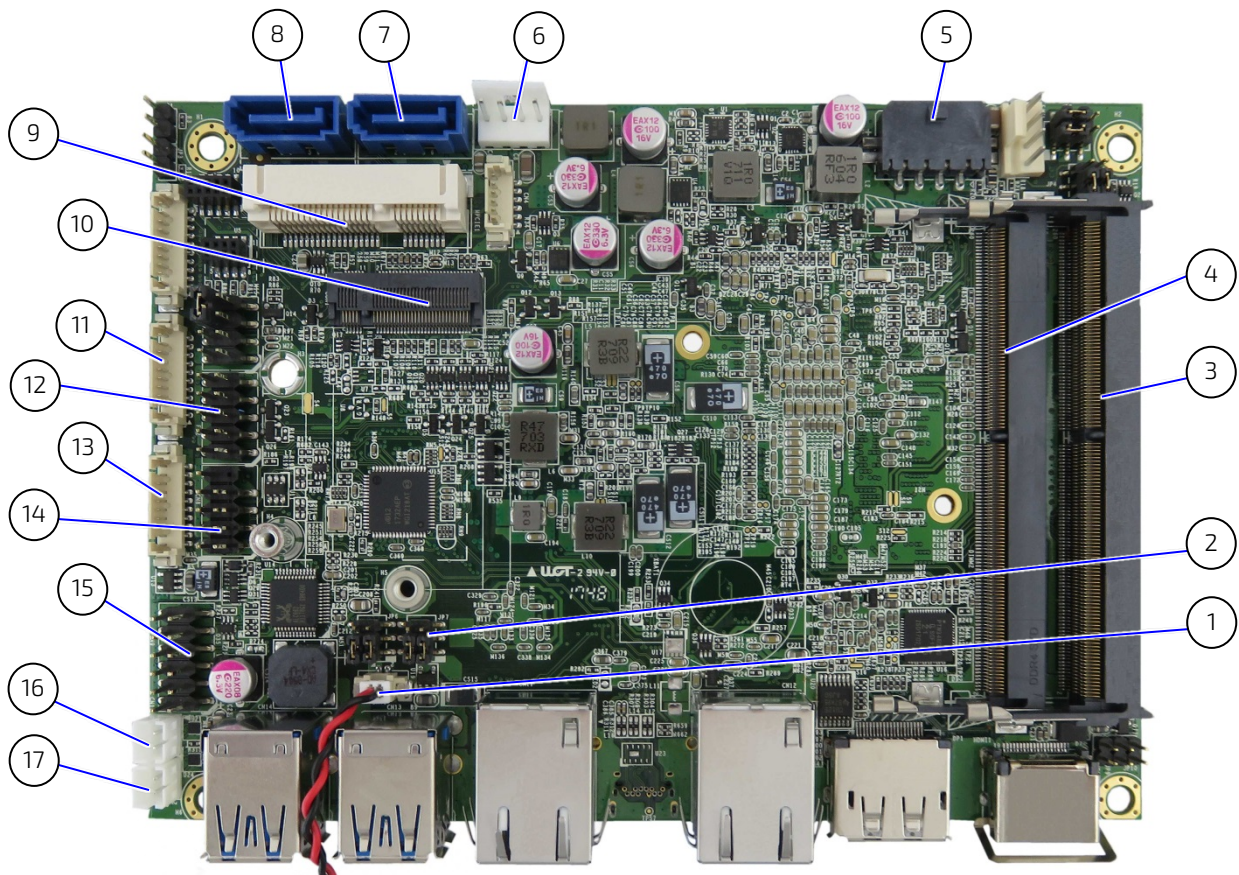

- |   |  |    |   |
|---|--|----|---|
| 1 | Lithium battery power input connector  | 10 | M.2 key B socket                            |
| 2 | USB power selection jumper             | 11 | Serial port 1 connector                     |
| 3 | DIMM1                                  | 12 | Power on switch front panel pin header      |
| 4 | DIMM2                                  | 13 | Serial port 2 connector                     |
| 5 | 12 VDC input power connector           | 14 | USB 2.0 port pin header                     |
| 6 | HDD/SSD power output connector         | 15 | Audio input/output pin header               |
| 7 | SATA1 connector for external drive bay | 16 | Left channel 3W audio AMP output connector  |
| 8 | SATA2 connector                        | 17 | Right channel 3W audio AMP output connector |
| 9 | mPCIe slot                             |    |   |



For the main on-board connector pin assignments, see Chapter 11.2: SBC On-board Connector and Jumper Pin Assignments.

## 5/ System Expansion

Observe the procedures and instructions within this chapter properly when installing, removing or handling internal component. It is recommended to expand the system with internal components, before installing in an industrial control cabinet.

### NOTICE

#### Protection label

The KBox A-150-KBL is factory configured to meet customer requirements and then sealed with a protection label. Opening the KBox A-150-KBL invalidates the warranty and may cause damage to internal components.

### WARNING

Before opening the KBox A-150-KBL, the product must be switched off using the power-on switch, and disconnect all peripheral devices. Disconnect the product by removing the power cable from the DC power supply or the mains power socket. Observe the General Safety Instructions within this user guide.



#### ESD Sensitive

Follow the safety instructions for components that are sensitive to electrostatic discharge (ESD). Failure to observe this warning notice may result in damage to the product or/and internal components.



Pay attention to manufacturer's instructions before installing/removing expansion cards. Due to the limited predetermined lifespan of expansion devices, Kontron recommends that users check on the condition of installed expansion devices regularly and pay attention to the manufacturer's lifespan specifications.

Depending on the ordered system configuration, the KBox A-150-KBL can be extended externally and internally with:

- ▶ 2.5" HDD/SSD drive bay (external)
- ▶ 1x mPCIe (full-size) slot (Internal)
- ▶ 1x M.2 2242 Key B socket (Internal)

When adding expansion devices, observe that the maximum power consumption does not exceed the maximum PSU specification, see Table 13: Power Consumption.

### 5.1. External Storage Expansion

For externally accessible memory expansion, the KBox A-150-KBL drive bay variant supports one 2.5" HDD/SSD slim drive.

Table 4: External Storage Devices

| Storage Device                         | Description   |
|--|---|
| 2.5" HDD/SSD slim drive <sup>[1]</sup> | Both 9.5 mm and 7 mm high HDD/SSDs can be used.<br>Note: For 7 mm HDD/SSDs use the extension frame, see Table 2: Accessories. |

<sup>[1]</sup> For the KBox A-150-KBL drive bay variant only.



Due to the manufacturer's limited specified lifespan for HDD/SSD drives. Kontron recommends checking installed HDD/SSD drives via S.M.A.R.T. regularly.

## 5.2. Internal Expansion

The KBox A-150-KBL supports one M.2 (2242) SSD module and one mPCIe (full-size) expansion card. Kontron recommends the use of Kontron reference M.2 modules and mPCIe cards.

### NOTICE

#### Protection label

The KBox A-150-KBL is factory configured to meet customer requirements and then sealed with a protection label. Opening the KBox A-150-KBL invalidates the warranty and may cause damage to internal components.

### 5.2.1. M.2 Module

Support for one M.2 (2242) SSD module with a maximum capacity of up to 512 GByte. For more information regarding Kontron reference M.2 SSDs, see Table 5: M.2 Module Memory Expansion.

Table 5: M.2 Module Memory Expansion

| Storage Device           | Description  |
|--------------------------|--|
| 1x M.2 (2242) SSD module | M.2 Key B,<br>2242 (width 22 mm and length 42 mm)<br>SATA SSD drive<br>Capacity: 32 GByte, 64 GByte, 128 GByte, 256 GByte or 512 GByte |

### 5.2.2. mPCIe Expansion Cards

Support for one mPCIe version 1.2 (full-size) expansion card. For more information regarding Kontron reference mPCIe expansion cards, see Table 6: mPCIe Expansion Card Option.

Table 6: mPCIe Expansion Card Option

| mPCIe Expansion card       | Description  |
|----------------------------|--|
| 1x Wi-Fi mPCIe (half-size) | Dual band frequencies (2.4 GHz & 5 GHz)<br>Bluetooth (BT) 4.1+HS<br>IEEE802.11 ac/abgn Wi-Fi certified<br>Speeds 300 Mbps max. on N & 867 Mbps on AC |



Only full-size mPCIe expansion cards are supported.

The reference Wi-Fi mPCIe expansion card is half-size and factory installed using a half-size to full-size adapter.

## 6/ Accessing Components

This chapter contains important information regarding accessing components. Observe the procedures and instructions within this chapter properly when installing, removing or handling any system component.

### NOTICE

#### Protection label

The KBox A-150-KBL is factory configured to meet customer requirements and then sealed with a protection label. Opening the KBox A-150-KBL invalidates the warranty and may cause damage to internal components.

### WARNING

Before opening the KBox A-150-KBL, the product must be switched off using the power-on switch, and disconnect all peripheral devices. Disconnect the product by removing the power cable from the DC power supply or the mains power socket. Observe the General Safety Instructions within this user guide.



#### ESD Sensitive

Follow the safety instructions for components that are sensitive to electrostatic discharge (ESD). Failure to observe this warning notice may result in damage to the product or/and internal components.



Pay attention to manufacturer's instructions before installing/removing expansion cards.

Due to the limited predetermined lifespan of expansion devices, Kontron recommends that users check on the condition of installed expansion devices regularly and pay attention to the manufacturer's lifespan specifications.

### 6.1. Accessing the 2.5" HDD/SSD Drive Bay

To install or remove a 2.5" HDD/SSD drive (7 mm or 9.5 mm) in the 2.5" HDD/SSD drive bay, perform the following:

1. Close all applications. Shut down properly using the power-on switch and disconnect the power cable from the DC power supply.
2. Slide the drive bay eject button to the left (Figure 11, pos. 2), to release the drive bay cover and gain access to the drive bay. When released the drive bay cover flips open automatically. (Figure 11, pos. 3)

Figure 11: 2.5" HDD/SSD Drive Bay

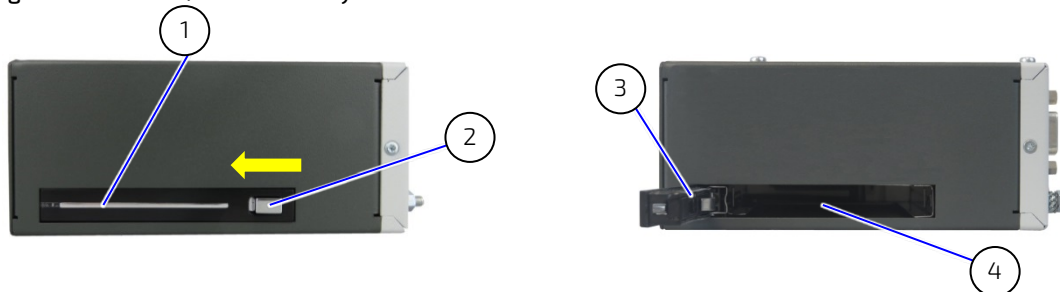

- 1 Drive bay cover (closed)
- 2 Drive bay eject button

- 3 Drive bay cover (open)
- 4 Drive bay

3. Remove an existing drive by holding the sides of the drive and carefully pulling the drive out of the drive bay.

4. Insert a 9.5 mm high drive into the drive bay by carefully pushing the drive into the drive bay, with the drive's contacts facing inward, until the connectors attach. Alternatively, attach an extension frame to a 7 mm high drive and insert the drive with extension frame into the drive bay with the drive's contacts facing inward, until the connectors attach.



---

Attaching an extension frame for 7 mm to 9.5 mm to 7 mm high drives adjusts the height and ensure that the HDD/SSD is inserted correctly into the drive bays internal SATA data and SATA power connectors.

---

5. Push the drive bay cover into the closed position (Figure 11, pos. 1) until the drive bay eject button clicks.

## 6.2. Opening the System

To access the internal component, open the system as described in this chapter and following the installing and removing instructions and procedures.

### NOTICE

#### Protection label

The KBox A-150-KBL is factory configured to meet customer requirements and then sealed with a protection label. Opening the KBox A-150-KBL invalidates the warranty and may cause damage to internal components.

### WARNING

Before opening the KBox A-150-KBL, the product must be switched off using the power-on switch, and disconnect all peripheral devices. Disconnect the product by removing the power cable from the DC power supply or the mains power socket. Observe the General Safety Instructions within this user guide.

Only qualified personnel aware of the associated dangers must perform activities inside the chassis!

### WARNING

KBox A-150 KBL is to be operated in closed condition only

It is only ensured that users do not have access to internal components during operation if closed and the front panel SBC assembly screws (Figure 12, pos. 1) & (Figure 13, pos. 1 & 2) are secured.

To access KBox A-150-KBL internal components, perform the following:

1. Close all applications. Shut down properly using the power-on switch and disconnect the power cable from the DC power supply. Disconnect all peripherals.
2. Place on a flat, clean and ESD-safe surface with the top side facing upwards.
3. The front panel is attached to the SBC. Remove the two screws shown in Figure 12, pos. 1, to release the front panel-SBC assembly. Retain the screws for later use.

Figure 12: SBC Fastening Screws

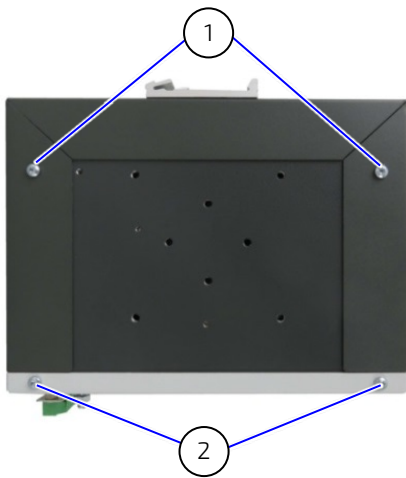

- 1 2x Bottom head torx (M3x5) screws
- 2 2x Screws fasten the front panel to SBC to form a Front panel-SBC assembly that slides in/out of the chassis.  
Do not remove or loosen the screws!

**NOTICE**

Do not remove or loosen the two screws (Figure 12, pos. 2) that fasten the front panel and SBC together to form a SBC-front panel assembly that can slide in/ out of the chassis.

4. Turn the system around with the bottom side facing upwards. Remove the screw located in the middle of the front panel (Figure 13, Pos. 1). Then, remove the two screws located on the front panel's right and left sides (Figure 13, Pos. 2). Retain the screws for later use.

Figure 13: Front Panel Fastening Screws

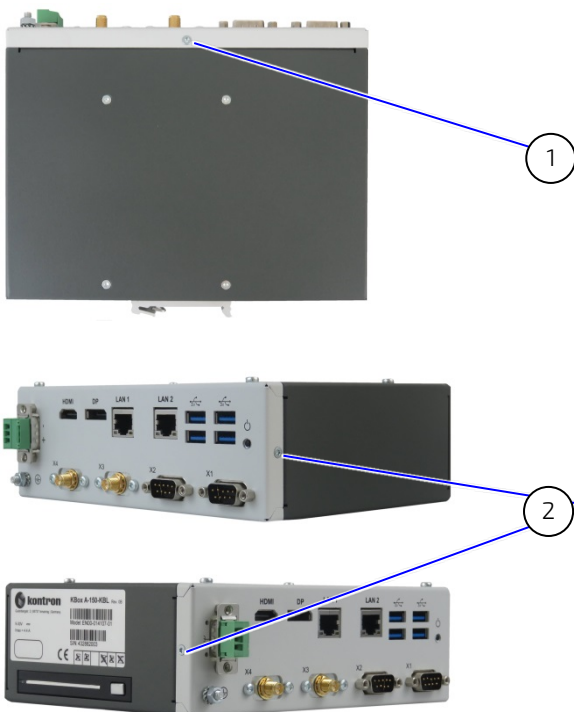

- 1 1x Flathead (M2 5x6) screw
- 2 2x Flathead (M2 5x6) screw (right side & left side)

- Carefully slide the front panel-SBC assembly out of the main chassis while taking care not to damage the SBC and internal components. When removing the front panel-SBC assembly ensure that internal cables do not catch on internal components.

Figure 14: Removing the Front panel- SBC Assembly

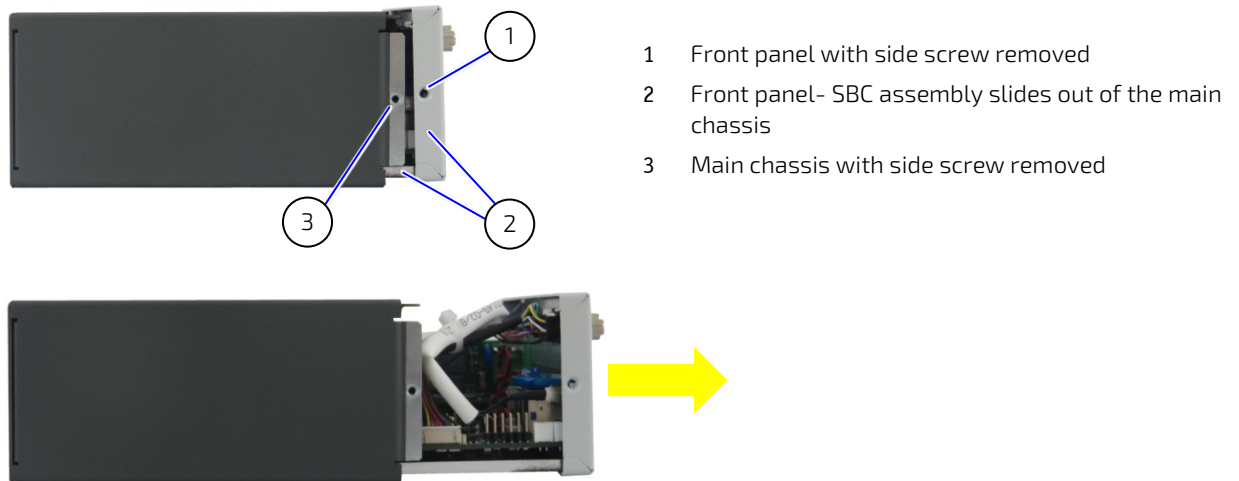

- Place the front panel- SBC assembly on an ESD-safe surface.
- Close the system, by proceeding in the reverse order. Align the front panel- SBC assembly with the open chassis. Carefully slide the front panel- SBC assembly towards the rear side of the chassis, while taking care that the internal cables have space and do not catch on or damage internal components. Secure using the screws retained in step 3 and 4.



## 6.3. Installing and Removing M.2 SSD Card

### NOTICE

#### Protection label

The KBox A-150-KBL is factory configured to meet customer requirements and then sealed with a protection label. Opening the KBox A-150-KBL invalidates the warranty and may cause damage to internal components.

Figure 15: M.2 Module on the SBC

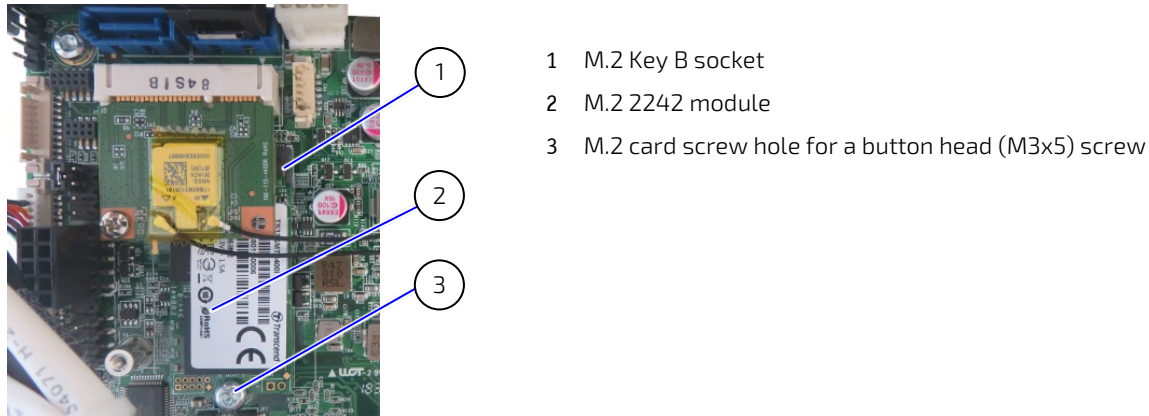

- 1 M.2 Key B socket
- 2 M.2 2242 module
- 3 M.2 card screw hole for a button head (M3x5) screw

To install a M.2 SSD module, perform the following:

1. Open the system as described in Chapter 6.2: Opening the System (steps 1-6).
2. Place the system on a flat, clean and ESD-safe surface.
3. Locate the M.2 socket and the corresponding fastening screw hole.
4. Insert the M.2. SSD module into the M.2 socket, at an angle (approx. 30°). If required move the module slightly from side to side to ease the module carefully into the socket.
5. Push down on the M.2 SSD module's free end until the module's screw hole aligns with the screw hole on the SBC.
6. Secure the M.2 SSD module by carefully tightening the fastening screw with a torx (M3x5) screwdriver until the module is flat with the SBC.
7. Close the system as described in Chapter 6.2: Opening the System (step 7).

To remove a M.2 SSD module, perform the following:

1. Open the system as described in Chapter 6.2: Opening the System (steps 1-6).
2. Place the system on a flat, clean and ESD-safe surface.
3. Locate the installed M.2 SSD module.
4. Use a torx (M3x5) screwdriver to remove the module's fastening screw. The module springs up at the free end.
5. Gently pull the M.2 SSD module out of the M.2 socket. If required move the module slightly from side to side to ease the module carefully out of the socket. Retain the fastening screw for later use.
6. Close the system as described in Chapter 6.2: Opening the System (step 7).

### WARNING

After changing the M.2 SSD, the partitioning of the memory may differ and require repartitioning.



## 6.4. Installing and Removing mPCIe Expansion Cards

### NOTICE

#### Protection label

The KBox A-150-KBL is factory configured to meet customer requirements and then sealed with a protection label. Opening the KBox A-150-KBL invalidates the warranty and may cause damage to internal components.

Figure 16: mPCIe Expansion Card on the SBC

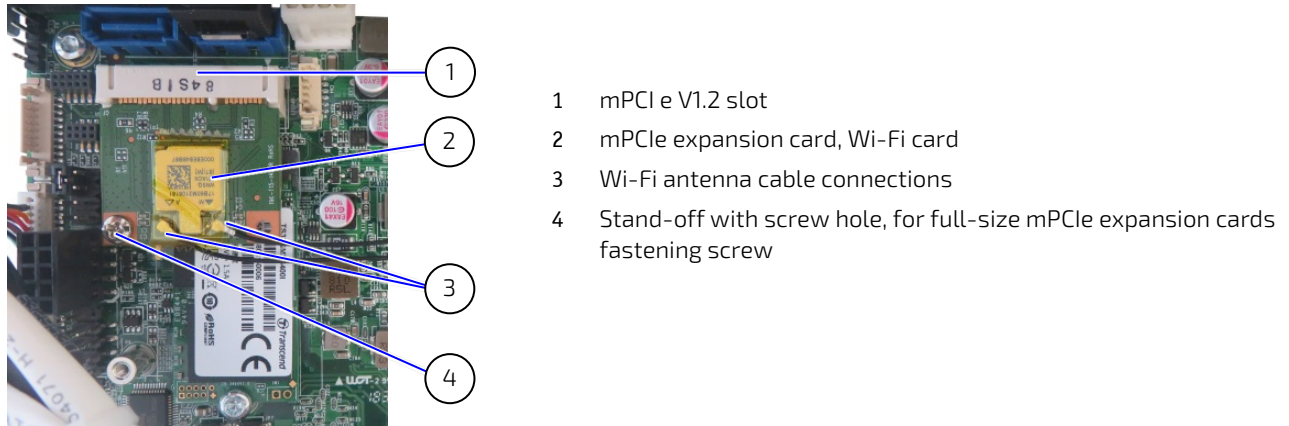

To install a mPCIe card, perform the following:

1. Open the system as described in Chapter 6.2: Opening the System (step 1-6).
2. Place the system on a flat, clean and ESD-safe surface.
3. Locate the mPCIe card slot and the corresponding fastening screw hole.
4. Insert the mPCIe card into the slot at an angle (approx. 30°). If required move the card slightly from side to side to ease the card carefully into the slot.
5. Push down on the mPCIe cards free end until the card's screw hole aligns with the screw hole on the SBC.
6. Secure the mPCIe card by carefully tightening the fastening screw until the card is flat with the SBC.
7. Close the system as described in Chapter 6.2: Opening the System (step 7).

To remove an mPCIe card, perform the following:

1. Open the system as described in Chapter 6.2: Opening the System (step 1-6).
2. Place the system on a flat, clean and ESD-safe surface.
3. Locate the installed mPCIe card.
4. Use a torx (M3x5) screwdriver to remove the mPCIe card's fastening screw. The card springs up at the free end.
5. Gently pull the mPCIe card out of the slot. If required move the card slightly from side to side to ease the card carefully out of the slot. Retain the fastening screw for later use.
6. Closed the system as described in Chapter 6.2: Opening the System (step 7).

## 7/ Thermal Considerations

The KBox A-150-KBL is fanless and passively cooled using a heatsink plate or optional heatsink. The heatsink plate and optional heatsink absorb the heat produced by the internal components and transfers the heat away from the internal components by dissipating the heat into the ambient environment.

### **⚠ WARNING**

#### Hot Surface

Heatsinks can get very hot. To avoid burns and personal injury:

- Do not touch the heatsink when in operation
- Allow the product to cool before handling
- Wear protective gloves
- Always turn the product off when not in use

### 7.1. Heatsink Plate

When mounting in a DIN rail control cabinet take care not to obstruct the airflow over the heatsink plate, as this can stop sufficient heat dispersing into the ambient environment and cause a build-up of heat.

The heatsink plate dimensions are:

- ▶ 171 mm (6.7") x 105 mm (4.1" )

### 7.2. Heatsink (option)

The heatsink is installed on top of the heatsink plate. It is possible to rotate the heatsink by 90° to enable the heatsink to remain in the vertical position to support vertical airflow within a DIN rail control cabinet. The DIN rail clamp can be installed directly on the top of the heatsink, see Figure 17.

Figure 17: Heatsink and Heatsink with DIN Rail Clamp



Heatsink



Heatsink with DIN rail clamp

When mounting in a DIN rail control cabinet, take care not to obstruct the airflow over the heatsink. Obstructing the airflow can stop sufficient heat dispersing into the ambient environment and causes a build-up of heat.

The heatsink dimensions are:

- ▶ 130 mm (5.12"), 130 mm (5.12"), 19.2 mm (0.76")

For additional heatsink mechanical information, see Chapter 10.3.1.1: Mechanical Diagrams Heatsink.



The Heatsink Kit's part number is EN05-100003-01.

## 8/ Installation Instructions



Due to possible access restrictions, before installing in a control cabinet ensure that the system is configured as required. If access to the front panel is restricted, connect peripherals to the corresponding system ports before installation.

### 8.1. DIN Rail Mounting

The KBox A-150-KBL is mounted on a DIN Rail in a control cabinet using a DIN rail clamp assembled on either the:

- ▶ Top side of the chassis
- ▶ Heat sink on the top side of the chassis
- ▶ Rear side of the chassis

The position and direction of the DIN rail clamp decides the orientation of the KBox A-150-KBL within the control cabinet. Therefore, when installing the DIN rail clamp take the following into consideration:

- ▶ Do not obstruct the airflow over the heatsink, this can stop sufficient heat dispersing and causes a build-up of heat.
- ▶ Access to the front panel I/O connectors, power connector and external drive bay

To attach the DIN rail clamp, perform the following:

1. Make sure that the DIN rail clamp is in the upper position, for the required mounting option.

Figure 18: DIN Rail Clamp Upper Position



2. Fasten the DIN rail clamp firmly using the supplied two flathead (M4x6) screws only.

Figure 19: DIN Rail Clamp Screw Dimensions (mm)

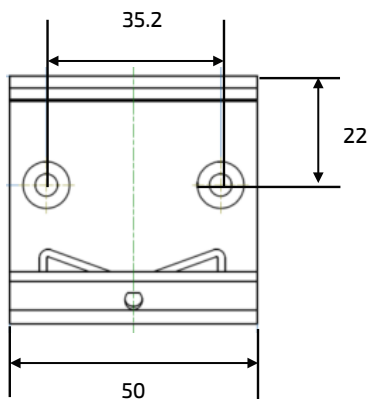

3. Clip the top of the DIN rail mounting in to the DIN rail and push the bottom of the DIN rail clamp firmly until it clamps on to the bottom of the DIN rail.

## 8.2. Control Cabinet Mounting

For sufficient air circulation around the KBox A-150-KBL, Kontron recommends users not to place, mount or operate any other devices within the specified keep out areas around the KBox A-150-KBL.

Users must observe the marked keep out areas shown in Figure 20, Figure 21, Figure 22, Figure 23 and Figure 24.

Figure 20: Keep Out Area for Mounting for KBox A-150-KBL (with external 2.5" HDD/SSD drive bay)

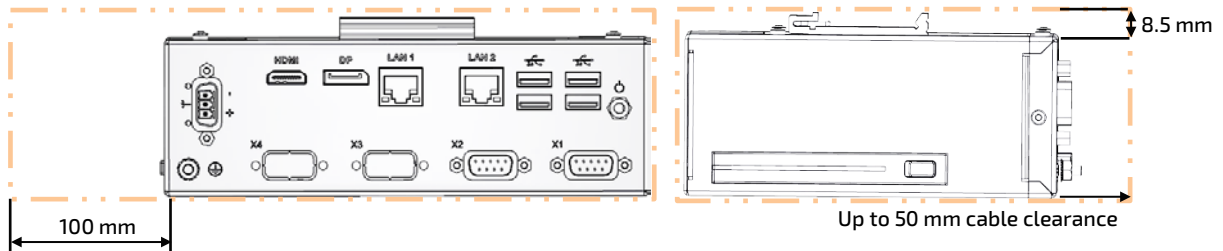

Figure 21: Keep Out Area for Mounting for KBox A-150-KBL (with no drive bay)

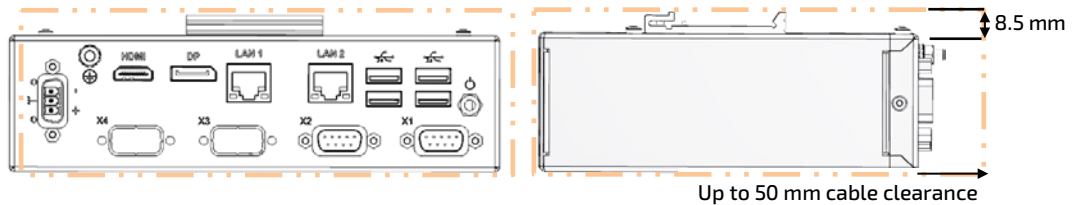

Figure 22: Keep Out Area for Mounting for KBox A-150-KBL (with heatsink & external 2.5" HDD/SSD drive bay)

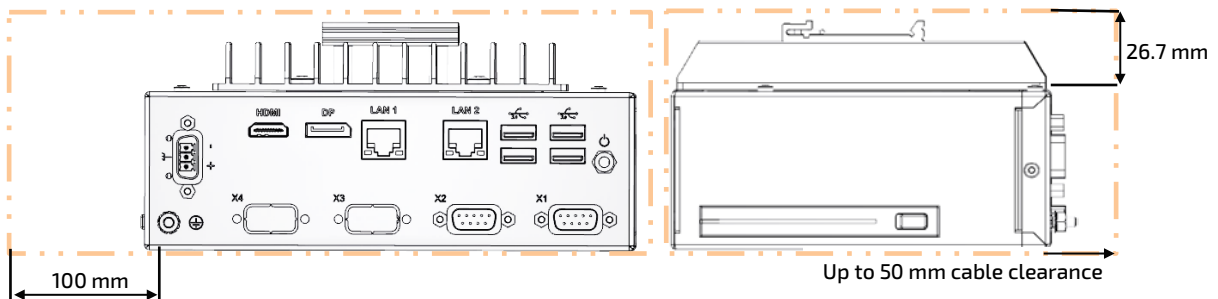
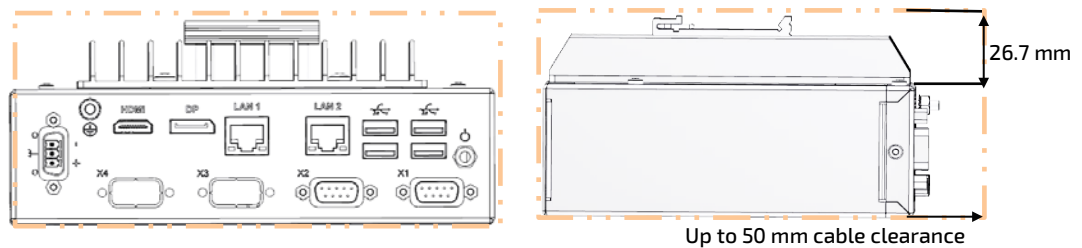

Figure 23: Keep Out Area for Mounting for KBox A-150-KBL (with heatsink & no drive bay)



The cable clearance depends on the installed connectors types.

For the KBox A-150-KBL with Wi-Fi, the front panel keep out area depends on the implemented dual Wi-Fi antennas and the orientation of the Wi-Fi antennas.

Figure 24: Keep Out Area for installed dual Wi-Fi Antenna (with external 2.5" HDD/SSD drive bay)

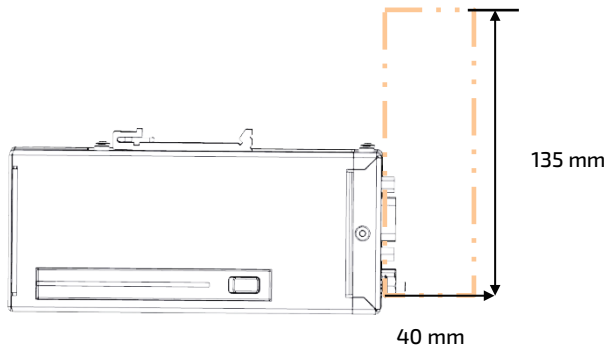

Wi-Fi antennas require an additional keep out area. Kontron's reference Wi-Fi antennas require a minimum of 40 mm horizontally and 135 mm in required antenna direction when measured from the Wi-Fi connector.

### 8.3. Wiring the Mating Power Connector/Terminal

The input power connector connects to a DC power supply using the supplied mating power connector/terminal (PSC 1.5/ 3-F) and the corresponding wiring. The wiring is inserted into the mating power connector/terminal's clamps, see Figure 25, pos. 4, 5 & 6 and must be clearly marked (+/-/functional earth) to ensure proper connection to the DC power supply.

The wiring is not part of the delivery und must be provided by the user.

- ▶ Use copper conductors only if the field wiring terminal is only for connection to copper wire.
- ▶ Minimum temperature rating of the cables connected to the field wiring terminals is 75° C.

Figure 25: Input Power Connector and Mating Power Connector/Terminal

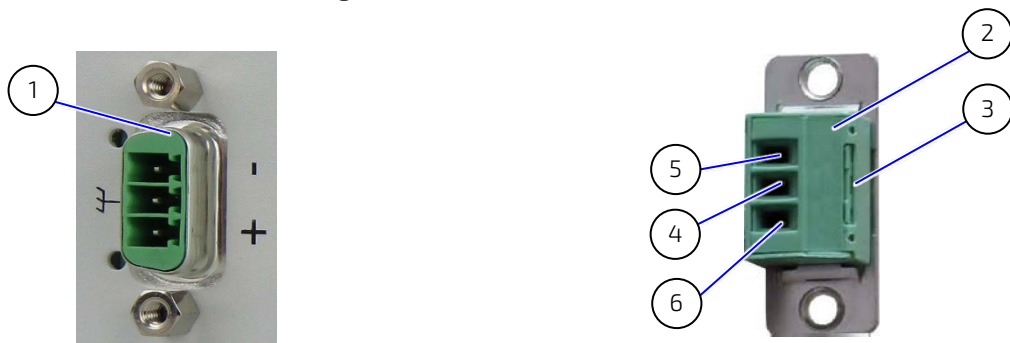

- |  |                                   |
|--|-----------------------------------|
| 1 3-pin input power connector (PSC 1,5/ 3-M)           | 4 Clamp for functional earth wire |
| 2 3-pin mating power connector/terminal (PSC 1,5/ 3-F) | 5 Clamp for 0 VDC wire            |
| 3 Cover over the slotted pan head screws               | 6 Clamp for +24 VDC wire          |

To wire the supplied mating power connector/terminal (PSC 1,5/ 3-F), perform the following:

1. Cut three (1 mm<sup>2</sup>) AWG18 isolated wires to the required length and strip each end 5 mm – 7 mm.
2. Twist the striped wire-ends and provide them with ferrules.
3. Access the slotted pan head screws by opening the mating power connector/terminal's cover (Figure 25, pos. 3).
4. Loosen the slotted pan head screws far enough so that you can insert the end of the prepared wires.
5. Insert the wires into the corresponding clamp of the mating power connector/terminal. Make sure that you have the right polarity of the connection. For the pin assignment of the input power connector, see Chapter 11.1.1: Input Power Connector.
6. Fasten the screws to secure the wires into the mating power connector/terminal's clamps.
7. Close the mating power connector/terminal's cover (Figure 25, pos. 3).

---

**NOTICE**

Mark the wires clearly as (+/-/functional earth) to ensure a safe connection from the input power connector to the DC power supply.

---

---

**NOTICE**

Support the power and I/O cables to minimize the strain on the product's connectors.

---

## 9/ Switching On

Before switching on, observe the instructions in Chapter 1/: General Safety Instruction and the instructions within this chapter.

### 9.1. Connecting to a DC Power Supply

#### **CAUTION**

Observed that wiring and short-circuit/overcurrent protection is performed according to the applicable standards, regulations and in respect to the product's electrical specification. The disconnecting device (fuse/circuit breaker) rating must be in accordance with the product wire cross-section.

#### **CAUTION**

Even when switched off using the power-on switch, parts of the system are still energized. The product is only completely switched off when the power has been switched off using the power-on switch and the power cable is disconnected from either the DC power supply or the Input power connector.

#### **NOTICE**

Following a proper cabling procedure prevents a false power-on condition, that could result in operational failure. When installing/disconnecting the product ensure that:

- The functional earth connection is made first and disconnected last.
- The last connection made to the product is the power wiring.

#### **NOTICE**

The wires used for power connections must be marked clearly (+/-/functional earth) to ensure a safe connection from the input power connector to the DC power supply.

#### **NOTICE**

Support the power and I/O cables to minimize the strain on the product's connectors.

#### **NOTICE**

Do not disconnect the power while the product is switched on! This performs a forced shutdown and can lead to loss of data. To shutdown without data loss, switch off using the Power-on switch.

To connect to the external DC power supply, perform the following:

1. Wire the supplied mating power connector/terminal (PSC 1.5/3-F) as described in, see Chapter 8.3:Wiring the Mating Power Connector/Terminal.
2. Switch off the external DC power supply via a disconnecting device (fuse/circuit breaker), to ensure that no power flows during the connection procedure.
3. Connect the protective earth stud bolt to an appropriate common earth connection.
4. Connect the wired mating power connector/terminal (PSC 1.5/3-F) to the input power connector. Pay attention to the polarity of the connections, see Chapter 11.1.1: Input Power Connector.
5. Connect the other end of the wired mating power connector/terminal to the external DC power supply.



Once connected to an external DC power supply the KBox A-150-KBL can be switch on and switch off using the front panel power-on switch.

## 9.2. Switch On

To switch on while the KBox A-150-KBL is connected to the DC power supply, perform the following:

1. Press the Power-on switch, see Figure 3 and Figure 4, pos. 7.
2. The system switches on.

### NOTICE

---

Do not disconnect the power while the product is switched on. This performs a forced shutdown and can lead to loss of data. To shutdown without data loss, switch off using the Power-on switch

---

## 9.3. Switch Off

To switch off the KBox A-150-KBL without performing a force shutdown, perform the following:

1. Press the Power-on switch, see Figure 3 and Figure 4, pos.7.
2. The system performs an orderly shutdown.
3. If required, completely switch off by disconnecting the power connection at the Input power connector or the DC power supply.

### CAUTION

---

Even when switched off using the power-on switch, parts of the product are still energized. The product is only completely switched off when the power has been switched off using the power-on switch and the power wiring is disconnected from either the DC power supply or the Input power connector.

---

### NOTICE

---

Do not disconnect the power while the product is switched on. This performs a forced shutdown and can lead to loss of data. To shutdown without data loss, switch off using the Power-on switch.

---

## 9.4. Operating System (OS) and Drivers

The KBox A-150-KBL comes factory configured, with a pre-installed Operating System (OS) and all the necessary drivers (in accordance with the ordered hardware configuration). The KBox-A-150-KBL is full operation when switched on for the first time.



---

To download relevant drivers for the factory installed hardware components visit [Kontron's Customer Section](#).

---



---

Pay attention to the manufacturer OS specifications relating to the integrated hardware components.

---



# 10/ Technical Data

## 10.1. Block Diagram

Figure 26: Block Diagram

### KBox A-150-KBL

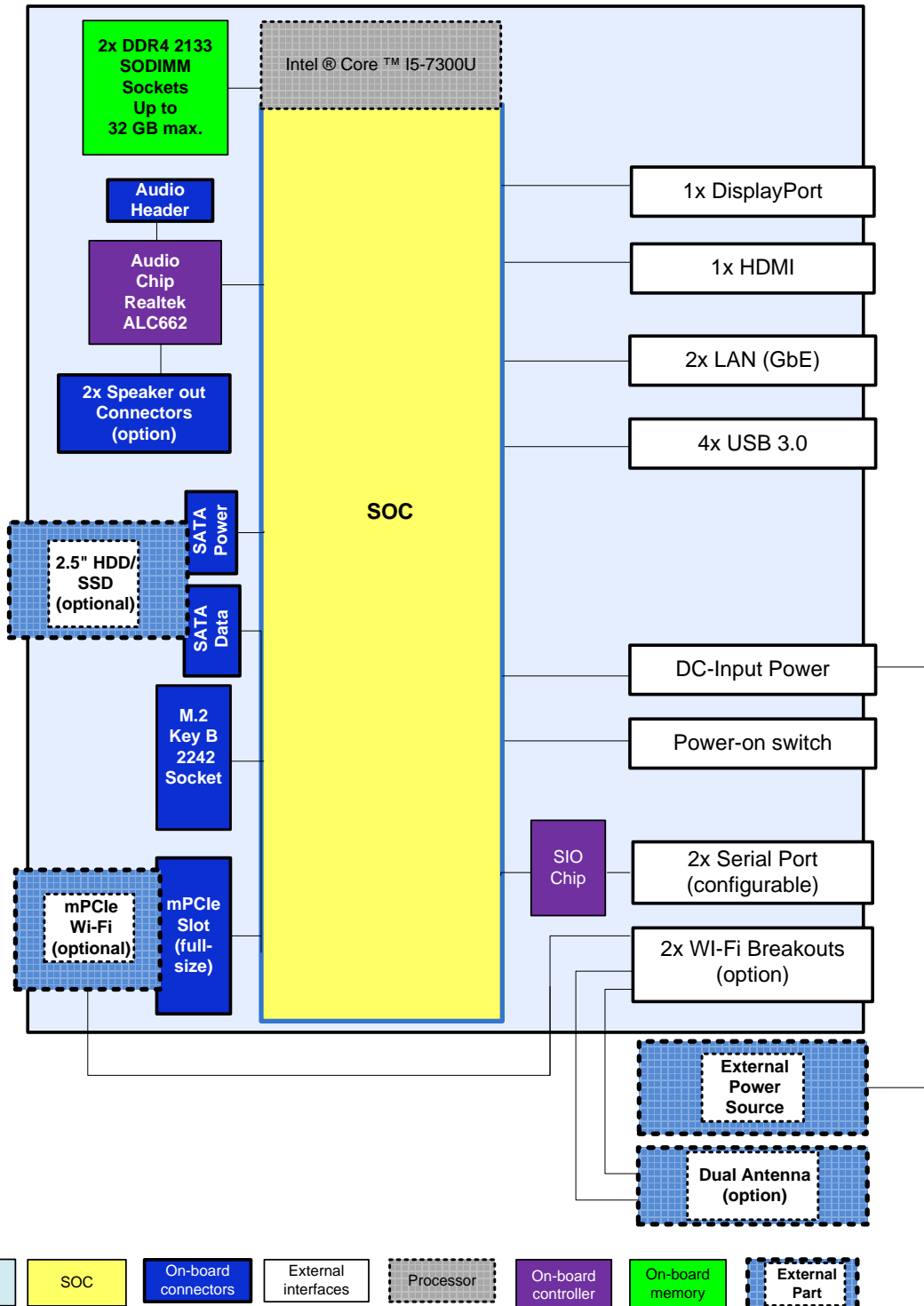

## 10.2. Technical Specification

Table 7: Technical Specification

|                              |  |
|------------------------------|--|
| <b>Processor Board</b>       | ECX-KLU0<br>3.5" ECX Single Board Computer (SBC)   |
| <b>Processor</b>             | Intel® Core™ i5-7300U<br>2.6 GHz/3.5 GHz (burst)   |
| <b>System Memory</b>         | 2x DDR4 2133 SODIMM<br>Up to 32 GB max.  |
| <b>Interfaces</b>            | 4x USB 3.0 (Type A)<br>2x GbE LAN (1x Intel® I219-LM, 1x Intel® I210-AT)<br>1x HDMI 2.0<br>1x DP<br>2x COM ( RS232, RS422, RS485, BIOS configurable)<br>1x power on switch |
| <b>Storage</b>               | 1x M.2 2242 SSD module Key B, mixed w/USB2.0 or SATA<br>Up to 512 GB max.<br>1x 2.5" slim HDD/SSD drive (option) <sup>[1]</sup>  |
| <b>Audio</b>                 | Line-In/Line-Out/Mic via Audio connector (option)  |
| <b>Expansion Slots</b>       | 1x mPCIe V1.2 (full-size)  |
| <b>Lithium Battery</b>       | CR 2032, 3 V   |
| <b>Power</b>                 | 9 VDC to 30 VDC input range<br>4.4 A Input current max.<br>24 VDC nominal input voltage  |
| <b>IP Protection Class</b>   | IP 40  |
| <b>Operating System (OS)</b> | Windows 10 IoT Enterprise 2016 LTSB<br>Linux   |
| <b>BIOS</b>                  | AMI uEFI BIOS, Aptio V5  |

<sup>[1]</sup> Only possible for KBox A-150-KBL variants with externally 2.5" HDD/SSD drive bay

### 10.3. Mechanical Specification

Table 8: Mechanical Specification

| Dimensions            | KBox A-150-KBL<br>(with HDD/SSD Drive Bay)  | KBox A-150-KBL<br>(without HDD/SSD Drive Bay) |
|-----------------------|---|---|
| Width                 | 180 mm (7.09")  |   |
| Depth                 | 134 mm (5.28")  |   |
| Height                | 58 mm (2.28")   | 50 mm (1.97")                                 |
|                       | 76 mm (2.99") with heatsink   | 68 mm (2.68") with heatsink                   |
| Weight (chassis only) | Approx. ~1 kg (~2.2 lbs.)   |   |
| Construction          | Steel chassis   |   |
| Mounting              | DIN Rail  |   |
| Color                 | RAL7035 (front panel)<br>RAL7043 (top cover and main chassis)<br>Black (heatsink) |   |

#### 10.3.1. Mechanical Diagrams

For detailed mechanical information, refer to the outline dimension diagrams in this chapter showing the main external mechanical dimensions.

The following outline dimension drawings show the features for the KBox A-150-KBL with an external 2.5" HDD/SSD drive bay.

Figure 27: Front Panel Dimensions with External 2.5" HDD/SSD Drive Bay (mm)

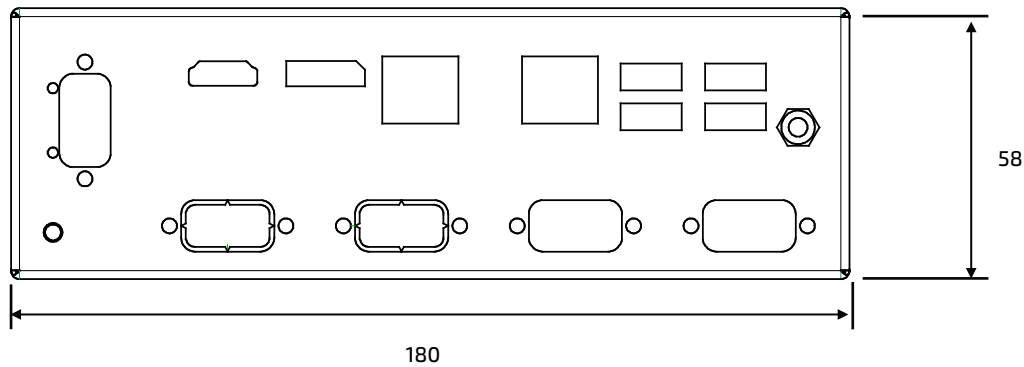

Figure 28: Rear Side Dimensions with External 2.5" HDD/SSD Drive Bay (mm)

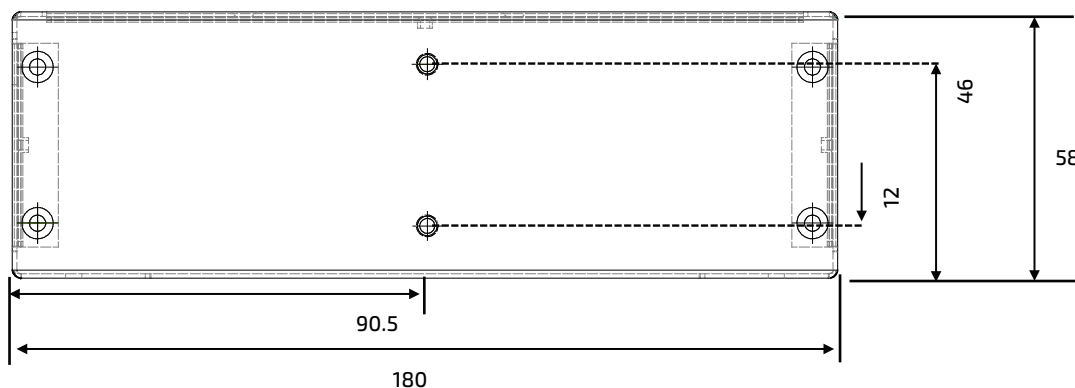



Figure 32: Rear Side Dimensions without Drive Bay (mm)

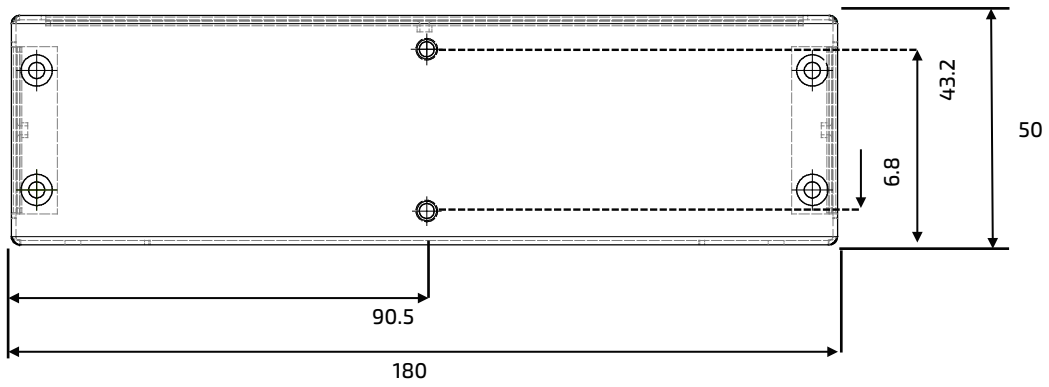

Figure 33: Top Side Dimensions without Drive Bay (mm)

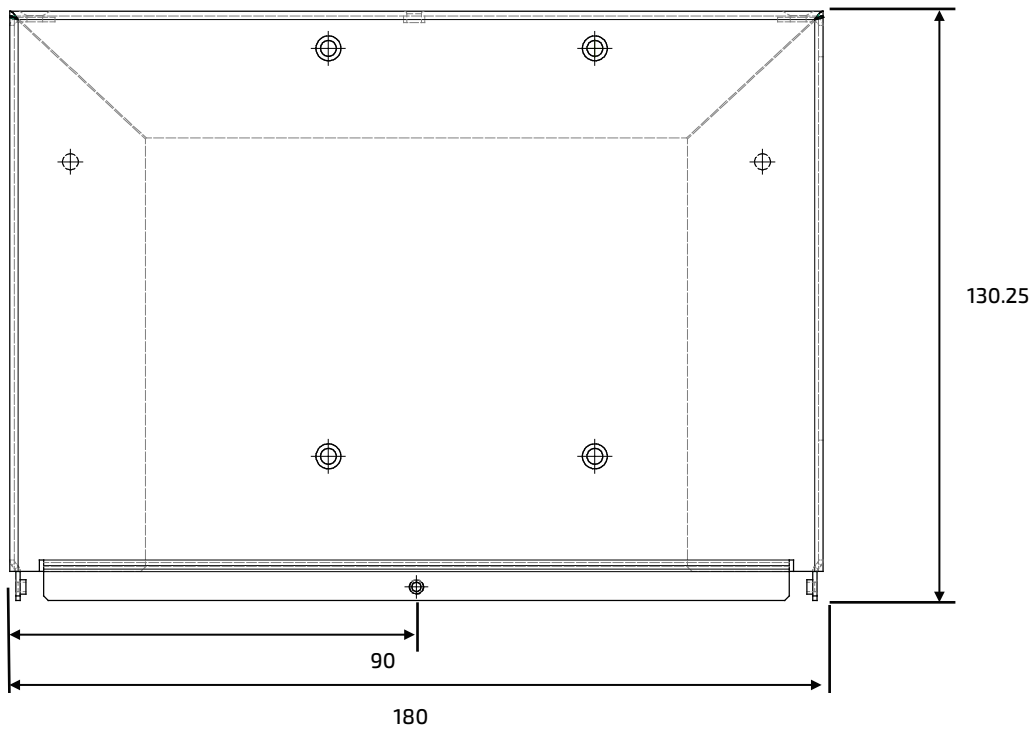
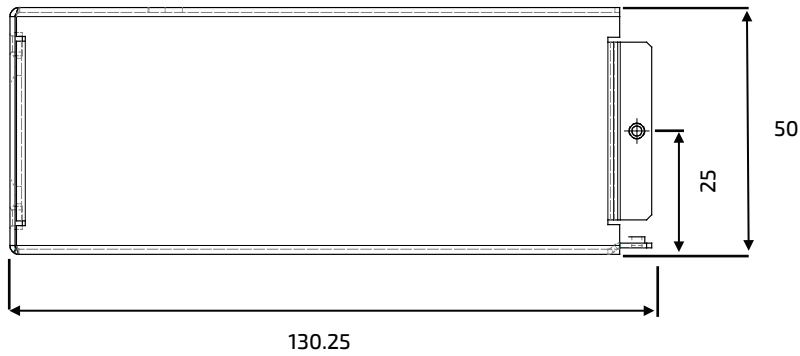

Figure 34: Side View Dimensions without Drive Bay (mm)



### 10.3.1.1. Mechanical Diagrams Heatsink

The following outline dimension drawings show the features of the optional heatsink with DIN rail mounting holes.

Figure 35: Mechanical Diagram Heatsink (mm)

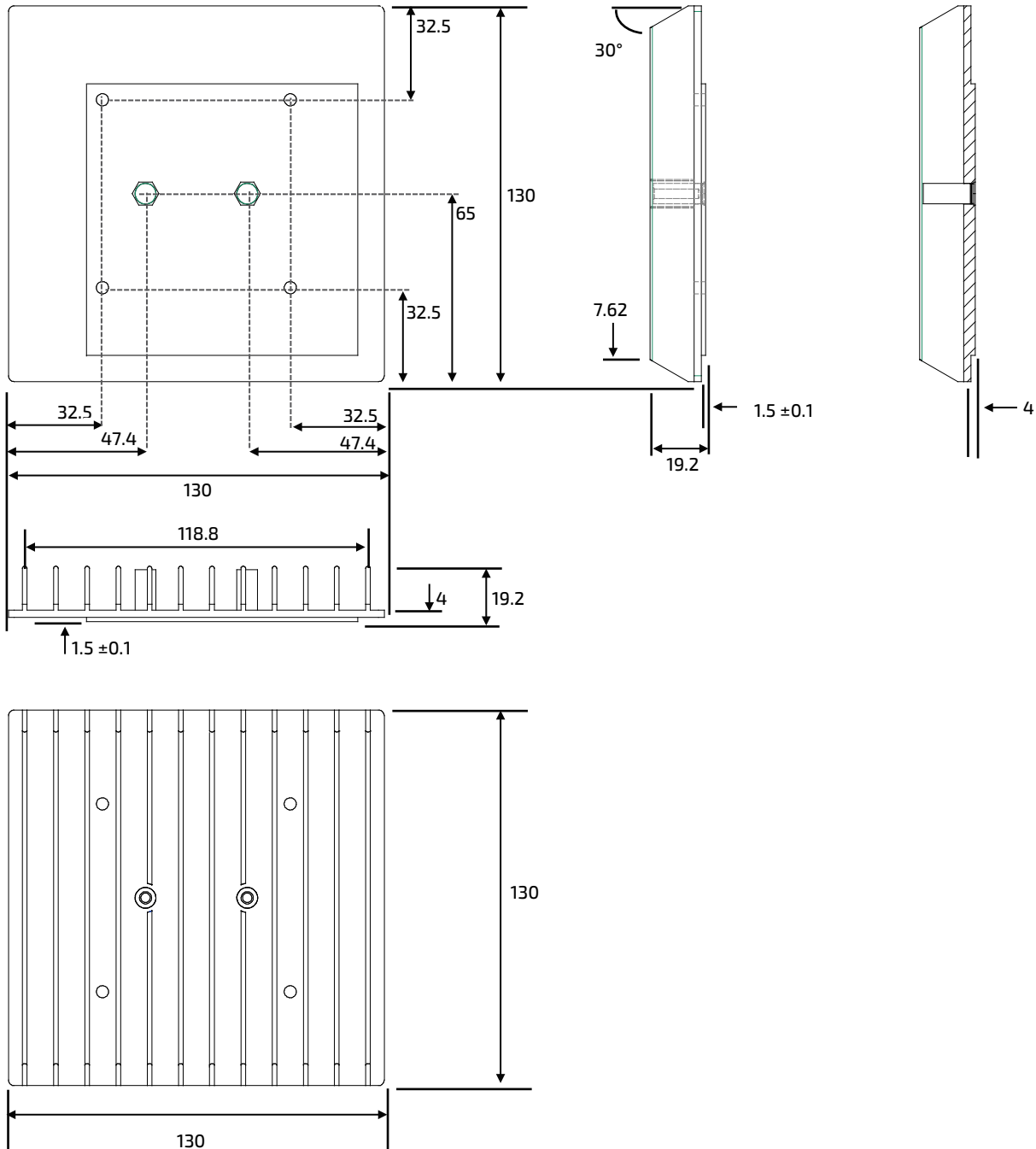

## 10.4. Environmental Specification

Table 9: Environmental Specification

| Temperature               |                   | Description                                    |
|---------------------------|-------------------|--|
| Temperature               | Operating         | 0°C to 40°C ambient (up to 50°C with heatsink) |
|                           | Storage & Transit | -20°C to 60°C ambient                          |
| Relative Humidity         | Operating         | 10%-90% RH @ 39°C, non condensing              |
| Environmental             |                   | Description                                    |
| Shock<br>EN 60068-2-27    | Operating         | Half sine, 15 g, 11 ms                         |
|                           | Storage & Transit | Half sine, 30 g, 11 ms                         |
| Vibration<br>EN 60068-2-6 | Operating         | 5 to 500 Hz, 1.0 g, 3 axis                     |
|                           | Storage & Transit | 10 to 500 Hz, 2.0 g, 3 axis                    |
| Altitude                  |                   | Up to 2,000 m (operating)                      |
| Cooling                   |                   | Fanless passive cooling                        |

## 10.5. Compliance

The KBox A-150-KBL complies with the relevant requirements and the approximation of the laws relating to 'CE' (for no Wi-Fi variant) and 'RED' (for Wi-Fi variant), and the standards that are constitutional parts of the declaration.

**Table 10: KBox A-150-KBL without Wi-Fi - Standards, Certifications and Directives Compliance**

| <b>CE</b>                           |   |  |
|-------------------------------------|---|--|
| Electromagnetic Compatibility (EMC) |   | Directive 2014/30/EU   |
| General Product Safety              |   | Directive 2001/95/EC   |
| Low Voltage                         |   | Directive 2014/35/EU   |
| <b>EMC</b>                          |   |  |
| Emission (Class B)                  | EN55032<br>CISPR 32: Edition 2          | Complies with the electromagnetic compatibility of multimedia equipment - emissions requirements   |
| Immunity                            | EN55024<br>CISPR 24                     | Complies with the information technology equipment - Immunity characteristics, limits and methods of measurement   |
| <b>Safety</b>                       |   |  |
| Europe                              | EN 61010-1                              | Safety requirements for electrical equipment for measurement, control and laboratory use - Part 1: General requirements  |
| CB Scheme                           | CB certificate<br>IEC/EN/UL 61010-1     | Safety requirements for electrical equipment for measurement, control and laboratory use - Part 1: General requirements  |
|                                     | CB certificate<br>IEC/EN/UL 61010-2-201 | Safety requirements for electrical equipment for measurement, control and laboratory use - Part 2-201: Particular requirements for control equipment   |
| <b>FCC</b>                          |   |  |
| FCC 47 CFR Part 15 (Class B)        |   | Complies with part 15 FCC rules and regulations of title 47 of the CFR rules for class B products; under which an unintentional radiator may be operated, administrated and other conditions relating to the marketing of part 15 devices.             |
| ICES-003                            |   | Information technology equipment - Radio disturbance characteristics, limits and methods of measurement ICES-003:2016 rules to limit the potential of harmful interference.  |
| <b>Environment</b>                  |   |  |
| WEEE                                |   | Compliant with the Waste Electrical and Electronic Equipment (WEEE) 2012/19/EU directive; to reduce waste of electrical and electronic equipment, encourage recycling and environmental disposal and increase the environmental awareness of producers |
| RoHS II                             |   | Compliant with the Restriction of Hazardous Substances (RoHS) 2011/65/EU directive or the late status thereof, to reduce hazardous substances in electrical and electronic equipment   |

**Table 11: KBox A-150-KBL with Wi-Fi - Standards, Certifications and Directives Compliance**

| <b>RED Directive 2014/53/EU</b>                       |   |
|---|---|
| Draft ETSI<br>EN 301 489-01 V2.2.0<br>(2017-03)       | EMC standard for radio equipment and services; Part 1: Common technical requirements; Harmonized standard for Electromagnetic compatibility   |
| Final Draft ETSI<br>EN 301 489-17 V3.2.0<br>(2017-03) | EMC standard for radio equipment and services - part 17: Specific conditions for Broadband Data Transmission Systems; Harmonized Standard covering the essential requirements of article 3.1(b) of Directive 2014/53/EU |
| ETSI EN 300 328 V2.2.1<br>(2016-11)                   | Wideband transmission systems; Data transmission equipment operating in the 2,4 GHz ISM band and using wide band modulation techniques; Harmonized Standard for access to radio spectrum                                |



| RED Directive 2014/53/EU         |  |  |
|----------------------------------|--|--|
| ETSI EN 301 893 V2.1.1 (2017-11) | 5 GHz RLAN; Harmonized Standard covering the essential requirements of article 3.2 of Directive 2014/53/EU   |  |
| EMC                              |  |  |
| Emission (Class B)               | EN55032<br>CISPR 32: Edition 2   | Complies with the electromagnetic compatibility of multimedia equipment - emissions requirements   |
| Immunity                         | EN61000-6-2  | Electromagnetic compatibility (EMC) - Part 6-2: Generic standards- Immunity for industrial environment   |
| Safety                           |  |  |
| Europe                           | EN 61010-1   | Safety requirements for electrical equipment for measurement, control and laboratory use - Part 1: General requirements                              |
| CB Scheme                        | CB Certificate<br>IEC/EN/UL 61010-1  | Safety requirements for electrical equipment for measurement, control and laboratory use - Part 1: General requirements                              |
|                                  | CB Certificate<br>IEC/EN/UL 61010-2-201  | Safety requirements for electrical equipment for measurement, control and laboratory use - Part 2-201: Particular requirements for control equipment |
| FCC                              |  |  |
| FCC 47 CFR Part 15 (Class B)     | Complies with part 15 FCC rules and regulations of title 47 of the CFR rules for class B products; under which an unintentional radiator may be operated, administrated and other conditions relating to the marketing of part 15 devices.             |  |
| ICES-003                         | Information technology equipment – Radio disturbance characteristics, limits and methods of measurement ICES-003:2016 rules to limit the potential of harmful interference.  |  |
| Environment                      |  |  |
| WEEE                             | Compliant with the Waste Electrical and Electronic Equipment (WEEE) 2012/19/EU directive; to reduce waste of electrical and electronic equipment, encourage recycling and environmental disposal and increase the environmental awareness of producers |  |
| RoHS II                          | Compliant with the Restriction of Hazardous Substances (RoHS) 2011/65/EU directive or the late status thereof, to reduce hazardous substances in electrical and electronic equipment   |  |



---

If the product is modified, the prerequisites for specific approvals may no longer apply.

---



---

Kontron is not responsible for any radio television interference caused by unauthorized modifications of the delivered product or the substitution or attachment of connecting cables and equipment other than those specified by Kontron. The correction of interference caused by unauthorized modification, substitution or attachment is the user's responsibility.

---



---

The use of shielded I/O cables is required when connecting to peripheral or host devices. Failure to do so may violate FCC/ICES rules.

---

## 10.6. Power Specification

Before connecting the product to a DC power supply, ensure that the power supply meets the required electrical specification for the product and that protection and supply limitation have been taken into consideration. Additionally, the power supply used must automatically recover from AC power loss and start up under peak loading.

Connect the product only to a power supply designed to achieve NEC Class-2 and Limited Power Source (LPS).

Table 12: Power Specification

|                         |                           |
|-------------------------|---------------------------|
| Input Voltage (nominal) | 24 VDC                    |
| Input Voltage (range)   | 9 VDC to 30 VDC           |
| Input Current           | 4.4 A (max.)              |
| Inrush Current          | 6 A                       |
| Input Power Connector   | 3-pin Phoenix PSC 1.5/3-M |

### ⚠ CAUTION

Observed that wiring and short-circuit/overcurrent protection is performed according to the applicable standards, regulations and in respect to the product's electrical specification. The disconnecting device (fuse/circuit breaker) rating must be in accordance with the product's wire cross-section.

### ⚠ CAUTION

Only connect to an external power supply delivering the specified input rating and complying with the requirements of Safety Extra Low Voltage (SELV) and Limited Power Source (LPS) of UL/IEC 60950-1 or (PS2) of UL/IEC 62368-1.

### NOTICE

Ensure that the power supply is used according to the manufacturer's instructions.

### NOTICE

Ensure the power supply has been fully tested to at least meet the minimum immunity of AC inputs requirements, as stipulated in IEC 55024. Including power supplies marketed with a separate AC/DC power converter.

### NOTICE

Do not disconnect the power from the system while the system is switched on!  
Performing a forced shut down can lead to loss of data or other undesirable effects!

### 10.6.1. Power Supply Protection Requirements

The used external power supply is required to incorporate protection and supply features such as over current protection, inrush current protection, over voltage protection and under voltage (brownout) protection, to protect the product against fluctuations and interruptions in the delivered DC power supply.

### NOTICE

If an under voltage (brownout) condition occurs the used power supply must remain in the "off state" long enough to allow internal voltages to discharge sufficiently. Failure to observe this "off state" may mean that parts of the product or peripherals work incorrectly or suffer a reduction of MTBF. The minimum "off state", to allow internal voltages to discharge sufficiently, is dependent on the power supply and additional electrical factors. To determine the required "off state", each case must be considered individually. For more information, contact [Kontron Support](#).

## 10.6.2. Power Consumption

The total power consumption depends on factors such as the capacity of the SBC, external interfaces and system expansion. Use an appropriate PSU that is able to supply the power required by all configured components.

**Table 13: Power Consumption**

| Power Consumption                   |                                |                             | Type Label Rating |                              |
|-------------------------------------|--------------------------------|-----------------------------|-------------------|------------------------------|
| SBC (Burn-In)                       | External Interfaces            | Total                       |                   |                              |
| 100% RAM,<br>100% CPU,<br>100% Disk | 4x USB 3.0<br>1x HDMI<br>1x DP | SBC+<br>External Interfaces | Voltage           | 9 VDC to 30 VDC (max. range) |
|                                     |                                |                             | Current           | 4.4 A (max.)                 |
| 15 W                                | 22.6 W                         | 37.6 W                      | Power             | 39.5 W (37.6 W + 5%)         |



---

The PSU must supply the power required by all KBox A-150-KBL configured components.

---

## 10.6.3. Protective Earth Stud Bolt

The protective earth stud bolt connects to the internal chassis GND. The protective earth stud bolt is located next to the Input Power connector at the bottom of the front panel when the external 2.5" HDD/SSD drive bay is included (Figure 3, pos. 2) and at the top of the front panel without an external drive bay (Figure 4, pos. 2).

When installing cables to the product the first cable connection must be to the protective earth stud bolt and when disconnecting the last cable to be disconnected must be from the protective earth stud bolt.

## 11/Connector Pin Assignments

### 11.1. Front Panel Connector Pin Assignments

#### 11.1.1. Input Power Connector (- +)

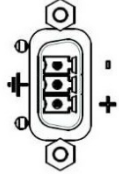
| 3-Pin Phoenix PSC 1.5/3-M Power Connector   | Pin | Signal Name      |
|---|-----|------------------|
|  | 1   | GND (-)          |
|   | 2   | Functional Earth |
|   | 3   | VCC (+)          |

#### 11.1.2. HDMI Connector (HDMI)

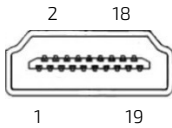
| 19-pin HDMI  | Pin | Signal Name | Pin | Signal Name     |
|--|-----|-------------|-----|-----------------|
|  | 1   | TMD Data2+  | 11  | GND             |
|  | 2   | GND         | 12  | TMD Clock-      |
|  | 3   | TMD Data2-  | 13  | CEC             |
|  | 4   | TMD Data1+  | 14  | Reserved        |
|  | 5   | GND         | 15  | DDC_CLK         |
|  | 6   | TMD Data1-  | 16  | DDC_DATA        |
|  | 7   | TMD Data0+  | 17  | GND             |
|  | 8   | GND         | 18  | +5V Power       |
|  | 9   | TMD Data0-  | 19  | Hot Plug Detect |
|  | 10  | TMD Clock+  |     |                 |

#### 11.1.3. Display Port Connector (DP)

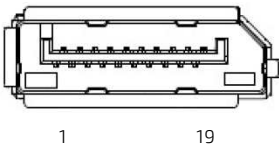
| 20-pin DP   | Pin | Signal Name | Pin | Signal Name |
|---|-----|-------------|-----|-------------|
|  | 1   | TX0+        | 11  | GND         |
|   | 2   | GND         | 12  | TX3-        |
|   | 3   | TX0-        | 13  | GND         |
|   | 4   | TX1+        | 14  | GND         |
|   | 5   | GND         | 15  | AUX+        |
|   | 6   | TX1-        | 16  | GND         |
|   | 7   | TX2+        | 17  | AUX-        |
|   | 8   | GND         | 18  | HPD         |
|   | 9   | TX2-        | 19  | GND         |
|   | 10  | TX3+        | 20  | PWR         |

### 11.1.4. GbE LAN RJ45 Connectors (LAN1, LAN2)

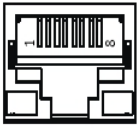
| RJ45 (female)   | Pin | Signal Name | Pin | Signal Name |
|---|-----|-------------|-----|-------------|
|  | 1   | MDIO+       | 5   | MDI2-       |
|   | 2   | MDIO-       | 6   | MDI1-       |
|   | 3   | MDI1+       | 7   | MDI3+       |
|   | 4   | MDI2+       | 8   | MDI3-       |

| Left LED: Speed |          | Right LED: Activity/Link |                     |
|-----------------|----------|--------------------------|---------------------|
| Off             | 10 Mbit  | Off                      | NO LAN connectivity |
| Green           | 100 Mbit | Yellow                   | Link                |
| Orange          | 1 GbE    | Blinking                 | Activity            |

### 11.1.5. USB 3.0 Port Connectors

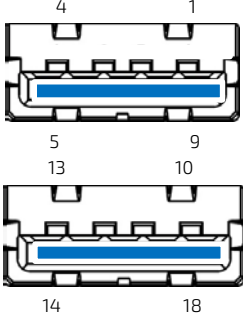
| USB Type A   | Pin | Signal Name              | Pin | Signal Name              |
|--|-----|--------------------------|-----|--------------------------|
|  | 1   | +USBA_VCC <sup>[1]</sup> | 10  | +USBB_VCC <sup>[1]</sup> |
|  | 2   | USBA_D-                  | 11  | USBB_D-                  |
|  | 3   | USBA_D+                  | 12  | USBB_D+                  |
|  | 4   | GND                      | 13  | GND                      |
|  | 5   | USBA_RX-                 | 14  | USBB_RX-                 |
|  | 6   | USBA_RX+                 | 15  | USBB_RX+                 |
|  | 7   | GND                      | 16  | GND                      |
|  | 8   | USBA_TX-                 | 17  | USBB_TX-                 |
|  | 9   | USBA_TX+                 | 18  | USBB_TX+                 |

<sup>[1]</sup>The power source of +USB\_VCC can be selected by JP7



For USB power selection information, see Chapter 11.2.11: USB Power Selection Jumper/SIM Card Jumper.

### 11.1.6. Serial Port Connectors (X1, X2)

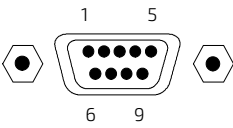
| 9-pin D-SUB (male)  | Pin | RS232 | RS422 | RS485 Half Duplex | RS485 Full Duplex |
|---|-----|-------|-------|-------------------|-------------------|
|  | 1   | DCD   | Tx-   | Data-             | Tx-               |
|   | 2   | RxD   | Tx+   | Data+             | Tx+               |
|   | 3   | TxD   | Rx+   |                   | Rx+               |
|   | 4   | DTR   | Rx-   |                   | Rx-               |
|   | 5   | GND   | GND   | GND               | GND               |
|   | 6   | DSR   |       |                   |                   |
|   | 7   | RTS   |       |                   |                   |
|   | 8   | CTS   |       |                   |                   |
|   | 9   | RI    |       |                   |                   |

## 11.2. SBC On-board Connector and Jumper Pin Assignments

Observe the procedures and instructions within this user guide when handling internal component.

### 11.2.1. Battery Power Input Connector

Connector for Kontron's RTC battery assembly.

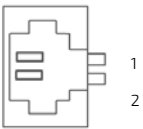
|   | Pin | Signal Name |
|---|-----|-------------|
|  | 1   | +VBAT       |
|   | 2   | GND         |

### 11.2.2. 12 VDC Out Power Connector

Connector supplies the internal components with a nominal input voltage of 12 VDC.

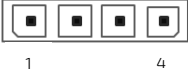
|   | Pin | Signal Name |
|---|-----|-------------|
|  | 1   | +12 V       |
|   | 2   | GND         |
|   | 3   | GND         |
|   | 4   | +12V        |

### 11.2.3. HDD Power Output Connector

Power connector for the drive bay.

|   | Pin | Signal Name |
|---|-----|-------------|
|  | 1   | +12 V       |
|   | 2   | GND         |
|   | 3   | GND         |
|   | 4   | +5V         |

### 11.2.4. SATA1 and SATA2 Port Connector

Data connector for the drive bay.

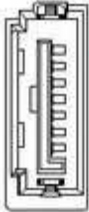
|   | Pin | Signal Name |
|---|-----|-------------|
|  | 1   | GND         |
|   | 2   | TX+         |
|   | 3   | TX-         |
|   | 4   | GND         |
|   | 5   | RX+         |
|   | 6   | RX-         |
|   | 7   | GND         |

### 11.2.5. Serial Port 1 and Serial Port 2 Connector

Both serial ports are RS232, RS422 and RS485 configurable in the BIOS setup menu Advanced>Super IO configuration>Serial port # configuration>Serial port # Type> RS232, RS422, RS485.

|   | Pin | RS232 | RS422 | RS485 Half Duplex | RS485 Full Duplex |
|---|-----|-------|-------|-------------------|-------------------|
|  | 1   | DCD   | Tx-   | Data-             | Tx-               |
|   | 2   | DSR   |       |                   |                   |
|   | 3   | RXD   | Tx+   | Data+             | Tx+               |
|   | 4   | RTS   |       |                   |                   |
|   | 5   | TXD   | RX+   |                   | RX+               |
|   | 6   | CTS   |       |                   |                   |
|   | 7   | DTR   | RX-   |                   | RX-               |
|   | 8   | RI    |       |                   |                   |
|   | 9   | GND   | GND   | GND               | GND               |
|   | 10  | +5V   | +5V   | +5V               | +5V               |

### 11.2.6. USB 2.0 Port Pin Header

|  | Pin | Signal Name | Pin | Signal Name |
|--|-----|-------------|-----|-------------|
|  | 1   | +USBVCC     | 2   | +USBVCC     |
|  | 3   | USB_A-      | 4   | USB_B-      |
|  | 5   | USB_A+      | 6   | USB_B+      |
|  | 7   | GND         | 8   | GND         |
|  | 9   | KEY         | 10  | GND         |

### 11.2.7. Audio Input/Output Pin Header

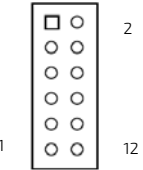
|   | Pin | Signal Name  | Pin | Signal Name |
|---|-----|--------------|-----|-------------|
|  | 1   | Mic-In_L     | 2   | MIC-In_R    |
|   | 3   | Mic-In_JD#   | 4   | GND         |
|   | 5   | Line-In_L    | 6   | Line-In_R   |
|   | 7   | Line-in_JD#  | 8   | GND         |
|   | 9   | Line-Out_L   | 10  | Line-Out_R  |
|   | 11  | Line-Out_JD# | 12  | GND         |



Audio is an option and not connected as standard.

### 11.2.8. Left Channel 3W Audio AMP Output Connector

Speaker output left.

|   |   | Pin | Signal Name |
|---|---|-----|-------------|
|  | 1 | 1   | Speaker+    |
|   | 2 | 2   | Speaker-    |

### 11.2.9. Right Channel 3W Audio AMP Output Connector

Speaker output right.

|   |   | Pin | Signal Name |
|---|---|-----|-------------|
|  | 1 | 1   | Speaker+    |
|   | 2 | 2   | Speaker-    |

### 11.2.10. Power-on Switch Pin Header

Connects to the front panel's Power-on switch.

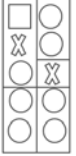
|  |   | Pin | Signal Name | Pin | Signal Name    |
|--|---|-----|-------------|-----|----------------|
|  | 1 | 1   | Power LED + | 2   | Power Button + |
|  | 3 | 3   | NC          | 4   | Power Button - |
|  | 5 | 5   | Power LED - | 6   | SMBALERT#      |
|  | 7 | 7   | BatLow#     | 8   | SMBus DATA     |
|  | 9 | 9   | GND         | 10  | SMBus Clock    |
|  | 2 | 4   | 6           | 8   | 10             |

### 11.2.11. USB Power Selection Jumper/SIM Card Jumper

Jumper selects the USBVCC for the USB 2.0 port.

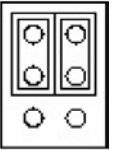
|   |   | Jumper | Setting   | Status               |
|---|---|--------|-----------|----------------------|
|  | 1 |        | 1-3 short | SIM card to NGFF     |
|   |   |        | 3-5 short | SIM card to mPCIE    |
|   | 2 |        | 2-4 short | S3 USB power support |
|   |   |        | 4-6 short | S5 USB power support |



## 12/ BIOS

The KBox A-150-KBL uses the AMI uEFI BIOS supported by the SBC and based on the Unified Extensible Firmware Interface (uEFI) specification and the Intel® Platform Innovation Framework for EFI. The AMI uEFI BIOS preferences are preset and do not require further adjustment for operation. Enhanced uEFI BIOS features that are configurable for the KBox A-150-KBL are COMs (RS232, RS422, RS485) and power settings.

The AMI BIOS setup menus and available selection may vary. For specific information on the BIOS for your product, contact [Kontron Support](#).



---

**UEFI only! No legacy support and no Master Boot Record (MBR) installation.**

---



---

**The BIOS features listed in this user guide are open to change and may not be available in the latest version of the BIOS. For the latest BIOS Information, visit [Kontron's Customer Section](#).**

---

### 12.1. Starting the uEFI BIOS

The uEFI BIOS's Setup program provides quick and easy access to the individual function settings for control or modification of the uEFI BIOS configuration. The Setup program allows for access to various functions that include sub-menus with further functions and sub-menus.

To start the uEFI BIOS Setup program, follow the steps below:

1. Switch on the KBox A-150-KBL.
2. Wait until the first characters appear on the screen (POST messages or splash screen).
3. Press the <DEL> key.
4. If the uEFI BIOS is password-protected, a request for password will appear. Enter either the User Password or the Supervisor Password, press <RETURN>, and proceed with step 5.
5. The BIOS setup utility appears in the Main menu

Using the hot key navigation system users can navigate through the BIOS. The hot key legend bar is located at the bottom of the Setup screens. The following table provides a list of navigation hot keys available in the legend bar.

**Table 14: Navigation Hot Keys Available in the Legend Bar**

| Sub-screen | Description   |
|------------|---|
| <F1>       | <F1> key invokes the General Help window  |
| <->        | <Minus> key selects the next lower value within a field   |
| <+>        | <Plus> key selects the next higher value within a field   |
| <F2>       | <F2> key loads previous values  |
| <F3>       | <F3> key loads optimized defaults   |
| <F4>       | <F4> key Saves and Exits  |
| <←> or <↔> | <Left/Right> arrows selects major Setup menus on menu bar, for example, Main or Advanced  |
| <↑> or <↓> | <Up/Down> arrows select fields in the current menu, for example, Setup function or sub-screen   |
| <ESC>      | <ESC> key exits a major Setup menu and enters the Exit Setup menu<br>Pressing the <ESC> key in a sub-menu displays the next higher menu level |
| <RETURN>   | <RETURN> key executes a command or selects a submenu  |

## 12.2. Setup Menus

The Setup utility features menus listed in the selection bar at the top of the screen are:

- ▶ Main
- ▶ Advanced
- ▶ Power
- ▶ Boot
- ▶ Security
- ▶ Save & Exit

The current active menu and active BIOS Setup item are highlighted in white. Use the left and right arrow keys to select the Setup menus.

Each Setup menu is made up of two main frames. The left frame displays all available functions. Configurable functions are displayed in blue. Functions displayed in grey provide information about the status or the operational configuration. The right frame displays an explanation of the respective function in a help window.

### 12.2.1. Main Setup Menu

Figure 36: Main Setup Menu Example

| Aptio Setup Utility – Copyright (C) 2018 American Megatrends, Inc. |          |                          |      |                        |             |
|--|----------|--------------------------|------|------------------------|-------------|
| Main   | Advanced | Power                    | Boot | Security               | Save & Exit |
| Product Information  |          |                          |      |                        |             |
| Product Name   |          | ECX-KLU1                 |      |                        |             |
| BIOS Version   |          | R1.10 (x64)              |      |                        |             |
| BIOS Build Date  |          | 03/12/2018               |      |                        |             |
| ME Firmware SKU  |          | Corporate SKU            |      |                        |             |
| ME Firmware Version  |          | 11.8.50.3434             |      |                        |             |
| CPU Information  |          |                          |      |                        |             |
| Intel (R) Core (TM) i5-7300U CPU @ 2.60GHz                         |          |                          |      |                        |             |
| Microcode Revision   |          | 84                       |      |                        |             |
| Processor Cores  |          | 2 Core(s) / 4 Threads(s) |      |                        |             |
| Memory Information   |          |                          |      | → ←: Select Screen     |             |
| Total Size   |          |                          |      | ↑ ↓: Select Item       |             |
| Frequency  |          |                          |      | Enter: Select          |             |
| System Date  |          |                          |      | +/-: Change Opt.       |             |
| System Time  |          |                          |      | F1: General Help       |             |
| Access Level   |          |                          |      | F2: Previous Values    |             |
|  |          |                          |      | F3: Optimized Defaults |             |
|  |          |                          |      | F4: Save & Reset       |             |
|  |          |                          |      | ESC: Exit              |             |
| Version 2.18.1263. Copyright (C) 2018, American Megatrends, Inc.   |          |                          |      |                        |             |

The Main Menu provides an overview of the system information and enables users to set the System date and time.

## 12.2.2. Advanced Setup Menu

Figure 37: Advanced Setup Menu Example

| Aptio Setup Utility – Copyright (C) 2018 American Megatrends, Inc. |  |       |           |                        |             |
|--|--|-------|-----------|------------------------|-------------|
| Main   | Advanced   | Power | Boot      | Security               | Save & Exit |
|  | Onboard LAN1 Controller  |       | [Enabled] |                        |             |
|  | Onboard LAN2 Controller  |       | [Enabled] |                        |             |
|  | Audio Controller   |       | [Enabled] |                        |             |
|  | > Display Configuration  |       |           |                        |             |
|  | > Super IO Configuration                                       |       |           |                        |             |
|  | > CPU Chipset Configuration                                    |       |           |                        |             |
|  | > SATA Configuration   |       |           |                        |             |
|  | > USB Configuration  |       |           |                        |             |
|  | > AMT Configuration  |       |           |                        |             |
|  | > Trusted Computing  |       |           |                        |             |
|  | > Network Stack  |       |           |                        |             |
|  | > DIO Configuration  |       |           |                        |             |
|  | > H/W Monitor  |       |           |                        |             |
|  | > Intel (R) I210 Gigabit Network Connection- 00:50:08:0B:2C:24 |       |           |                        |             |
|  | > Intel (R) Ethernet Connection I219-LM – 00:50:08:0B:2C:23    |       |           |                        |             |
|  |  |       |           | → ←: Select Screen     |             |
|  |  |       |           | ↑ ↓: Select Item       |             |
|  |  |       |           | Enter: Select          |             |
|  |  |       |           | +/-: Change Opt.       |             |
|  |  |       |           | F1: General Help       |             |
|  |  |       |           | F2: Previous Values    |             |
|  |  |       |           | F3: Optimized Defaults |             |
|  |  |       |           | F4: Save & Reset       |             |
|  |  |       |           | ESC: Exit              |             |
| Version 2.18.1263. Copyright (C) 2018, American Megatrends, Inc.   |  |       |           |                        |             |

The following table gives more information for important setup options within the Advanced Menu. Default settings are displayed in **bold**.

Table 15: Advanced Menu

| Sub-screen               | Additional Sub-screens with Description |   |                                    |
|--------------------------|---|---|------------------------------------|
| Onboard LAN 1 Controller | [Enabled, Disabled]                     |   |                                    |
| Onboard LAN 2 Controller | [Enabled, Disabled]                     |   |                                    |
| Audio Controller         | [Enabled, Disabled]                     |   |                                    |
| Display Configuration    | Primary Display                         | [Auto, IGFX, PCIE]  |                                    |
|                          | UMA Frame Buffer Size                   | [128MB, <b>256MB</b> , 512MB]   |                                    |
|                          | DVMT Pre-Allocated                      | [ <b>32M</b> , 64M, 96M, 128M, 160M, 192M, 224M, 256M, 288M, 320M, 352M, 384M, 416M, 448M, 480M, 512M, 1024;] |                                    |
|                          | DVMT Total Gfx Mem                      | [128M, <b>256M</b> , MAX]   |                                    |
|                          | Active LVDS                             | [Enabled, Disabled]   |                                    |
| Super IO Configuration   | Serial Port 1 Configuration             | Serial Port   | [Enabled, Disabled]                |
|                          |   | Device Settings   | Read only field<br>IO=3F8h; IRQ=4; |

| Sub-screen                             | Additional Sub-screens with Description |                            |   |
|--|---|----------------------------|---|
| Super IO Configuration (continued)     | Serial Port 1 Configuration (continued) | Change Settings            | [Auto; IO=3F8h; IRQ=4; IO=3F8h; IRQ=3, 4, 5, 6, 7, 9, 10, 11, 12; IO=2F8h; IRQ=3, 4, 5, 6, 7, 9, 10, 11, 12; IO=3E8h; IRQ=3, 4, 5, 6, 7, 9, 10, 11, 12; IO=2E8h; IRQ=3, 4, 5, 6, 7, 9, 10, 11, 12;] |
|  |   | Serial Port 1 Type         | [RS232, RS422, RS485]   |
|  | Serial Port 2 Configuration             | Serial Port                | [Enabled, Disabled]   |
|  |   | Device Settings            | IO=2F8h; IRQ=3; IO=3F8h; IRQ=3, 4, 5, 6, 7, 9, 10, 11, 12; IO=2F8h; IRQ=3, 4, 5, 6, 7, 9, 10, 11, 12; IO=3E8h; IRQ=3, 4, 5, 6, 7, 9, 10, 11, 12; IO=2E8h; IRQ=3, 4, 5, 6, 7, 9, 10, 11, 12          |
|  |   | Change Settings            | [Auto]  |
|  |   | Serial Port Type           | [RS232, RS422, RS485]   |
|  | CPU Chipset Configuration               | EIST                       | [Enabled, Disabled]   |
| Hyper-Threading                        |   | [Enabled, Disabled]        |   |
| VT-d                                   |   | [Enabled, Disabled]        |   |
| Active Processor Cores                 |   | [All, 1]                   |   |
| Intel® (VMX) Virtualization Technology |   | [Enabled, Disabled]        |   |
| C-State                                |   | [Enabled, Disabled]        |   |
| SATA Configuration                     | Serial-Controllers(s)                   | [Enabled, Disabled]        |   |
|  | SATA Mode Selection                     | [Intel RST Premium, AHCI]  |   |
|  | Serial ATA Port 1                       |                            |   |
|  | Port 1                                  | [Enabled, Disabled]        |   |
|  | Serial ATA Port 2                       |                            |   |
|  | Port 2                                  | [Enabled, Disabled]        |   |
|  | M.2 Port 1                              |                            |   |
|  | Port 1                                  | [Enabled, Disabled]        |   |
| USB Configuration                      | Legacy USB Support                      | [Enabled, Disabled, Auto]  |   |
|  | XHCI hand-off                           | [Enabled, Disabled]        |   |
|  | USB Mass Storage Driver Support         | [Enabled, Disabled]        |   |
| AMT Configuration                      | AMT BIOS Feature                        | [Enabled, Disabled]        |   |
|  | Unconfigure ME                          | Read only field [Disabled] |   |

| Sub-screen        | Additional Sub-screens with Description  |  |
|-------------------|--|--|
| TPM Computing     | Security Device Support  | [Enabled, Disabled]<br>Enabled is the customer setting |
|                   | Active PCR Banks (*)   | Read only field<br>SHA-1,SHA256                        |
|                   | Available PCR Banks (*)  | Read only field<br>SHA-1,SHA256                        |
|                   | SHA-1 PCR Bank (*)   | [Enabled, Disabled]                                    |
|                   | SHA256 PCR Bank (*)  | [Enabled, Disabled]                                    |
|                   | Pending Operation (*)  | [None, TPM Clear]                                      |
|                   | Platform Hierarchy (*)   | [Enabled, Disabled]                                    |
|                   | Storage Hierarchy (*)  | [Enabled, Disabled]                                    |
|                   | Endorsement Hierarchy (*)  | [Enabled, Disabled]                                    |
|                   | TPM2.0 UEFI Spec Version (*)   | [TCG_1_2; TCG_2]                                       |
|                   | Physical Presence Spec (*)   | [1.2, 1.3]   |
|                   | TPM 20 Interface Type (*)  | Read only field<br>TIS                                 |
|                   | Additional Info<br>Items marked with (*) are hidden if security device support = disabled. |  |
| Network Stack     | Network Stack  | [Enabled, Disabled]                                    |
|                   | Ipv4 PXE Support   | [Enabled, Disabled]                                    |
|                   | Ipv6 PXE Support   | [Enabled, Disabled]                                    |
|                   | Additional Information<br>Only If "Boot Option Filter = "UEFI only " or "UEFI and Legacy"  |  |
| DIO Configuration | User Configured  | [Enabled, Disabled]                                    |
|                   | DO-1 Value   | [Output Low, Output High, Input]                       |
|                   | DO-2 Value   | [Output Low, Output High, Input]                       |
|                   | DO-3 Value   | [Output Low, Output High, Input]                       |
|                   | DO-4 Value   | [Output Low, Output High, Input]                       |
|                   | DI-1 Value   | [1]  |
|                   | DI-2 Value   | [1]  |
|                   | DI-3 Value   | [1]  |
|                   | DI-4-Value   | [1]  |
|                   | DO-1 Value   | [0]  |
|                   | DO-2 Value   | [0]  |
|                   | DO-3 Value   | [0]  |
|                   | DO-4-Value   | [0]  |

| Sub-screen                             | Additional Sub-screens with Description   |                 |   |
|--|---|-----------------|---|
| H/W Monitor                            | Read only text<br>CPU temperature, memory temperature, System temperature, CPU fan speed, +VCORE, +Vin, +3 VCC, +3 VSB, +VBAT, +5 VA, +3 VA |                 |   |
|  | Smart FAN Configuration   | CPU FAN Setting | [ <b>Manual</b> , Smart]  |
|  |   | Manual Duty     | 255   |
| Intel® I210 Gigabit Network Connection | NIC Configuration   | Auto Negotiated | [ <b>Auto Negotiated</b> , 10Mbps Half, 10 Mbps Full, 100Mbps Half, 100Mbps Full] |
|  |   | Wake On Lan     | [ <b>Enabled</b> , Disabled]  |
|  | Blink LEDS  | 0               |   |
| Intel® Ethernet Connection I219-LM     | NIC Configuration   | Auto Negotiated | [ <b>Auto Negotiated</b> , 10Mbps Half, 10 Mbps Full, 100Mbps Half, 100Mbps Full] |
|  |   | Wake On Lan     | [ <b>Enabled</b> , Disabled]  |
|  | Blink LEDS  | 0               |   |
|  | Link Status   | Disconnected    |   |

### 12.2.3. Power Setup Menu

Figure 38: Power Setup Menu Example

| Aptio Setup Utility – Copyright (C) 2018 American Megatrends, Inc. |          |                       |      |                        |             |
|--|----------|-----------------------|------|------------------------|-------------|
| Main   | Advanced | Power                 | Boot | Security               | Save & Exit |
| Power Configuration  |          |                       |      |                        |             |
| ACPI Sleep State   |          | [S3 (Suspend to RAM)] |      |                        |             |
| Restore AC Power Loss  |          | [Power Off]           |      |                        |             |
| Power Saving Mode  |          | [Disabled]            |      |                        |             |
| Resume Event Control   |          |                       |      |                        |             |
| Resume by LAN Device   |          | [Disabled]            |      |                        |             |
| Resume By PCI-E Device   |          | [Disabled]            |      |                        |             |
| → ←: Select Screen   |          |                       |      |                        |             |
| ↑ ↓: Select Item   |          | [Disabled]            |      | → ←: Select Screen     |             |
| Enter: Select  |          |                       |      | ↑ ↓: Select Item       |             |
| +/-: Change Opt.   |          |                       |      | Enter: Select          |             |
| F1: General Help   |          |                       |      | +/-: Change Opt.       |             |
| F2: Previous Values  |          |                       |      | F1: General Help       |             |
| F3: Optimized Defaults   |          |                       |      | F2: Previous Values    |             |
| F4: Save & Reset   |          |                       |      | F3: Optimized Defaults |             |
| ESC: Exit  |          |                       |      | F4: Save & Reset       |             |
| F4: Save & Reset   |          |                       |      | ESC: Exit              |             |
|  |          |                       |      | F4: Save & Reset       |             |

The following table gives more information for important setup options within the Power Menu. Default settings are displayed in **bold**.

Table 16: Power Setup Menu Sub-screens and Functions

| Function                     | Description                                     |
|------------------------------|---|
| ACPI Sleep State             | Read only field<br>[S3 (Suspend to RAM) ]       |
| Restore AC Power Loss        | [ <b>Power Off</b> , Power On, Last State]      |
| Power Saving Mode            | [EUP Enabled, <b>Disabled</b> , DeepSx Enabled] |
| Resume Event Control         |   |
| Resume by LAN                | [Enabled, <b>Disabled</b> ]                     |
| Resume by PCI-E              | [Enabled, <b>Disabled</b> ]                     |
| Resume By Ring Device        | [Enabled, <b>Disabled</b> ]                     |
| Resume By RTC Alarm          | [Enabled, <b>Disabled</b> ]                     |
| Watchdog Timer Configuration | WDT Function [Enabled, <b>Disabled</b> ]        |

## 12.2.4. Boot Setup Menu

Figure 39: Boot Setup Menu Example

| Aptio Setup Utility – Copyright (C) 2018 American Megatrends, Inc.  |          |  |            |          |             |
|---|----------|--|------------|----------|-------------|
| Main  | Advanced | Power  | Boot       | Security | Save & Exit |
| Boot Configuration  |          |  |            |          |             |
| Full Screen LOGO Display  |          | [Disabled]   |            |          |             |
| Setup Prompt Timeout  |          | 2  |            |          |             |
| Bootup NumLock State  |          | [On]   |            |          |             |
| CSM Support   |          |  | [Disabled] |          |             |
| Boot Option Filter  |          | [UEFI only]  |            |          |             |
| Boot Option Priorities  |          |  |            |          |             |
| Boot Option #1  |          | [Windows Boot Manger<br>(P1:TS32GMTS400I)]                   |            |          |             |
| Boot Option #2  |          | [UEFI: PXE IP4 Intel (R) I210<br>Gigabit Network Connection] |            |          |             |
| Boot Option #3  |          | [UEFI: PXE IP4 Intel (R)<br>Ethernet Connection I219-LM]     |            |          |             |
| → ←: Select Screen<br>↑ ↓: Select Item<br>Enter: Select<br>+/-: Change Opt.<br>F1: General Help<br>F2: Previous Values<br>F3: Optimized Defaults<br>F4: Save & Reset<br>ESC: Exit |          |  |            |          |             |
| Version 2.18.1263. Copyright (C) 2018, American Megatrends, Inc.  |          |  |            |          |             |

The following table gives more information for important setup options within the Boot Menu. Default settings are displayed in **bold**.

Table 17: Boot Setup Menu Sub-screens and Functions

| Function                 | Description  |
|--------------------------|--|
| Full Screen LOGO Display | Full Screen LOGO Display Options:<br>[ <b>Disabled</b> , Enabled]  |
| Setup Prompt Timeout     | Displays number of seconds that the firmware waits for setup activation key The value 65535(0xFFFF) means an indefinite wait. [ <b>2</b> ] |
| Bootup NumLock State     | Selects keyboard NumLock state<br>[ <b>ON</b> , OFF]   |
| CSM Support              | [Enabled, <b>Disabled</b> ]  |
| Boot Option Filter       | [ <b>UEFI only</b> ]   |
| Boot Option #1           | Customer setting is Windows Boot manager   |
| Boot Option #2           | Customer setting is UEFI: PXE IP4 Intel (R) I210 Gigabit Network Connection  |
| Boot Option #3           | Customer setting is UEFI: PXE IP4 Intel (R) Ethernet Connection I219-LM  |



**UEFI only! No legacy support and no Master Boot Record (MBR) installation.**





| Function                        | Description     |  |                             |      |            |
|---------------------------------|-----------------|--|-----------------------------|------|------------|
| Secure Boot Menu<br>(continued) | Key Managaement | Provision Factory Defaults   | [Enabled, <b>Disabled</b> ] |      |            |
|                                 |                 | Install Factory Default keys   |                             |      |            |
|                                 |                 | Enroll Efi Image   |                             |      |            |
|                                 |                 | Save all Secure Boot variables   | Read only field             |      |            |
|                                 |                 | Secure Boot Variable   | Size                        | Key# | Source     |
|                                 |                 | Platform Key (PK)  | 862                         | 1    | Test (AMI) |
|                                 |                 | Key Exchange Keys  | 1560                        | 1    | External   |
|                                 |                 | Authorized Signatures  | 3143                        | 2    | External   |
|                                 |                 | Forbidden Signatures   | 652                         | 77   | Default    |
|                                 |                 | Authorized TimeStamps  | 0                           | 0    | No Key     |
|                                 |                 | OsRecovery Signatures  | 0                           | 0    | No Key     |
|                                 |                 | Additional Information:<br>Only If "Boot Option Filter = "UEFI only " or "UEFI and Legacy" |                             |      |            |

## 12.2.6. Save and Exit Set up Menu

Figure 41: Save and Exit Set up Menu Example

| Aptio Setup Utility – Copyright (C) 2018 American Megatrends, Inc. |          |       |      |                        |             |
|--|----------|-------|------|------------------------|-------------|
| Main   | Advanced | Power | Boot | Security               | Save & Exit |
| Save Changes and Reset   |          |       |      |                        |             |
| Discard Changes and Reset  |          |       |      |                        |             |
| Save Options   |          |       |      | → ←: Select Screen     |             |
| Save Changes   |          |       |      | ↑ ↓: Select Item       |             |
| Discard Changes  |          |       |      | Enter: Select          |             |
| Restore Defaults   |          |       |      | +/-: Change Opt.       |             |
|  |          |       |      | F1: General Help       |             |
|  |          |       |      | F2: Previous Values    |             |
|  |          |       |      | F3: Optimized Defaults |             |
|  |          |       |      | F4: Save & Reset       |             |
|  |          |       |      | ESC: Exit              |             |
| Version 2.18.1263. Copyright (C) 2018, American Megatrends, Inc.   |          |       |      |                        |             |

The following table gives more information for important setup options within the Save and Exit Menu.

Table 19: Save and Exit Setup Menu Sub-screens and Functions

| Function                  | Description   |
|---------------------------|---|
| Save Changes and Reset    | Exits system after saving changes<br>Once you are finished making your selections, choose this option to ensure the values you selected are saved to the CMOS RAM. The CMOS RAM is sustained by an on-board backup battery and stays on even when the PC is turned off. When you select this option, a confirmation window appears. Select <b>[Yes]</b> to save changes and exit.   |
| Discard Changes and Reset | Exits system setup without saving changes<br>Select this option only if you do not want to save the changes that you made to the Setup program. If you made changes to fields other than system date, system time, and password, the BIOS will ask for a confirmation before exiting.   |
| Save Options              | Read only field   |
| Save Changes              | Saves changes made so far for any setup options   |
| Discard Changes           | Discards changes made so far to any of the setup values<br>This option allows you to discard the selections you made and restore the previously saved values. After selecting this option, a confirmation appears. Select <b>[Yes]</b> to discard any changes and load the previously saved values.   |
| Restore Defaults          | Restores/loads standard default values for all setup options<br><u>Load Optimal Default values for all the setup values</u><br>This option allows you to load <b>optimal</b> default values for each of the parameters on the Setup menus, that provides the <b>best performance</b> settings. The F9 key can be used for this operation.<br><u>Load Failsafe Default values for all the setup values</u><br>This option allows you to load failsafe default values for each of the parameters on the Setup menus, that provides the most stable performance settings. The F8 key can be used for this operation. |

## 13/ Technical Support

For technical support contact Kontron's Support department:

- ▶ E-mail: support@kontron.com
- ▶ Phone: +49-821-4086-888

Make sure you have the following information available when you call:

- ▶ Product ID Number (PN)
- ▶ Serial Number (SN)



---

The serial number can be found on the product's type label.

---

### 13.1. Returning Defective Merchandise

All equipment returned to Kontron must have a Return of Material Authorization (RMA) number assigned exclusively by Kontron. Kontron cannot be held responsible for any loss or damage caused to the equipment received without an RMA number. The buyer accepts responsibility for all freight charges for the return of goods to Kontron's designated facility. Kontron will pay the return freight charges back to the buyer's location in the event that the equipment is repaired or replaced within the stipulated warranty period. Follow these steps before returning any product to Kontron.

1. Visit Kontron's [RMA Information website](#).
2. Download the RMA Request sheet for **Kontron Europe GmbH –Ismaning** and fill out the form. Take care to include a short detailed description of the observed problem or failure and to include the product identification Information (Name of product, Product number and Serial number). If a delivery includes more than one product, fill out the above information in the RMA Request form for each product.
3. Send the completed RMA-Request form to the fax or email address given on the RMA Request sheet and Kontron will provide an RMA-Number.
4. The goods for repair must be packed properly for shipping, considering shock and ESD protection.



---

Goods returned to Kontron in non-proper packaging will be considered as customer caused faults and cannot be accepted as warranty repairs.

---

5. Include the RMA-Number with the shipping paperwork and send the product to the delivery address provided in the RMA form or received from Kontron RMA Support.

## 14/ Storage, Transportation and Maintenance

### 14.1. Storage

If the product is not in use for an extended period time, disconnect the power plug from the AC mains power socket .If it is necessary to store the product then re-pack the product as originally delivered to avoid damage. The storage facility must meet the products environmental requirements as stated within this user guide. Kontron recommends keeping the original packaging material for future storage or warranty shipments.

### 14.2. Transportation

To ship the product, use the original packaging designed to withstand impact and adequately protect the product. When packing or unpacking products always take shock and ESD protection into consideration and use an EOS/ESD safe working area.

### 14.3. Maintenance

Maintenance or repair on the open product may only be carried out by Kontron authorized qualified personnel.

Cleaning:

- ▶ For light soiling, clean the product with a dry cloth.
- ▶ Carefully remove dust from the surface of the chassis and heatsink using a clean, soft brush.
- ▶ Stubborn dirt should be removed using a mild detergent and a soft cloth.

#### **NOTICE**

Do not use steel wool, metallic threads or solvents like abrasives, alcohol, acetone or benzene to clean the product.

#### 14.3.1. Replacing the Lithium Battery

The KBox A-150-KBL is equipped with a Kontron specific battery assembly that may need to be replaced during the lifetime of the product. The KBox A-150-KBL is not designed to operate without a battery. If the battery is empty or disconnected, the BIOS settings will be set to the factory defaults.

Replaced the lithium battery only when the KBox A-150-KBL has been shut down properly by using the power-on switch and removing the power cable to disconnect the DC power supply. Replace the Kontron specific battery assembly only with the same type of battery (CR 2032) or with a Kontron recommended battery type.

To replace the Lithium battery, perform the following:

1. Open the KBox A-150-KBL as described in Chapter 6.2: Opening the System (steps 1 to 6)
2. The lithium battery (Figure 42, pos. 1) is attached to the top of one of the internal USB 3.0 connectors (Figure 42, pos. 2) using a double –sided adhesive pad. Carefully, remove the lithium battery from the USB 3.0 connector and disconnect the battery's cable from the on-board battery power input connector (Figure 43, pos. 3)

Figure 42: Lithium Battery Location



- 1 Lithium battery (CR 2032, 3 V) attached to connector with an adhesive pad
- 2 Internal USB 3.0 connector housing

- Replace with a new lithium battery by inserting the battery's connector into the on-board battery power input connector (Figure 43, pos. 3), while paying attention to the polarity of lithium battery connector cables.

Figure 43: Lithium Battery Power Input Connector



- Position the battery cable to ensure that the cables do not interfere with other components and attach the lithium battery to the top of the internal USB 3.0 connector (Figure 42, pos. 2), using a double-sided adhesive pad.
- Open the KBox A-150-KBL as described in Chapter 6.2: Opening the System (step 7)

**CAUTION**

Caution: Risk of Explosion if Battery is replaced by an Incorrect Type. Dispose of Used Batteries According to the Instructions.

ATTENTION: Risque d'explosion si la batterie est remplacée par un type incorrect. Mettre au rebut les batteries usagées selon les instructions.



The KBox A-150-KBL is not designed to operate without a battery. If the battery is empty or disconnected, the BIOS settings will be set to the factory defaults.



Do not dispose of lithium batteries in general trash collection. Dispose of the battery according to the local regulations dealing with the disposal of these special materials, (e.g. to collecting points for battery disposal).

## 15/ Warranty

Kontron defines product warranty in accordance with regional warranty definitions. Claims are at Kontron's discretion and limited to the defect being of a material nature. To find out more about the warranty conditions and the defined warranty period for your region, following the steps below:

1. Visit Kontron's [Term and Conditions webpage](#).
2. Click on your region's General Terms and Conditions of Sale.

---

**NOTICE****Protection label**

The KBox A-150-KBL is factory configured to meet customer requirements and then sealed with a protection label. Opening the KBox A-150-KBL invalidates the warranty and may cause damage to internal components.

---

### 15.1. Limitation/Exemption from Warranty Obligation

In general, Kontron shall not be required to honor the warranty, even during the warranty period, and shall be exempted from the statutory accident liability obligations in the event of damage caused to the product due to failure to observe the following:

- ▶ General safety instructions within this user guide
- ▶ Warning labels on the product and warning symbols within this user guide
- ▶ Information and hints within this user guide

Additionally, alterations or modifications to the product that are not explicitly approved by Kontron, described in this user guide, or received from Kontron Support as a special handling instruction will void your warranty.

Within the warranty period, the product should only be opened by Kontron. Removing the protection label and opening the product within the warranty period exempts the product from the statutory warranty obligation.

Due to their limited service life, parts that by their nature are subject to a particularly high degree of wear (wearing parts) are excluded from the warranty beyond that provided by law.

## Appendix: List of Acronyms

Table 20: List of Acronyms

|               |   |
|---------------|---|
| <b>AC</b>     | Alternating Current                                     |
| <b>ACPI</b>   | Advanced Configuration Control Interface                |
| <b>CPU</b>    | Central Processing Unit                                 |
| <b>DC</b>     | Direct Current  |
| <b>DIO</b>    | Digital Input/Output                                    |
| <b>DP</b>     | Display Port  |
| <b>ECC</b>    | Error Checking and Correction                           |
| <b>EHCI</b>   | Enhanced Host Controller Interface                      |
| <b>ESD</b>    | Electrostatic Discharge                                 |
| <b>GbE</b>    | Gigabit Ethernet  |
| <b>GPU</b>    | Graphics Processing Unit                                |
| <b>HD/HDD</b> | Hard Disk /Drive  |
| <b>HDMI</b>   | High Definition Multimedia Interface                    |
| <b>HPM</b>    | PICMG Hardware Platform Management specification family |
| <b>H/W</b>    | Hardware  |
| <b>IOL</b>    | IPMI-Over-LAN   |
| <b>IOT</b>    | Internet of Things                                      |
| <b>KVM</b>    | Keyboard Video Mouse                                    |
| <b>LAN</b>    | Local Area Network                                      |
| <b>LVD</b>    | Low Voltage Device                                      |
| <b>M.2</b>    | Next smaller generation of mSATA                        |
| <b>MEI</b>    | Management Engine Interface                             |
| <b>mPCIe</b>  | Mini PCI-Express  |
| <b>mSATA</b>  | Mini SATA   |
| <b>OS</b>     | Operating System  |

|              |  |
|--------------|--|
| <b>PCIe</b>  | PCI-Express  |
| <b>PSU</b>   | Power Supply Unit                                      |
| <b>RAM</b>   | Read Access Memory                                     |
| <b>RoHS</b>  | Restriction of the use of certain hazardous substances |
| <b>RTC</b>   | Real Time Clock  |
| <b>SATA</b>  | Serial-ATA   |
| <b>SBC</b>   | Single Board Computer                                  |
| <b>SEL</b>   | System Event Log                                       |
| <b>SELV</b>  | Safety Extra Low Voltage                               |
| <b>SIO</b>   | Super Input/output                                     |
| <b>SMBus</b> | System Management Bus                                  |
| <b>SMWI</b>  | System Monitor Web Interface                           |
| <b>SOL</b>   | Serial Over LAN  |
| <b>SSD</b>   | Solid State Drive                                      |
| <b>TPM</b>   | Trusted Platform Module                                |
| <b>UEFI</b>  | Unified Extensible Firmware Interface                  |
| <b>USB</b>   | Universal Serial Bus                                   |
| <b>VGA</b>   | Video Graphics Array                                   |
| <b>VLP</b>   | Very Low Profile                                       |
| <b>WEEE</b>  | Waste Electrical and Electronic Equipment              |
| <b>WLAN</b>  | Wireless LAN   |
| <b>XHCI</b>  | eXtensible Host Controller Interface                   |





## About Kontron

Kontron is a global leader in IoT/Embedded Computing Technology (ECT). Kontron offers individual solutions in the areas of Internet of Things (IoT) and Industry 4.0 through a combined portfolio of hardware, software and services. With its standard and customized products based on highly reliable state-of-the-art technologies, Kontron provides secure and innovative applications for a wide variety of industries. As a result, customers benefit from accelerated time-to-market, lower total cost of ownership, extended product lifecycles and the best fully integrated applications.

For more information, please visit: [www.kontron.com](http://www.kontron.com)



## Global Headquarters

### Kontron Europe GmbH

Gutenbergstraße. 2  
85737 Ismaning  
Germany  
Tel.: + 49 821 4086-0  
Fax: + 49 821 4086-111  
[info@kontron.com](mailto:info@kontron.com)